

The Automation Book

A world of solutions



**Global service & support / Innovative solutions /
Standards driven / Improving financial performance**

Global impact of Mitsubishi Electric



Through Mitsubishi Electric's vision, "Changes for the Better" are possible for a brighter future.

Changes for the Better



We bring together the best minds to create the best technologies. At Mitsubishi Electric, we understand that technology is the driving force of change in our lives. By bringing greater comfort to daily life, maximising the efficiency of businesses and keeping things running across society, we integrate technology and innovation to bring changes for the better.

Mitsubishi Electric is involved in many areas including the following

■ Energy and Electric Systems

A wide range of power and electrical products from generators to large-scale displays.

■ Electronic Devices

A wide portfolio of cutting-edge semiconductor devices for systems and products.

■ Home Appliances

Dependable consumer products like air conditioners and home entertainment systems.

■ Information and Communication Systems

Commercial and consumer-centric equipment, products and systems.

■ Industrial Automation Systems

Maximising productivity and efficiency with cutting-edge automation technology.

Contents

Introduction to Mitsubishi	4	
Applications in action	6	
Tomorrow's quality, today's goals	12	
European Service	14	
Automation solutions	16	
Controllers/PLCs	20	
HMI/GOTs/Software	22	
Inverters	24	
Motion control	26	
Robots	28	
Low voltage switchgears	30	
Application solutions	32	

Section 2: Technical Information

Global partner. Local friend.

Present right through Europe



An open working relationship between supplier and customer gets results faster and more efficiently.

From the development of products to the management of entire plants, our experience in the industrial market spans more than 80 years. The knowledge we have built up over the decades and our complete product portfolio allow us to work together with customers to create complete turnkey solutions that meet all specific needs. With a globe-spanning service network, we not only provide after-sales service, but also training and technical consultation.

Global partner, local friend

Mitsubishi Electric Factory Automation is synonymous with innovative, high-quality products. Our programmable logic controllers, drive solutions and industrial robots are among the most powerful on the market, and have been contributing to the success of European manufacturing for over 30 years.

Sales and support, never far away

The Factory Automation division has its own sales organisations in Germany, Great Britain, France, Ireland, Italy, Spain, Russia, Poland and Czech Republic. In addition, we have developed an extensive network of partner companies across the whole of Europe and neighbouring countries.

We coordinate and organise our local support throughout Europe to ensure the highest possible standards. Additional support services are available from our European Development Centre (EDC) and EMC Competence Centre.

Trust and loyalty is as important as products

Collaboration with capable partners in the automation industry is one of the key elements in Mitsubishi Electric's success. Today more than ever, customers expect automation solutions tailored to the specific requirements of their applications. Our partners' expertise in specific industries, coupled with Mitsubishi Electric's innovative automation technology, are the two main ingredients of a successful recipe for made-to-order solutions and perfect customer service.

A focus on service

The customer is always the focus of all our service activities. Our customers get the best possible support from experienced staff, who provide competent advice and help with planning, projects, installation and configuration, training and all automation questions and tasks. Optimized stocks and a central logistics centre ensure fast, efficient deliveries of replacement and spare parts. For fast technical information and support, we handle questions from customers all over Europe via our telephone hotline.

Setting the standards

Mitsubishi Electric has a reputation for producing high quality products. This comes, in part, from our commitment to understanding and meeting the requirements of international standards and directives. In addition to European CE compliance, many products also have additional approvals such as:

- e-mark, for use in vehicles
- Shipping approvals like ABS, DNV, GL, RINA, BV, Lloyd's register
- International approvals like UL (USA), cUL (Canada) and GOST (Russia)

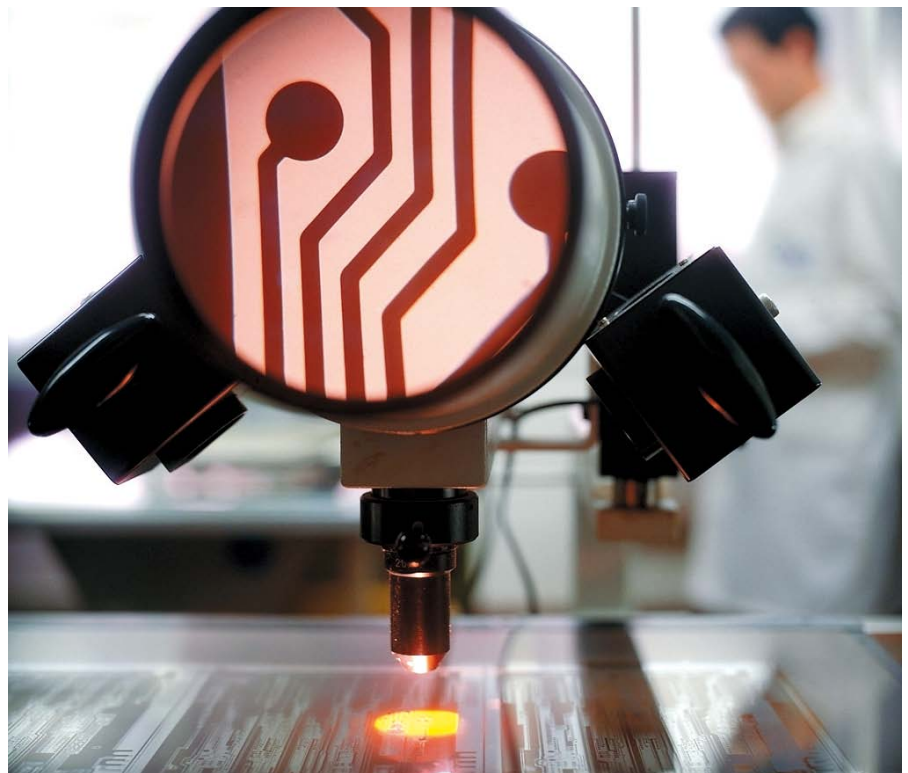

Attention to detail leaves little to chance.

Market leaders

In the world of manufacturing, change is omnipresent. To ensure our products reflect the current needs of customers, we base every aspect of product development and production on the voice of the market. To keep our high levels of product reliability, we incorporate a quality control program that leaves nothing to chance, resulting in the high level of quality synonymous with the Mitsubishi Electric name.

Mitsubishi Electric products are widely regarded as being among the most innovative in the industry. In terms of volume, one in three PLCs in the world today is a Mitsubishi.

Indeed, some of our competitors use Mitsubishi Electric's innovative power management technology in their own frequency inverters.

When all these factors are taken together, it is no wonder our customers think of Mitsubishi Electric's automation products as leading the market.

Water



Application in action

Company: Klinting Vandvaerk

Location: Denmark

Automation specialist:

PRO/AUTOMATIC

Application: Water pumping station

Products: Mitsubishi Electric modular PLCs, frequency inverter drives, Wago remote I/Os

Network: CC-Link

Note:

Bore holes were up to 1.2 km away from the main water station.

Comment:

"It was easy to create the network systems and it has some very powerful unique features."

Jean Petersen PRO/AUTOMATIC

Water is a critical element of life. Without a constant, clean supply for drinking and washing and effective handling of grey waste, society quickly breaks down. Automation solutions need to be reliable and flexible to meet the changing demands of the public but also the pressures to deliver shareholder value. That is why so many utility companies use Mitsubishi Electric.

Food



The range of food available to the consumer today is vast, from ready prepared salads to pre-cooked pies and frozen meats. Much of it comes from far off places but must be processed and delivered on time, every time. Because food is so important to our daily lives there are strict rules and guidelines regarding traceability, labelling, packaging and quality control. Mitsubishi Electric has expertise in all of these areas.

Application in action

Company: Virgin Trading (Virgin Cola)

Location: Ireland

Automation Specialist: Charles Wait

Application: Manufacture of cola concentrate

Products: Mitsubishi Electric software and modular PLCs

Note:

Production facility built to be one of the most efficient in the world with an on-site staff of 6 producing up to 2 billion litres of Cola per year

Comment:

"We chose Mitsubishi Electric ... because of their reputation for reliability and worldwide support particularly in the food and beverage industry."

Rod Golightly, Charles Wait

Manufacturing

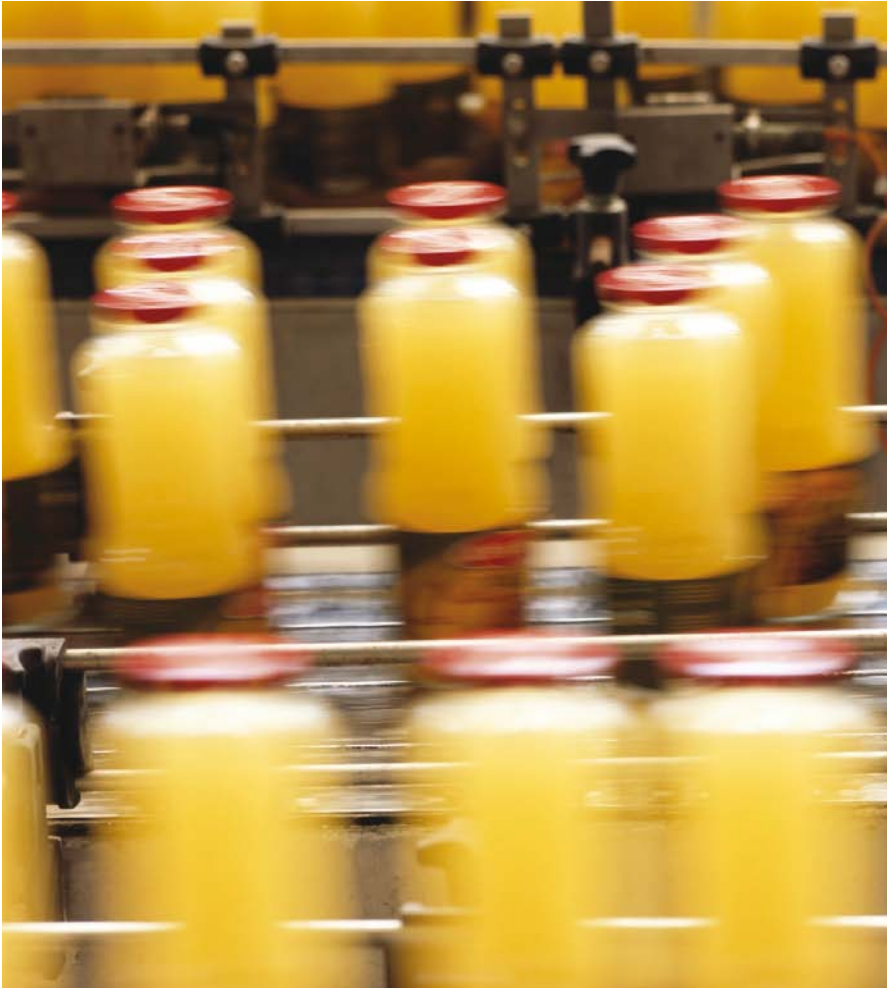

Application in action

Company: Kaba Group

Location: Austria

Application: Manufacture of keys

Products: Mitsubishi Electric robots

Note:

Two robots are used, one to place the brass workpiece in to the milling machine while a second Robot picks up machined keys and applies the final finish from a rotating brush.

Comment:

"Thanks to the use of the robot we were able to reduce costs and significantly improve the transit time."
Robert Weninghofer Production Manager at Kaba

Manufacturing, like all engineering fields, is constantly under pressure to deliver innovative products in the most cost effective way. Generally, manufacturers are looking for suppliers who offer automation solutions that support the wide variety of standards they need, as well as offering flexibility, availability and reliability. This is one reason why the world's manufacturers have bought more than twelve million Mitsubishi Electric FX family PLCs since their introduction over 30 years ago.

Automotive

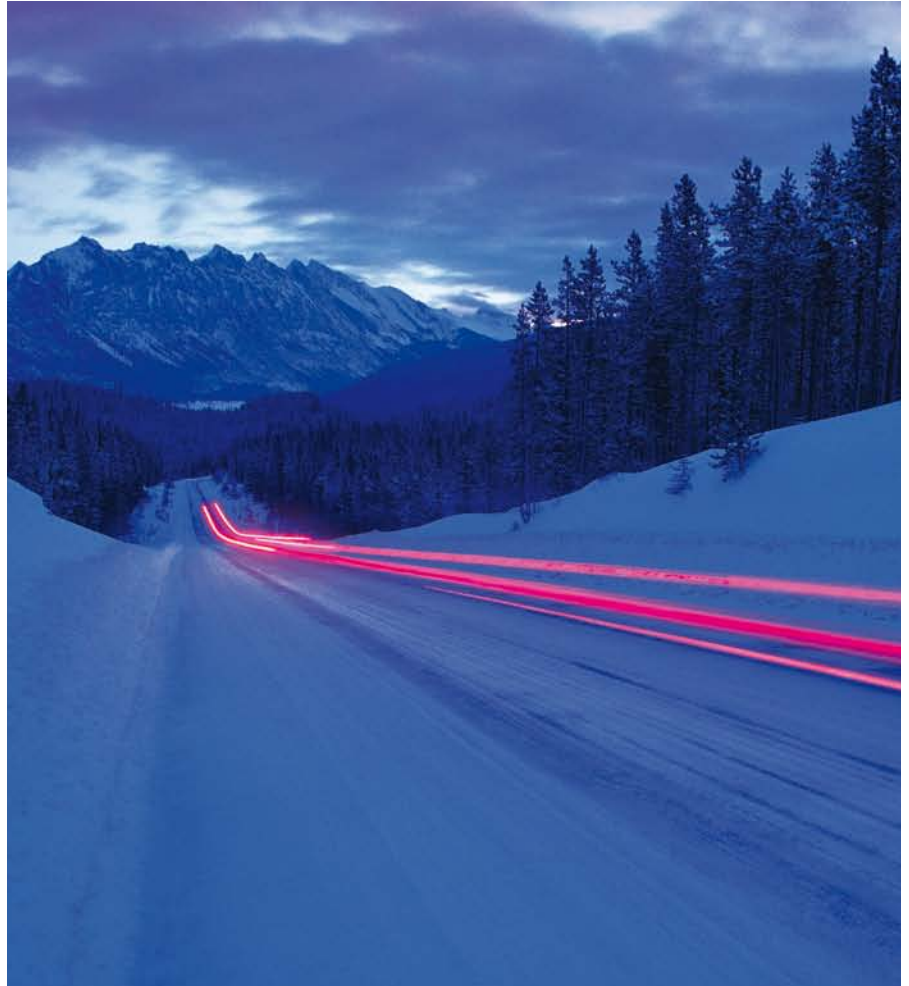

Shorter production cycles, adaptive manufacturing and integration of all areas in the manufacturing process are what make the automotive industry one of the most high power, high pressure, manufacturing sectors in the world.

This is also why these global brands turn to Mitsubishi Electric for the highest level of automation expertise.

Application in action

Company: Global Engine Manufacturing Alliance (GEMA)

Location: USA

Application: Manufacture of automotive engines

Products: Mitsubishi Electric modular PLCs, HMI control units, servo amplifiers, CNC controllers and software

Note:

GEMA is an alliance of the Chrysler Group, Mitsubishi Motors and Hyundai Motor Co. There are two facilities which will, together, produce up to 840,000 engines per year.

Comment:

The Chrysler Group estimates that they will save annual costs of around 100 million dollars per year with the new automation concept.

Chemical



Application in action

Company: Follmann & Co.

Location: Germany

Application: Adhesive manufacture

Products: Mitsubishi Electric compact PLCs, HMI control units, frequency inverter drives

Networks: Ethernet + Fieldbus

Note:

The system has control over the manufacturing process for processes for 17 different adhesives

Comment:

"This economical alternative to centralised process control technology makes all functions and process and production data transparent, from the source up to the management Level."

Axel Schuschies Works Manager

The chemical and pharmaceutical industries are among the world's most competitive, facing tough "speed to market" issues. New products developed in the laboratory have to be rushed into production. To do this safely, quickly and reliably, manufacturers need flexible automation solutions that support a wide range of standards. Mitsubishi Electric automation products answer these needs.

Process



Many automated applications are a continuous process. They vary widely, ranging from power stations to waste incineration. However, all share a need for highly reliable systems. Moreover, control and management of operational waste is an issue undergoing greater regulation through directives such as IPPC. Mitsubishi Electric developed its MELSEC System Q specifically to meet these requirements.

Application in action

Company: European Vinyls Corporation (EVC)

Location: United Kingdom

Automation specialist: Tritec

Application: Combined Heat and Power (CHP) plant

Products: Mitsubishi Electric modular PLCs and software

Note:

Dual redundant PLC solution cost 25 % of traditional DCS solution. Installed system now saves £500,000 (approx. €530k) per year. Payback for the control system was 6 months.

Comment:

"The PLC control system we developed had a system cost of around £0.25m, compared to £1m or more for a conventional system."

Tim Hartley, Tritec

Tomorrow's quality ...



Tomorrow's technology requires investment today

for a greener tomorrow



Eco Changes – for a greener future

Eco Changes is an expression of Mitsubishi Electric's commitment to environmental management. The programme is directed towards a greener future, achieved with innovative environmental technologies and manufacturing expertise. Mitsubishi Electric's goal is to help create an ecological society by means of a broad spectrum of technologies and solutions for private households, offices, businesses, infrastructure and even space exploration. As a global company, we intend to make a key contribution to achieving the goal of a world with low carbon dioxide emissions and high recycling rates.

... today's goals



No matter what the application, the industry or a company's size, Mitsubishi Electric offers its customers the best service possible. This involves getting to know and understand the customer's needs, and being responsive to changing legal and social attitudes in order to develop products required tomorrow, in one year, or in five years.

R&D – lifeblood of the future

Research and development is the lifeblood of Mitsubishi Electric. Our research and development centres in Japan, the United States and in Europe are working on innovative technologies today for the breakthrough products of tomorrow. Mitsubishi Electric invests approximately 4 % of sales in developing tomorrow's technologies.

In a variety of ways, putting programmes and systems into place that help us get closer to our goal of actualizing a sustainable planet. From procurement to product design and manufacturing to logistics

these activities demonstrate how environmentally conscious thinking and action are steadily becoming ingrained in our corporate culture.

Helping the environment

It's all about balance: the balance between effective use of resources, efficient use of energy, and safeguards against potentially harmful substances.

This insight into the balance between efficient automated manufacture and care for our environment helps us to better understand the needs of our customers. For example, the need to monitor and control waste in accordance with the European Integrated Pollution Prevention Control (IPPC) directive.

This is an immense challenge, but one that Mitsubishi Electric is actively pursuing on a daily basis, while keeping focused on one goal. That goal is a global society where life can continually improve in harmonious coexistence with the natural environment.

And so Mitsubishi Electric factories work to ensure full ISO 14000 compliance, and to produce products with fewer harmful substances.



Working for a sustainable future.

Product and service



Technical support is about getting the right answers first time.

When choosing an automation partner our customers look at many different factors, from company stability to market-leading products. Yet one thing they are all interested in is service and support.

Service in Europe

Networks, technology centres and partners spanning Europe ensure outstanding local support services.

The human element



Reliable technical support is only a call away

Our customer hotline supports both current and older product lines. Local engineers then provide telephone support in native languages.

This local service can also provide in-depth technical support when necessary. Thanks to this mix of local and centralized support customers can always be sure they can get the support they need, when they need it.

Complementing our local support, the website www.mitsubishi-automation.com offers MyMitsubishi users access to manuals, CAD drawings, HMI drivers, GSD files etc. for free.



All repairs are carried out by qualified and experienced engineers.

Minimizing downtime

Downtime caused by an operational failure is never good news. In today's tough business environment returning to full production as soon as possible is critical.

Our comprehensive services will help you to get your plant up and running again fast, keeping expensive downtime to a minimum.



Comprehensive training programs

Training for performance

Dealing with complex automation equipment in a fast-paced manufacturing environment requires well-trained personnel. Mitsubishi Electric offers the latest automation training in the use and maintenance of automation systems. This ensures optimum operating performance.

Automation solutions ...



Micro PLCs

The world's favourite micro PLC brings together power and simplicity in equal measure.



Modular PLCs

The MELSEC L Series and MELSEC System Q are high-performance modular controllers. With a wealth of integrated functions, they enable configuration of optimum solutions for all automation tasks.



MELSOFT

Productivity tools and software solutions to help you get the best out of your automation investment.



HMIs, GOTs and IPC

Mitsubishi Electric offers what is probably the biggest range of control terminals and industrial PCs (IPCs) available from any single manufacturer.



Inverters

Mitsubishi Electric has a reputation for reliable inverters, which makes it easy for customers to "Fit and Forget".



ERP
Enterprise Resource Management

Operation

PLANT
Plant Integration Level

Manufacturing

MELSOFT Mitsubishi Integrated FA Software

EZ
EZ Socket

Automation

SHOP FLOOR

Automation solutions ...

TOP FLOOR
(Operation & Planning)

& Planning

MES
Manufacturing
Execution System

Execution System

 **Mitsubishi
EZSocket
Partner Products**

EZSocket
Mitsubishi
Communication Software

Solutions

e-F@ctory

e-F@ctory is the Mitsubishi Electric solution for improving the performance of any manufacturing enterprise, providing three key benefits: Reduced total cost of ownership (TCO), Maximized productivity, and Seamless integration.



Motion Control

Mitsubishi Electric Servo and Motion systems offer scalable solutions from 1 to 96 axes.



Robots

MELFA robots offer class leading technology for both SCARA and articulated arm systems.



LV Switchgear

Advanced low voltage technology covering switchgear and circuit breakers.



CNC Control

Maximise your production and control with the utmost reliability.



EDM Machines

Mitsubishi Electric EDM - voted as the "Global Market Leader 2005" by Frost and Sullivan.

The e-F@ctory solution

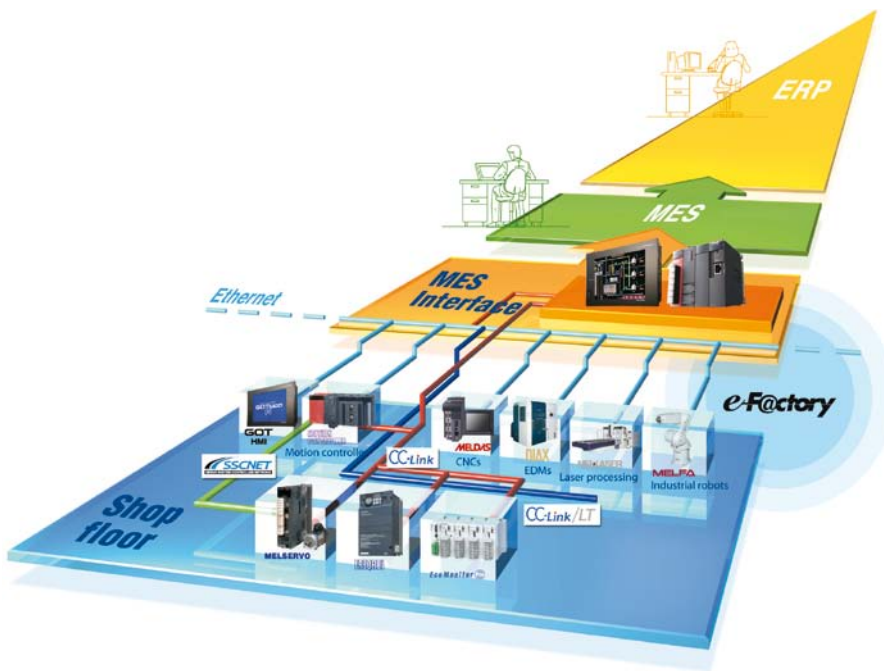

Get maximum system efficiency and performance with e-F@ctory

Our solutions for your benefit

e-F@ctory was born out of the expertise Mitsubishi Electric has developed as a global manufacturing enterprise, facing essentially the same challenges our customers face. Our solution has been implemented in our factories with dramatic results. We are now sharing this expertise with those who are looking for the same benefits from their own manufacturing operations.

An e-F@ctory plant solves various issues through the direct collection of a wide variety of production site data, such as production and operation performance results and quality information, in real-time from equipment and devices, and then utilizes this data in an enterprise IT system.

This real time integration of production data and enterprise IT solidly aids in improving quality, reducing lead time and increasing productivity. The e-F@ctory solution has several key parts as follows.

CC-Link Network Architecture

CC-Link provides a complete open network architecture that links all factory devices. The top layer is CC-Link IE, which provides the first gigabit Ethernet backbone to meet the ever increasing data communication needs of modern factories.

This extends down the hierarchy with CC-Link IE Field, bringing gigabit bandwidth to all devices.

iQ Platform

The iQ Platform is the enabling controller hardware for the e-F@ctory solution. An iQ system unites PLC, motion, CNC, robot and process control in a single unified controller architecture, linked seamlessly by a high speed backplane.

MES Interface

The MES Interface IT products provide the vital link between the shop floor controllers such as the iQ Platform, and the enterprise IT systems. The connection is direct, with no intermediate PC hardware introducing maintenance or security issues.

For more information about Mitsubishi Electric MES interface products please refer to the technical part, chapter 12 in this catalogue.

The e-F@ctory Alliance

A key part of the e-F@ctory solution is the "e-F@ctory Alliance". We have teamed with other best-in-class suppliers to create partnerships that allow our customers to truly benefit from the most comprehensive solutions available. The e-F@ctory Alliance currently has over 28 partners and their number is growing. Current partners include Adroit, Atos Origin, Control Microsystems, CODESYS, Cognex, Copa Data, DP Technology, Emulate3D, eWON, FAG, Felten, HMS, IBHsoftec, ILS Technology, INEA, KH Automation Projects, LEM, mpdv, DATALOGIC, ProLeiT, Raima, RITTAL, RT Leaders, SCHAD, Schaffner, ubigrate, Visual Components, AUVESY, RealTimeLogic.

Safety solutions

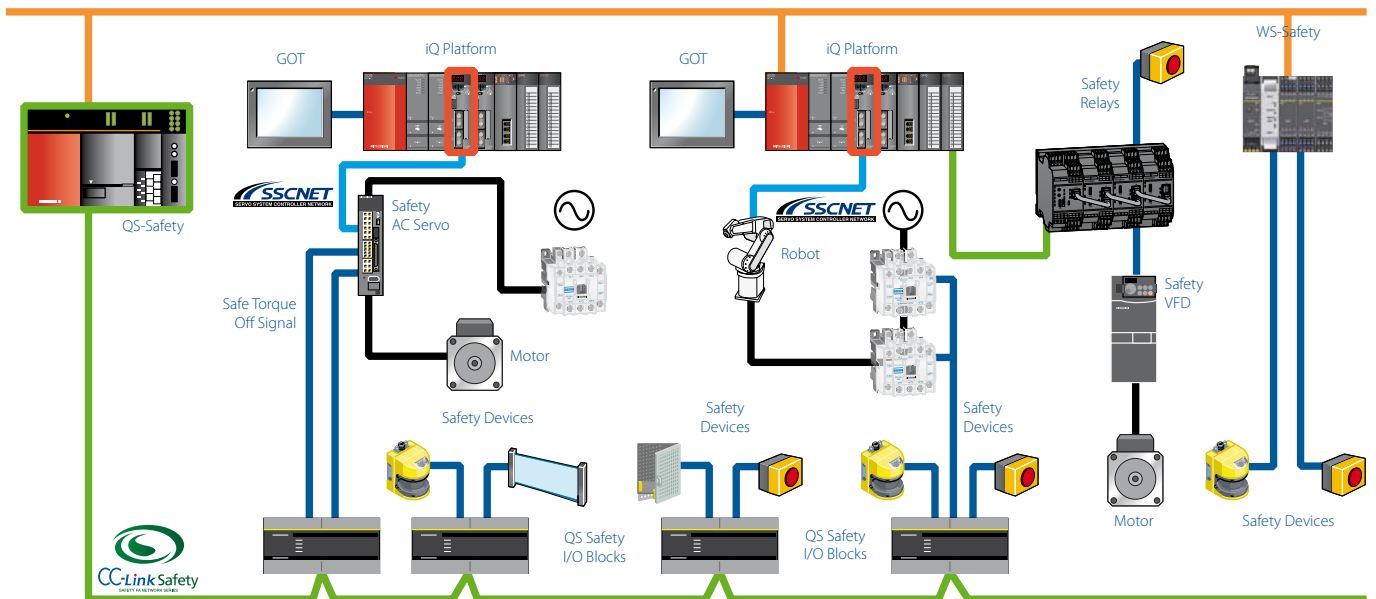

Safety control is fully integrated into the Mitsubishi Electric automation solution

Comprehensive safety solutions

The European Machinery Directive or international standards such as ISO12100 impose strict regulations for the safety of plant and machinery. Just like the machines themselves, the automation systems that control them must also comply with the directives and standards to ensure the safety of personnel in all phases of the machines' service life.

At the same time, the safety concept has shifted from human intervention based "zero accidents" to risk assessment based "zero risk". As a solution for this, Mitsubishi Electric provides a total safety solution by incorporating safety control devices, safety drive devices, and safety components required for safety systems. This allows optimal safety control to be realized, boosting productivity.

Many companies can offer you a choice of safety devices, or perhaps a safety system of some kind. However, few can provide a complete safety solution that fully integrates with the conventional automation of your systems. The result is not only worker, machine and process safety, but industry leading productivity and performance.



Safety in every phase of your production

Please refer to the technical information section of this catalogue for more information and ask for our separately available safety brochure.

Simple, easy, reliable



Proven reliability from standalone to complete installations



One system, one tool

Simple

Mitsubishi Electric PLCs are simple to use. We have reduced many complex actions to a single instruction, making our PLCs much easier to program.

Easy

Moreover, we have designed programming and system configuration to be as flexible as possible. For example, programming tools like GX Developer allow users to quickly create PLC programs and configure new modules.

Complementing these are our GX IEC and GX Works2 programming packages, specially designed for users who wish to use a structured programming standard such as IEC61131-3.

All three packages help to reduce programming costs by allowing users to reuse PLC code they have already created.

In addition, we offer innovative support tools such as GX Simulator. This package permits users to run PLC programs in a simulation mode without any additional hardware, helping to reduce expensive on-site commissioning time.

Reliable

We design and build our PLCs to the highest international standards gaining many marine and specialist approvals in the process. We do this as part of our drive to supply the best quality products possible. A prime example of Mitsubishi Electric quality is the widespread use of our components in the global auto industry, where zero tolerance of product failure is fast becoming the norm.

A unified tool – iQ Works

The iQ Automation Platform is a leading solution for simplified management of complex and heterogeneous industrial production systems. The concept unites PLC, motion, robot and CNC technologies in a single compact hardware platform, enabling seamless interaction between the different control systems. One of the key benefits is the ability to use a single unified tool for development and maintenance of the component systems. iQ Works is that tool: A unified development environment that encompasses all aspects of development and maintenance and can be controlled entirely from a single central location.

PLC Programming							
Package	GX Works 2		GX IEC Developer		GX Developer		AL-PCS/ WIN
	All MELSEC PLCs	FX PLCs	All MELSEC PLCs*	FX PLCs	All MELSEC PLCs	FX PLCs	Alpha Series
Ladder	●	●	●	●	●	●	
Instruction			●	●	●	●	
Function Blocks			●	●			●
Structured Text	●	●	●	●			
SFC	●		●	●	●	●	
IEC61131 Compliant	●	●	●	●			

* except L Series

Control to fit

A wide range of solutions

Mitsubishi Electric PLC and controller solutions are divided into three simple groups.

■ Logic controllers

These Mitsubishi Electric products are called Alpha controllers. They are small compact units with input/output (I/O), CPU, memory, power supply and HMI built into a single unit. The units are programmed with a very intuitive Function Block-style programming tool (AL-PCS/WIN).

■ Micro PLCs

Micro PLCs are widely used in applications ranging from machine control to networked systems. Mitsubishi Electric's famous FX range of PLCs are some of the most popular micro PLCs on the market, as demonstrated by sales of over twelve million controllers worldwide. Micro PLCs contain I/O, CPU, memory and power supply in a single unit.

Moreover, it can extend its capabilities by selecting different options such as I/O, analogue or temperature control. One of the most popular additions is a networking connection. Network options can include Ethernet, Profibus DP, CC-Link, DeviceNet as well as CANopen and AS-interface.

■ Modular PLCs

Modular controllers like Mitsubishi Electric's MELSEC L Series and MELSEC System Q are high-performance PLC systems with broad functionality. The range, power and function of these high-end PLCs is impressive, with operation times measured in nano-seconds. They are equipped with a separate power supply, CPU, I/O and specialist options mounted on a backplane.



Additional backplanes can be added as the system expands. Their modular architecture makes it easy to configure these controllers for any task. Modular PLCs comprise a power supply, one or more CPU modules and I/O and/or special function modules. There Special function modules include analogue, communications and network modules and a special MES interface. A Web server module is also available for Internet access.

The CPU comes with an integrated Ethernet port for easy access to this standard network.

Mitsubishi Electric's MELSEC System Q demonstrates one of the greatest benefits of an automation platform. It makes it possible to integrate PLC CPUs, motion controllers, robot controllers and process CPUs all in a single system. In addition there are options for systems built around industrial PCs, redundant PLCs, as well as a recent innovation, the C controller.



There is a solution to match your needs

■ iQ Platform

Mitsubishi Electric's iQ is the world's first automation platform combining all key automation types on one controller. No longer are valuable engineering resources spent trying to make different systems from separate vendors work together. With iQ, Mitsubishi Electric takes care of system integration. We provide an extensive array of controller types that seamlessly operate together on the same backplane. Now your engineering staff can concentrate on the demands of the application itself right from the beginning.

	Logic controller	Compact PLC	Modular PLC	
	ALPHA2	FX Family	MELSEC L Series	MELSEC System Q
I/O	10-28	10-384	24-4096	32-8192
Memory	200 function blocks	2-64 k steps	20-260 k steps	10-1000 k steps
Cycle period/log. instruction	20 µs	0.065-0.55 µs (65-550 ns)	0.0095-0.040 µs (9.5-40 ns)	0.0095-0.2 µs (1.5-200 ns)

Seeing is believing



Production line or remote plant intelligence – Mitsubishi Electric makes data accessible.



A wide range of open HMI solutions

Mitsubishi Electric's Vision 1000 concept brings together a wide range of human machine interfaces (HMIs) and software solutions that let you see what is really happening in the production process.

Vision 1000

This combination of three visualisation technologies from a single manufacturer, allows users to choose the best solution to fit their requirements.

■ Dedicated HMI solutions

The GOT1000 series of graphic operator terminals provide the very latest in touch-screen display technology. This gives users bright clear display of information with the flexibility of touch screen input.

The GOT units are designed for fundamental integration with Mitsubishi Electric automation technology. This means easier, faster project development as well as increased system performance and additional access to core functions in Mitsubishi's automation hardware.

■ Industrial PC (IPC) solutions

Mitsubishi Electric's range of IPC1000 solutions offer customers a robust platform for developing their own solutions. They are designed to provide the flexibility of high-performance PC power but with a sturdy industrial design to protect them during operation. This means users can install an IPC1000 in their manufacturing environment with complete confidence.

A range of Mitsubishi Electric automation software called MELSOFT supports the IPCs. This provides users with a choice of software components that they can embed in their own solution to complete visualisation packages like SoftGOT1000.

Perfect vision

Hardware with flexibility

When selecting the right visualisation application, a number of basic factors have to be taken into account.

■ Water protection

Vision1000 products from Mitsubishi Electric provide a wide range of solutions catering to virtually every application need. All units have an IP65 ingress protection rating or higher – they can be safely hosed down for cleaning, for example. This is often the case in the food industry where high levels of hygiene have to be maintained at all times.

■ Communication

An important part of automation is communication. This can be implemented at many levels, ranging from a Fieldbus to data networks to remote telemetry solutions using Mitsubishi Electric Industrial Modems.

Vision1000 solutions can connect to leading networks like Ethernet, Profibus and CC-Link. With access to hundreds of drivers, Mitsubishi Electric’s HMI and SCADA solutions can also be used with automation products from other manufacturers.

■ Ease of use

Programming and using Mitsubishi Electric HMIs is easy. All of the packages come with pre-defined graphic libraries to help users get started quickly. More than one hundred drivers are available, making it possible to use Mitsubishi’s HMI solutions with automation products from third-party manufacturers.

MELSOFT

The MELSOFT automation software suite offers users a range of solutions including PLC and HMI programming software components such as OPC servers and Active X containers for embedding directly into a user’s solution.

MAPS (Mitsubishi Adroit Process Suite)

MAPS is an engineering tool that encompasses the entire product life cycle of automation solutions. The benefits of MAPS are already available in the development and integration phases. MAPS also makes it easier to integrate your data and enables customers to install extensions and perform maintenance themselves. The program uses predefined, user-configurable PLC function blocks and SCADA graphics based on the international S88 and S95 standards. This standardisation means that in addition to saving time, MAPS also reduces the development, testing and commissioning overheads of your automation projects. A range of import functions facilitate fast and easy configuration of the user interfaces for both SCADA and PLC projects. MAPS uses a central database for exchanging global variables, making accidental duplication of data records impossible.



Solutions for every visualisation and programming application.

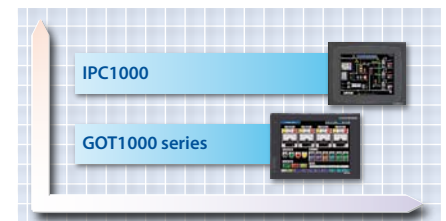

There is a solution to match your needs

HMI Programming/Simulation			
Package	E Designer	GT Designer	
Feature			
Functions: Programming Simulation	•	•	•
Graphics Library	•	•	•
HMI Hardware	E1000 series HMI	GOT1000 series/PC	
Soft HMI Capability		SoftGOT1000	

PC based visualisation				
Feature	Package	PC Control		
	SoftGOT1000	MX Sheet	MX Components	MX OPC
OPC			•	•
Active X			•	
VB/VBA	•	•	•	•
Web Deployable			•	•
ODBC				
Operation: Information Open Plant Factory Floor		•	•	•

Driving performance



Intelligent solutions for every task



Inverters help reduce power consumption and machine wear.

Frequency inverters offer a good example of a widely accepted, widely used automation technology. Inverters allow engineers greater control over a motor's speed and torque performance. Increasingly, inverters are also seen as a simple but important way to reduce energy costs. Today, over 17 million Mitsubishi Electric frequency inverters are in operation around the world in a wide range of applications.

High standards

Our commitment to meeting international standards guides the design of Mitsubishi Electric inverters. Current certifications include the European CE, America's UL and cUL, the Russian GOST, as well as shipping approvals. These certifications help exporters who sell machines and systems with embedded inverters.

Mitsubishi Electric inverters mean reliability and performance. This is why two consecutive IMS Customer Satisfaction Surveys gave Mitsubishi Electric inverters top marks for reliability and technology.

The FR-D700 SC and FR-E700 SC inverter drive series come with the two-channel STO (Safe Torque Off) safety system integrated as standard equipment. This makes it possible to operate multiple inverter drives inexpensively with a single safety relay.

Cut costs

A standard industrial motor in a typical fan or pump application may only cost a few hundred euros to purchase. However, that same motor will consume hundreds of thousands of euros in electricity costs over its operational lifetime. Using an inverter can significantly reduce this outlay.

Intelligent solutions for every task

Mitsubishi Electric offers four types of inverter: Simple, Economy, Flexible and Advanced. Each has been optimized to offer the very best in control and performance.

In addition, depending upon the type selected, Mitsubishi Electric inverters can support the following networks: RS485, ModbusRTU, BacNet, Profibus DP, CC-Link IE Fieldbus, DeviceNet, LONWorks, SSCNET and Ethernet based networks. This extensive communication ability makes it easier to integrate inverter control into larger automation systems.

Powering the future



FR-D700 SC

■ Micro

Mitsubishi Electric's entry level series combines ultra-compact dimensions with a wealth of new functions, including an emergency stop input for reliable stopping. Current vector control ensures that this frequency inverter can always deliver high torque, even at low speeds. An integrated brake transistor enables direct connection of a brake resistor for better braking performance. The FR-D700 SC is the ideal choice for driving fans, agitators and conveyor belt systems.

FR-E700 SC

■ Compact

Improved functions and capabilities make the FR-E700 SC inverters an economical and universal choice for a huge range of applications such as conveyor belts, hoists, stage systems, pumps, fans and extruders. Features include an integrated USB port, safe stop inputs for safety stop function, improved power delivery in the low-speed range, options for controlled shut down and a slot in which you can install one of the many available option cards for the 700 series.



FR-F700

■ Flexible

Many frequency inverter drives save power but the FR-F700 saves more. Its innovative OEC technology (Optimum Excitation Control) ensures that exactly the right magnetic flux is always applied to the motor for maximum motor efficiency and minimum power consumption. FR-F700 inverters are particularly well suited for pump and fan, HVAC and building services applications.

FR-A700

■ Powerful

The frequency inverters of the FR-A700 series deliver high-end performance and power. Their RSV (Real Sensorless Vector control) technology ensures maximum torque and optimum smooth running. For greater flexibility these inverters have four overload ranges, options for controlled shutdown and integrated PLC functions. With their dynamic performance the FR-A700 inverters are ideal for cranes and hoisting gear, high-shelf storage systems, extruders, centrifuges and winding systems.



Comprehensive range from ultra compact to ultra powerful

Among the highlights of this series are the FR-A741 models, which have an integrated regenerative braking system. Up to 100 % of the braking energy can be fed back into the power circuits. No external brake resistor or brake chopper is needed.

Inverter range								
	FR-D700 SC		FR-E700 SC		FR-F700		FR-A700	
	D720S SC	D740 SC	E720S SC	E740 SC	F740	F746	A740	A741
Input voltage	1-phase 200–240 V AC	3-phase 380–480 V AC	1-phase 200–240 V AC	3-phase 380–480 V AC	3-phase 380–500 V	3-phase 380–500 V AC	3-phase 380–500 V	3-phase 380–500 V AC
Output [kW]	0.1–2.2	0.4–7.5	0.1–2.2	0.4–15	0.75–630	0.75–55	0.4–630	5.5–55
Overload	200 %		200 %		200 %, 150 %		120 %, 150 %, 200 %, 250 %	150 %
Rating	IP20		IP20		IP20–00	IP54	IP20–00	IP00

Poetry in motion



Speed, accuracy and control when you need it

As the demands on manufacturing increase, there is a growing need to produce higher quantities of finished goods with lower wastage. To achieve this, all areas of automation are evolving to meet these new demands.

One area undergoing rapid growth is servo and motion control. The development of high performance servomotors combined with intuitive motion control is replacing traditional movement solutions.

Speed and performance

Servomotors allow users to create automation solutions that are faster, more precise and more compact.

Mitsubishi Electric has been pushing forward the boundaries of servomotor design, creating ultra compact brushless motors. All motors of the MR-ES series have an encoder with a resolution of 131,072 pulses per revolution. All motors of the MR-J4 series have an encoder with a resolution of 4,194,304 pulses per second. This permits greater machine speed and accuracy.

Plug and Play

Mitsubishi Electric servo and motion solutions offer easy system building and configuration based on PC "plug and play" concepts.

■ Simple connections

The availability of pre-made cables of different lengths means that connecting a servomotor to an amplifier or any other combination is quick and error free.

■ Automatic motor recognition

When a Mitsubishi Electric servomotor is connected to an amplifier it is automatically recognized. The correct parameters are then automatically loaded, ready for operation. This reduces the set-up time and the chance of errors.

■ Simple networking

High-speed servo and motion applications need special high-speed networking. Mitsubishi Electric's Servo System Controller Network (SSCNETIII/H) provides the system capability, connecting and fully synchronising up to 96 axes using a simple plug and cable construction.

*) The MR-J4 series products use SSCNETIII/H, a fibre based version of the network giving complete noise immunity.

Power and precision



Plug and play technology

Powerful Amplifiers

A wide spectrum of Mitsubishi Electric MR-J4 series amplifiers is available, ranging in power from 100 W to 22 kW for 200 V operation, and 600 W to 22 kW for 400 V systems. With such a wide choice of types and series users are sure to find the solution they need.

■ Performance

With a speed frequency response of up to 2500 Hz Mitsubishi Electric servo systems offer world class performance.

■ Vibration suppression

Machine performance is often limited by mechanical constraints. The built-in vibration suppression of Mitsubishi Electric's amplifiers overcome some of these limitations through precise control, reducing the effect of micro vibrations at the pulse point, helping users to get better more reliable machine performance. This function suppresses not only residual vibrations of the machine but also at the end of an arm.

■ „One-Touch-Tuning“

The new one-touch tuning function minimises time consuming system adjustments between machine and electronics by touching one button. Control parameters are optimised and resonance frequencies of the machine and the mechanics are detected and filtered. An individual adjustment of single applications is not needed. The result is a vibration free, high precise und high speed positioning process – only by one click.



HG motor series – IP65/IP67 standard protection

Motor solutions for all

Featuring the most advanced concentrated winding techniques and the latest technology, Mitsubishi Electric servomotors are among the most compact on the market.

Motors are available in a range of options from 50 W to 110 kW in different designs, including specialised motors such as hollow shaft and pancake designs that suit most application needs.

Moreover, Mitsubishi Electric's low, ultra-low and medium inertia motor designs allow users to select the best motor characteristics for their application.

Motion controllers

Mitsubishi Electric offers a comprehensive range of solutions for positioning tasks and high-end motion control. Options include simple pulse train positioning controllers and dedicated motion cards. And for the most complex applications there are dedicated MELSEC System Q motion CPUs. Users are able to select the type and style of control they are most familiar with, making system construction fast and efficient.

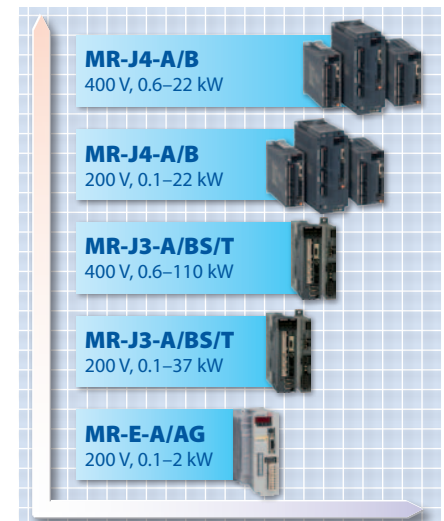

A wide range of powerful amplifiers

Innovation in movement



High speed, high accuracy pick and place applications



Powerful software helps you get the most out of your robot application.

Robots are already widely accepted as a cost-effective solution for high-speed, high-accuracy pick-and-place applications as well as some basic assembly tasks.

€ 1.65/hr

Robot usage can vary widely but an average application over a typical 7-year life cycle can cost as little as € 1.65 per hour to purchase and operate.

BASIC talk

Programming a Mitsubishi Electric robot arm is easier than most people think. The programming language is a BASIC-like structure with commands reflecting the requested action. For example, the command MOV means “move”, HCLOSE means “hand close”. Furthermore, all Mitsubishi Electric robots are programmed using the same language, reducing the user’s learning curve.

Making life easy

With the software RT ToolBox2 all robot models are programmable in a quick and easy way. Imported 3D CAD data, program variables and robot simulations can easily be displayed on the graphical surface of the programming software RT Toolbox2.

This leading edge software allows a robot application to be programmed and its operation simulated before the hardware is purchased. This makes system design and building quicker and easier. Moreover, it can identify potential hazards before robot integration begins.

Advanced control as standard

All Mitsubishi Electric robot controllers are shipped with the full control software as standard. This means users do not need to buy additional task-driven software modules at a later date.

Task driven

Thoughtful design

Due to the new motors developed by Mitsubishi Electric, the high arm rigidity and the unique controller technology the robots of the F series achieve the highest speed in their class.

■ Ease of connection

Mitsubishi Electric robot arms feature a single connection point for power and pneumatics, making setup and commissioning easier.

In addition, each robot has body-mounted compressed air and signal connections mounted locally to the gripper flange for ease of use.

■ Standard gripper plates

All arm gripper mounting flanges are designed and built in accordance with ISO9409-1, ensuring ease of connection to the user's choice of robot hand.

■ Extended axis

All MELFA robots can be mounted on an additional linear axis to provide greater reach and utilization of the robot arm.

■ Networked

Mitsubishi Electric's robot controllers can be embedded into larger automation cells by using networks such as Ethernet, Profibus, Profinet, Ethernet/IP and CC-Link, keeping users in control at every step of their process.

Articulated arm robots

The range of the articulated-arm robots of the RV series starts with the powerful compact class with a payload from 2 kg up to the power pack with a payload of 12 kg. These robots are also available as a long arm version.

Higher handling weights and a larger movement area can be realised by the compact and slim construction of the robot arm. The standard protection class of IP67 allows the operation of the robots in industries like food, beverage and packaging.

SCARA robots

Mitsubishi Electric's range of SCARA robots divides into two categories. The small RP-ADH robots feature outstanding repeatability (± 0.005 mm) at very high speed, making them ideal for micro assembly tasks and the population and soldering of SMD circuit boards.

The robots of the RH-FH series are suitable ex factory for a multitude of industrial applications and can be adopted intersectoral. A cycle time of only 0.29 s for the 12" cycle ensures high precise and powerful operation for increasing productivity on-site. By protection class IP54 and utilisation of lubrication grease suitable for use in food the robots are capable of being fully integrated. The wiring routed inside the robot and led through at the ball screw end offers protection and safety.



Articulated-arm robots have pneumatic hoses and signal connection lines which are routed inside the robot. SCARA robots are particularly suitable for fast palletising also on the fly.

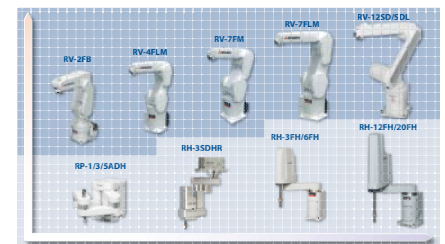

The ideal robots for all applications with payloads of up to 12 kg/20 kg

Robot range			
Range	RP	RH	RV
Type	SCARA	SCARA	Articulated arm
Weight class [kg]	1–5	3–20	2–12
Reach [mm]	236–453	350–1000	504–1385

Breakthrough technology



Groundbreaking research and design



Standards are at the centre of our product development.

Mitsubishi Electric has been active in the low voltage (LV) switchgear market since 1933. Ever since Mitsubishi Electric developed and manufactured the first moulded case circuit breakers, the company has been committed to research and development in this field, making it one of the world's leading manufacturers of circuit breakers.

Innovation

Groundbreaking research and design has resulted in innovative LV switchgear, providing users with greater quality, safety and reliability. Today's LV products feature meticulously designed technology: even the casing material used in the PA (Polymer Ablation type Auto-Puffer) provides greater safety and high voltage breaking performance.

Leading edge

Jet Pressure Trip (JPT) is an extension of the PA concept, allowing switchgear to trip even faster than a traditional magnetic solution. This means that the switchgear can improve its current-limiting performance and circuit breaking reliability. Any connected devices are then better protected, a major benefit to users.

Other technologies such as ISTAC (Impulsive Slot-Type Accelerator, used as a high-speed arc-controlling technology) and developments in digital ETR (Electronic Trip Relay) and VJC (Vapour Jet Control) all contribute to making Mitsubishi Electric's LV products leading edge.

Global products

All LV products are designed to comply with international standards such as IEC, UL/CSA, and JIS.

A complete solution

Mitsubishi Electric offers a complete solution for line and load side distribution, ranging from air circuit breakers to moulded case breakers and magnetic contactors.

■ Air Circuit Breakers (ACBs)

These compact Super AE units come in a broad spectrum of performance categories from 1,000 to 6,300 Amps. The basic unit is available as a fixed or “draw out” design, which can be augmented with options for enhanced overload control, network and energy consumption.

Thanks to these features Mitsubishi Electric’s ACBs provide users with the flexibility to meet most applications.

■ Moulded Case Circuit Breakers (MCCBs)

Mitsubishi Electric’s MCCBs of the World Super Series (WSS) provide protection across the current range from 3 to 1,600 Amps. Each unit is available in a fixed or slot-in design and has a range of additional options such as electronic trips.

■ Magnetic Contactors, Thermal Overload Relays, Contactor Relays

The MS-N range of LV switchgear is a reliable and customizable solution for load side connection. The MS-N range is made up of magnetic contactors, thermal overload relays and contactor relays.

These space-efficient products are up to 25 % smaller than similar units. In addition the MS-N range has enhanced performance. For example, the magnetic contactors withstand voltage drops of up to 35 % while still ensuring reliable operation.

The MS-N units can be customised with a wide range of options, including thermal overload relays, time delay modules, auxiliary contacts and trip indicators to suit the user’s specific needs.



Virtually maintenance free low voltage switchgears

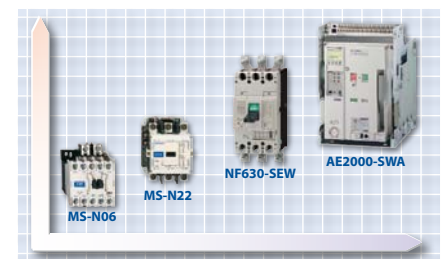

Advanced low voltage technology

Where have Mitsubishi Electric products been used?



Automotive control solutions

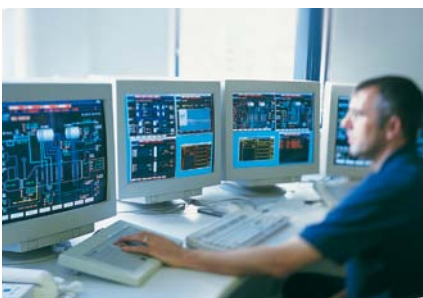

Remote management solutions include SCADA, Networking, Telemetry and Industrial Modems.

Customer applications with Mitsubishi Electric products have been wide spread from critical applications in pharmaceutical industries to sublime applications in the leisure industry.

Here are just a few examples of applications that customers have completed in the past:

- Agriculture
 - Plant watering systems
 - Plant handling systems
 - Sawmill (wood)
- Building management
 - Smoke detection monitoring
 - Ventilation and temperature control
 - Lift (elevator) control
 - Automated revolving doors
 - Telephone management
 - Energy management
 - Swimming pool management

- Construction
 - Steel bridge manufacturing
 - Tunnel boring systems
- Food and drink
 - Bread manufacturing (mixing/baking)
 - Food processing (washing/sorting/slicing/packaging)
- Leisure
 - Multiplex cinema projection
 - Animated mechatronics (museums/theme parks)
- Medical
 - Respiration machine testing
 - Sterilization
- Pharmaceutical/chemical
 - Dosing control
 - Pollution measurement systems
 - Cryogenic freezing
 - Gas chromatography
 - Packaging
- Plastics
 - Plastic welding systems
 - Energy management systems for injection molding machines
 - Loading/unloading machines
 - Blow molding test machines
 - Injection molding machines
- Automotive
- Printing
- Textiles
- Transportation
 - Sanitation on passenger ships
 - Sanitation on rail rolling stock
 - Fire tender pump management
 - Waste disposal truck management
- Utilities
 - Waste water disposal
 - Fresh water pumping
 - Clarification plants



Technical Information Section

More information?

The catalogue at hand is designed to give an overview of the extensive product range of Mitsubishi Electric Europe B.V., Factory Automation. If you cannot find the information you require in this catalogue, there are a number of ways you can get further details on configuration and technical issues, pricing and availability.

For technical issues visit the www.mitsubishi-automation.com website. Our website provides a simple and fast way of accessing further technical data and up to the minute details on our products and services. Manuals and catalogues are available in several different languages and can be downloaded for free.

For technical, configuration, pricing and availability issues contact our distributors and partners. Mitsubishi Electric partners and distributors are only too happy to help answer your technical questions or help with configuration building. For a list of Mitsubishi Electric partners please see the back of this catalogue or alternatively take a look at the "contact us" section of our website.

About this technical information section

This section is a guide to the range of products available. For detailed configuration rules, system building, installation and configuration the associated product manuals must be read. You must satisfy yourself that any system you design with the products in this catalogue is fit for purpose, meets your requires and conforms to the product configuration rules as defined in the product manuals.

© Mitsubishi Electric Europe B.V., Factory Automation - European Business Group

The products of Mitsubishi Electric Europe B.V., that are listed and described in this document, are neither subject to approval for export nor subject to the Dual-Use List.

Overview

1	SOFTWARE	4	1
2	NETWORKS	10	2
3	REMOTE I/O MODULES	18	3
4	MODULAR PLCs	30	4
5	COMPACT PLCs	70	5
6	HMI s	91	6
7	FREQUENCY INVERTERS	102	7
8	SERVO AND MOTION SYSTEMS	119	8
9	ROBOTS	144	9
10	LOW VOLTAGE SWITCH GEARS	153	10
11	MES SOLUTIONS	162	11
12	POWER SUPPLIES	164	12
	Index	165	
	Mitsubishi Electric Internet Portal	166	

Software



Our MELSOFT suite of Automation software is designed to help you integrate your production process and maximise your business potential. MELSOFT embodies a wide range of software to optimise your plant productivity; from visualisation and control systems to historic and downtime monitoring capabilities. A core design feature of our software is that it is scalable. It is a well accepted truism that one solution rarely fits all, so within each application category there are a range of products offering different levels of functionality and connectivity designed to meet your individual needs. All products are based on Microsoft standards (OPC etc), giving you a broad range of connectivity options and a familiar interface. The MELSOFT suite consists of three main areas:

- **Visualisation.** This type of software is aimed at monitoring and controlling your automation processes.
- **Programming.** Our extensive range of programming software enables users to write their own PLC code for their application. We have software solutions for each of the following products groups; Servos, Inverters, Logic Blocks, PLCs, HMIs and Networking.
- **Communication.** Our communication software is designed to integrate our products with common third party software packages. This provides you with the reliability and quality of Mitsubishi Electric hardware, combined with the familiarity of software packages/tools such as Microsoft Excel, ActiveX and OPC.

Unified Engineering Environment: iQ Works

iQ Works integrates the functions necessary to manage every part of the system cycle.

System design

The intuitive system configuration diagram allows for the graphic assembly of systems, centralized management of disparate projects and batch configuration of the entire control system.

Programming

Use system labels to seamlessly share device data between GOTs, PLCs and motion controllers. Save the time and hassle of changing device values in each program by using the update system labels feature.

Test and startup

Debug and optimize programs using the simulation functions. Use the included diagnostics and monitoring functions to quickly identify the source of errors.

Operation and maintenance

Speed up the process of commissioning, configuring and updating the system by using the batch read feature. Virtually eliminate the confusion associated with system management.

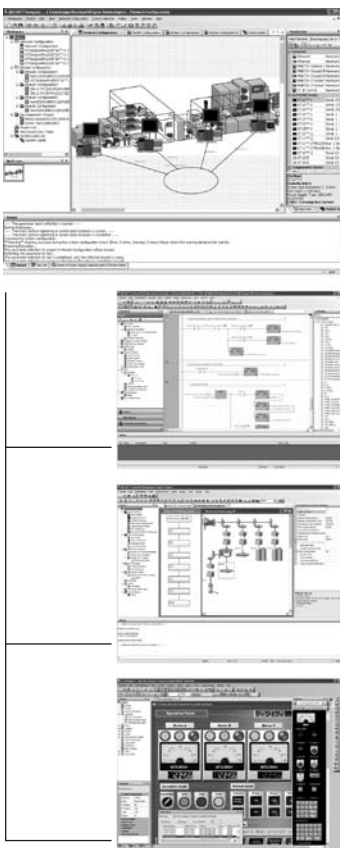

MELSOFT Navigator

is the heart of iQ Works. It enables the effortless design of entire upper-level systems and seamlessly integrates the other MELSOFT programs included with iQ Works. Functions such as system configuration design, batch parameter setting, system labels and batch read all help to reduce TCO.

MELSOFT GX Works2

represents the next generation in MELSOFT PLC maintenance and programming software. Its functionality has been inherited from both GX and IEC Developer, with improvements made throughout to increase productivity and drive down engineering costs.

MELSOFT MT Works2

is a comprehensive motion CPU maintenance and program design tool. Its many useful functions, such as intuitive settings, graphical programming and digital oscilloscope, simulator, different Motion OS support, assistance help, to reduce the MT Works2 associated with motion systems.

MELSOFT GT Works3

is a complete HMI programming, screen creation and maintenance program. In order to reduce the labor required to create detailed and impressive applications, the software's functionality has been built around the concepts of ease of use, simplifications (without sacrificing functionality) and elegance (in design and screen graphics).

Visualisation Software

Soft HMI

GT Works3 (GT SoftGOT1000)



GT Works is a wide-ranging visualisation control tool from Mitsubishi Electric. A major benefit of GT Works is that visualisation screens can be created independently of their final target platform, i. e. a hardware platform such as GOT1000 or a PC based platform such as GT SoftGOT1000.

GT SoftGOT1000 is a PC based HMI module within GT Works. A further benefit of GT SoftGOT1000 is that it inherits the advanced simulation features of GT Works. It can be simulated in a stand-alone configuration or in conjunction with GX simulator, linking both PLC and HMI simulation code for a true integrated approach.

- Advanced simulation of HMI operations and optional HMI/PLC simulation code.
- Platform independent, screens created can be used for SoftHMI or hardware based HMIs.
- Remote monitoring by intranet LAN.

HMI Programming

GT Works3



As part of GT Works, GT Designer is a drawing program designed to create HMI screens for GOT1000 series. A user-friendly Windows environment provides the user with a simple and recognisable interface, reducing the time of their learning curve and the training costs associated with it. The package consists of:

- An extensive picture and graphics library editor that enables you to modify the graphics to meet your exact specifications.
- A tree format of the project gives you an overview of the structure of the project. This gives you the opportunity to navigate through your project and add, delete or move any programs or functions, creating a more logical flow to your menu structure.
- The combination of GT Simulator and GX Simulator allows you to test both the HMI and PLC coding offline, on your PC without the need to connect to physical hardware (also see GT SoftGOT1000).



E Designer

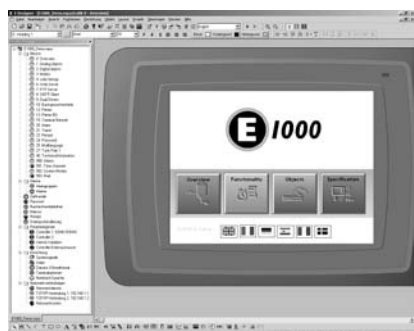

E Designer is a complete PC-based programming software program for the E Series HMIs. Projects are built from menu hierarchies or as sequences, providing the user with an easy to follow logical progression of operations. The main features of E Designer are:

- A pre-defined library of graphics and symbols provides a straightforward and efficient basis to set-up your project, reducing the cost and time of the implementation.
- The use of "Vector Graphics" gives you the flexibility to alter the design of your objects and symbols, and "personalise" them, to meet your individual requirements e.g. a flashing red and yellow graphic can be used to symbolise an alarm sounding, alerting the user of an occurring danger.
- E Designer supports a multi-language set-up. This enables you to program and run your project in a wide variety of languages, including: English, German, French, Spanish, Italian and Japanese.

PLC Programming

GX Works2/GX Works2 FX



GX Works2 is the PLC programming environment of the next generation. It supports all PLC of the MELSEC System Q, L and FX series and offers numerous functions to facilitate programming work and support the user. GX Works2 FX has the same functionality as GX Works2 but just for FX PLC's.

The following programming languages are available:

- ST (Structured Text)
- SFC (Sequential Function Chart)
- LD (Ladder Diagram)
- FBD (Function Block Diagram)
- IL (Instruction List) – planned capability

The main features of GX Works2 are:

- Integrated parameterization of special function modules (analog, temperature, positioning, counter, network)
- Use of program and function block libraries save time for programming and minimizes errors.
- Integrated simulation allows offline testing of the software and the configuration.
- Comprehensive diagnostics and debugging functions support the user in troubleshooting and fault clearance.
- Revision verification and restoration makes it possible to restore old program versions or to compare with programs from the PLC.
- GX Works2 is compatible with GX Developer and GX IEC Developer projects (as far as the editors are supported)

GX Configurator DP



GX Configurator DP is a setup and configuration software for Profibus DP networks. It can be used to configure Mitsubishi Electric Profibus DP master and all slave modules including Inverters and HMI's as well as other manufacturers products.

- Easy to use drag & drop configuration system
- Automatic generation of program modules that can be integrated directly in to the GX IEC Developer package
- Configurations can be transferred via the PLC's programming port or over networks

GX Configurator PN

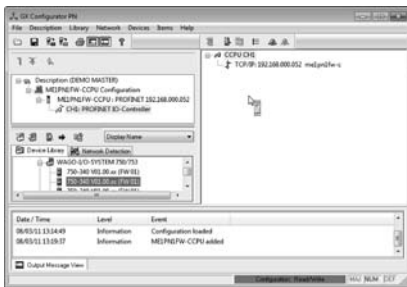

GX Configurator PN is the configuration tool for Profinet I/O modules. This software offers functions for the configuration of the Profinet I/O network, testing the configuration and transfer of the settings to the Profinet module.

- Various capabilities for the transfer of parameter data: Direct connection to the local Profinet module or via a network.
- Easy configuration of Profinet I/O slaves using GSD files provided by the device manufacturer.
- Available as 32 bit version for MS Windows® XP, Vista and MS Windows® 7.

Alpha - ALVLS (AL-PCS/WIN)

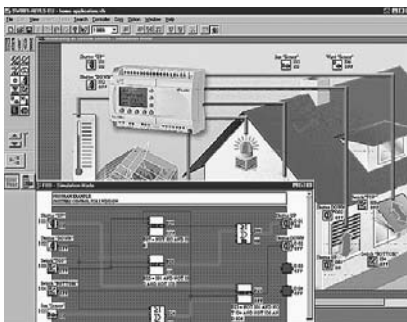

The original visual based function block programming software for logic controllers. Easy to use Windows based software that requires no prior experience or training by the user. Program elements are placed on screen, with inputs on the left and outputs on the right and the function blocks in the middle.

- Easy to use and easy to learn
- Point, click, drag and drop programming
- Program simulation - no controller needed
- Real time program monitor
- Process visualisation

Robots programming

RT ToolBox2



The RT ToolBox2 software helps you to program all MELFA robots and manage your projects. A intuitive user interface makes projects easy to understand and organise, even for beginners. RT ToolBox2 is also available with a simulator that enables you to simulate your robot program and calculate the expected work cycle times before you have built up your application.

- Function-based parameter management
- Range of recording and monitoring functions
- Program and monitor multiple robots in a network
- Includes both Position Repair and Maintenance Forecast functions
- Syntax highlighting and online Teach-In

Servo/Motion programming

MT Works2

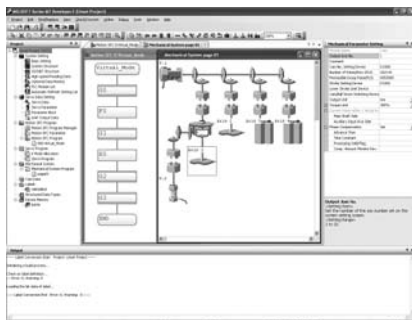

MT Works2 is an integral start-up software used to structure and configure a system for MELSEC System Q motion controller applications.

- The system settings and servo data can be set intuitively with graphical screens
- Various operating system software corresponding to the machine and control details is available with the motion controller. Providing a programming environment matching the application.
- Start-up and debugging time can be shortened by using system tests and program debugging.
- The system and program operation state can be checked with the monitor function and digital oscilloscope function allowing any problems to be resolved quickly.

MR Configurator2

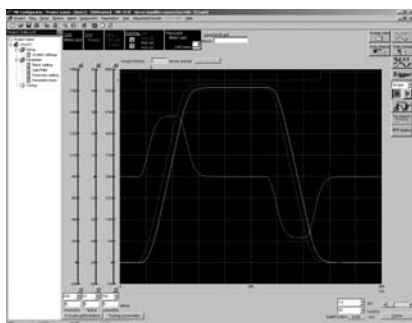

MR Configurator2 is a user-friendly software for easy setup, tuning and operation. Tuning, monitor display, diagnosis, reading/writing parameters, and test operations are easily performed on a personal computer. This start-up support tool achieves a stable machine system, optimum control, and short setup time.

- Graph display function allows the servo motor state to be easily monitored.
- Machine analyser function, gain search function and machine simulation function for high performance adjustments.
- Optimum Control, allows the response setting value to be set making use of the servo's "high level real-time automatic tuning".
- The servo system can be tested easily using a PC.

FX Configurator FP



FX Configurator FP is a special configurator tool for the FX3U PLC SSCNETIII positioning module. This software reduces programming and setup time for any level of positioning application.

Special applications

FR Configurator

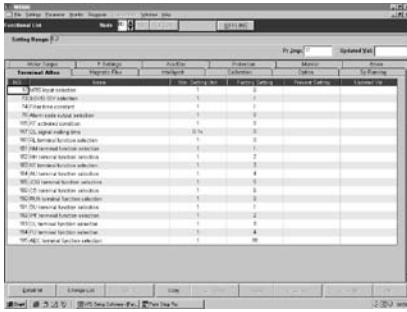

FR Configurator is a powerful frequency inverter configuration and management tool. It runs in Windows making it possible to manage your inverters with a standard PC. It allows the inverters to be monitored and the parameters to be configured, providing a user friendly environment to control single or multiple inverters.

- Machine analyser system, allows the resonant frequency of the machine to be tested as the motor is accelerated.
- Monitoring functions make maintenance easy
- Test Operation function and automatic tuning
- Diagnostics and help functions
- Trace Function, emulates an oscilloscope.
- Parameter setting and editing

PC Data Management

MX Sheet



The device data in the PLC can be monitored in real-time with Excel, and recipe data in Excel can be transferred to the PLC.

MX Sheet enables users to gather data from their PLC and analyse it using the familiar tools and functions of Excel. MX Sheet can analyse and display real-time data in tables, graphs and charts as it happens.

It also features a useful automatic report function, whereby data displayed on Excel automatically saves and prints at a specific time or condition triggered by the PLC.

MX OPC Server



The MX OPC Server is a Mitsubishi Electric I/O driver OPC Data Access (DA) and Alarm/Events (AE) server that provides the interface and communications protocol between a wide range of Mitsubishi Electric hardware and your process control software. Mitsubishi Electric drivers incorporate OLE Automation technology and OPC compliance to provide flexibility and ease-of-use.

Mitsubishi Electric's drivers incorporate OLE Automation technology and can therefore expose their features to scripting tools and other applications. Because the drivers are OLE Automation applications you can create and manipulate objects exposed in the I/O Server from another application. You can also create tools that access and manipulate driver objects.

MX Component

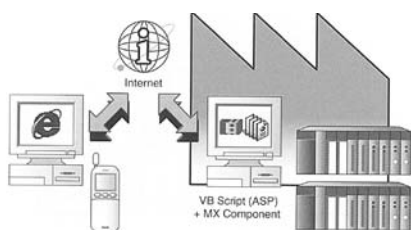

Just by accessing the Web Pages created with VBScript (ASP function) using Internet Explorer or mobile devices, the factory's PLC can be remotely monitored and operated.

MX Component provides users with powerful ActiveX controls that simplify the communication between a PC and PLC. Users do not have to design complex communication protocols and is ideal for implementing specific software applications requiring PLC connectivity.

MX Component supports a wide variety of powerful and standardised programming languages such as Visual C++, .NET, VBA and VB Script.

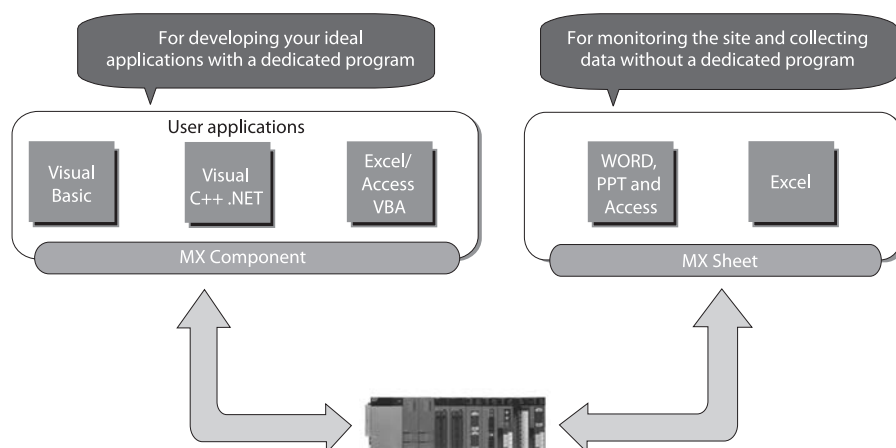

Life Cycle Engineering Software

MAPS – Mitsubishi Electric Adroit Process Suite



The Mitsubishi Electric Adroit Process Suite (MAPS) is a life-cycle software tool that offers value along the entire value chain. It addresses the shortcomings of most PLC SCADA integration tools in that it offers value to the engineering and integration phases. MAPS offers customers the ability to handle the normal extensions and maintenance of any automation solution.

This single integrated package takes users through all the phases of process design, engineering design, control system design, installation, commissioning, acceptance testing and ongoing maintenance; helping to maintain consistency and integrity within an automation system, improving quality and reducing costs.

- Pre-defined and user configurable PLC Function blocks and associated SCADA graphics based on S88/S95 standards to reduce engineering time and effort significantly
- The MAPS solution is a structured single point of configuration. Using the MAPS Enterprise Manager, allows for bulk engineering and reduced effort which enables rapid configuration of your engineering design, SCADA and PLC project and on-going life-cycle management of the automation solution.
- Cost reductions of between 30 % and 50 % can be achieved when using the wizard approach to projects inside MAPS, allowing the user to benefit from the reduced time spent on design and configuration.
- In MAPS reports can be created, covering I/O schedules, PLC and SCADA tag configuration. As these reports are generated from a database that is constantly updated, reports always show the current status of the configuration. That ensures that the project on handover reflects the as-built up to date configuration of the automation project.
- The MAPS solution offers customers the capability of on-going management of their PLC/SCADA projects and the plant's as-built electrical documentation. Whether tags are changed in the design, PLC, SCADA or the MAPS management environment, the project ensures that databases and documentation are synchronised.

Networks

From simple stand alone systems and basic AS-Interface networks to Ethernet based networks and even Global networks based on Remote Telemetry Technology, Mitsubishi Electric has the answers. Here is an overview of some of the networks Mitsubishi Electric provides:

Ethernet

The standard network for business operations is Ethernet. There are various options available, 10 Mb rate is the most common, but many new installations are operating at 100 Mb transfer rate. Ethernet could be termed an OPEN network owing to its absolute acceptance within the IT environment and the sheer number of providers of Ethernet based IT products. Ethernet can be used with various different protocols. The most popular protocol used is TCP/IP which most people use every single time they log on to the Internet.

CC-Link (Process Solution/Fieldbus)

CC-Link covers all Mitsubishi Electric automation products, from PLCs, motion controllers and CC-Link Safety to HMI control terminals and robots. Although CC-Link is an open network it is controlled by the CC-Link Partner Association (CLPA), which allows them to implement a strict control/testing regime of any product which connect onto CC-Link. This helps to guarantee and preserve the CC-Link network integrity.

Modbus/TCP

This protocol is widely accepted as a manufacturer neutral, defacto standard for automation. Modbus/TCP is widely supported by PLC manufactures, I/O vendors and by many other automation technology.

Profibus DP (Process Solution/Fieldbus)

Profibus offers users the option to mix devices on the network, ranging from simple remote I/O stations and inverter stations through to more complex HMIs, data logging devices and PLCs.

Profinet

Profinet is an open Industrial Ethernet standard for automation. It uses TCP/IP and IT standards, is capable of real time Ethernet and allows the integration of fieldbus systems.

DeviceNet (Process Solution/Fieldbus)

DeviceNet is an emerging Open vendor network. The DeviceNet network is based on the Controller Area Network (CAN) serial bus system. DeviceNet is a producer/consumer operation where peer-to-peer or master/slave configurations are possible.

CANopen

Cost effective network communications with fault-resistant network structure where components from different manufacturers can be integrated quickly and easily.

AS-Interface (Actuator - Sensor - interface)

This network is well supported by sensor manufacturers. AS-Interface can be used both with standard sensors and with special AS-Interface sensors. The dedicated AS-Interface sensors are typically more expensive than standard ones but do offer additional diagnostic functions and automatic configuration.

MELSECNET/H

This is Mitsubishi Electric's own high-performance network. MELSECNET/H can be configured as a coaxial bus or twisted pair bus system or with double ring topology. This offers high network availability, as cable breaks are automatically detected and the active communication channel is automatically re-routed around the suspected break. Another major feature of the MELSECNET/H network is the ability to operate a floating master system. This allows other PLC's on the network to take up the position of network master should a fault develop with the currently selected master.

SSCNETIII

Mitsubishi Electric's optical fibre based Servo System Controller Network (SSCNETIII) offers noise resistance communication for high-speed servo and motion applications.

Series	Ethernet	CC-Link	Modbus/TCP	Profibus	Profinet	DeviceNet	AS-Interface	MELSECNET/H	SSCNET	CANopen	Modbus/RTU
Modular PLC	●	●	●	●	●	●	●	●	●		●
Compact PLC	●	●		●		●			●	●	●
HMI	●	●	●	●				●			●
Inverter	●	●	●	●	●	●			●		●
Alpha							●				
Servo		●							●		
Breaker		●		●							●
Robot	●	●		●							

Typical Distributed Control Structure

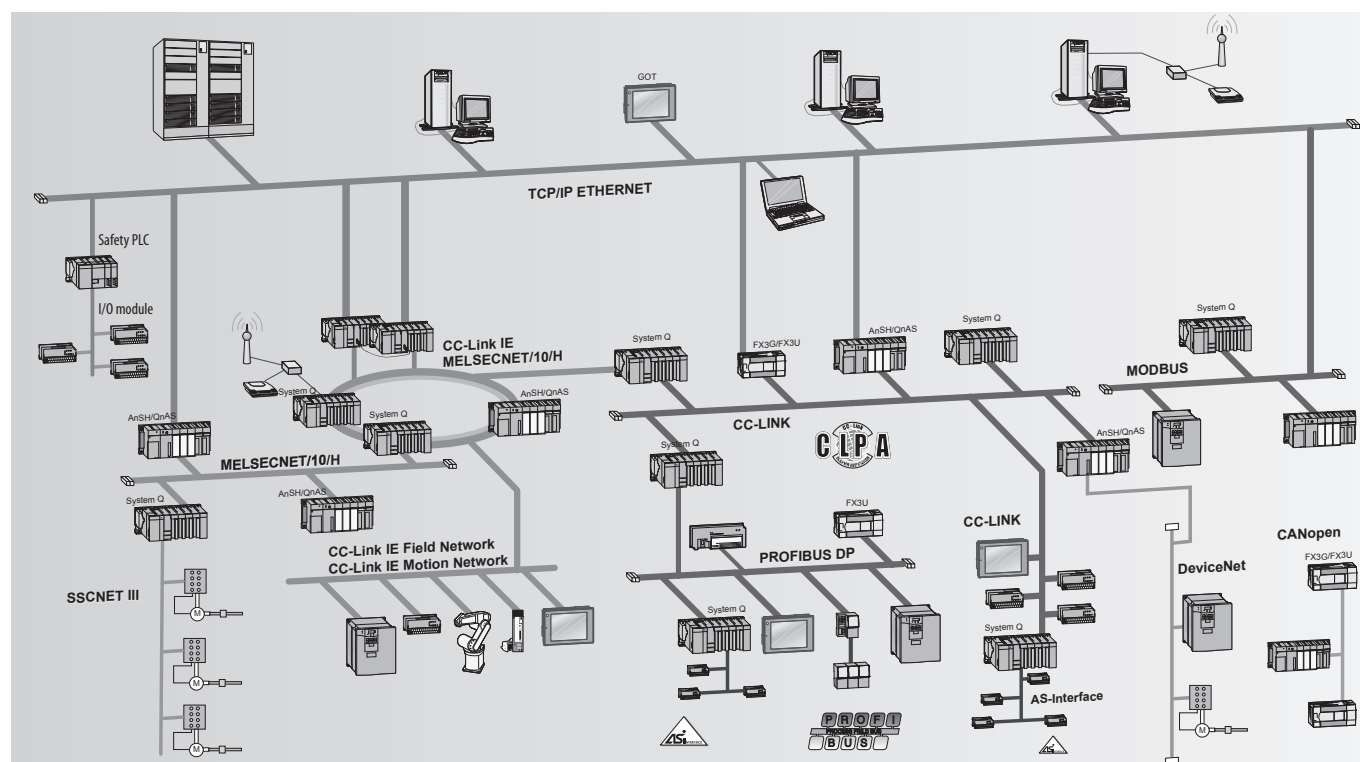

Ethernet

If you are looking for the widest possible set of connectable technologies, Ethernet is unrivalled. While being well established in the office and IT environments, its adoption into automation environments is both rapid and broad ranging.

Ethernet is a platform for a very wide range of data communications protocols. The combination of Ethernet and the extremely widespread TCP/IP protocol enables high-speed data communications between process supervision and the MELSEC PLC series. The MELSEC PLC compatible Ethernet modules also provide FTP server functionality, in addition to the normal TCP/IP communications services. This means that a personal computer running standard communications software can read from and write to the PLC CPU sequence program via the Internet.

There is also a growing demand for Ethernet to be used as a peer-to-peer network. We recognise this important customer requirement and

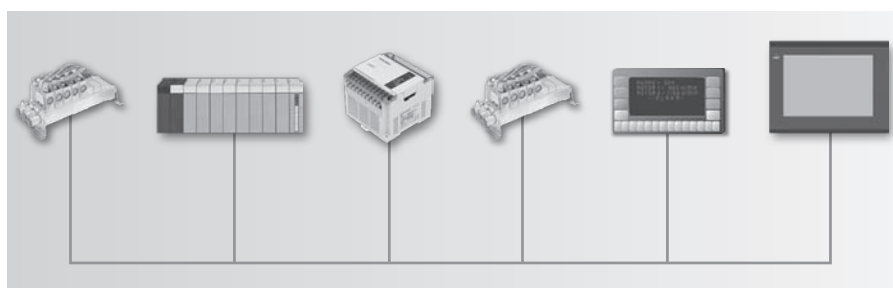

provide peer-to-peer communication with our Ethernet solutions.

- Up to 100 Mbps communication
- Monitor/program online *
- MELSEC System Q module mounts on the backplane, FX module adds onto the system

- Allows connection to PC, PLC and other third party device

- Preferred connection method for SCADA
- Modbus/TCP protocol

* Not supported by all Ethernet products

Model type	Series	Module	Description	Art. no.
Interface	MELSEC System Q	QJ71E71-100	Ethernet interface module, 100 Mbps, 100BASE-TX/10BASE-T	138327
		QJ71E71-B2	Ethernet interface module, 10BASE2	129614
		QJ71E71-B5	Ethernet interface module, 10BASE5	147287
		QJ71MT91	Modbus/TCP Master and Client 10BASE-T/100BASE-TX	155606
		NZ2EHG-T8	Compact-sized industrial switching HUB equipped with 8 ports capable of 1000BASE-T	259221
		NZ2EHF-T8	Compact-sized industrial switching HUB equipped with 8 ports capable of 100BASE-T	259222
	AnS	A1SJ71E71N3-T	Ethernet interface module, 10 Base-T	163755
		FX3U-ENET-ADP	Ethernet interface module, 10 Base-T	157447
	FX series	FX3U-ENET	Ethernet interface module, 100BASE-TX/10BASE-T	166086
		FX3U-ENET-P502	Ethernet modul, 100BASE-TX/10BASE-T, Modbus/TCP ready	225142
E series		IFC-ETTP	10-Base-T Twisted Pair Ethernet interface for E300/600/610/615/700/710/900/910 HMI's	104727
	IFC-ETCX	Coaxial 10-Base-T Ethernet interface for E300/600/610/615/700/710/900/910 HMI's	104726	
GOT series	A9GT-J71E71-T	10-Base-T Ethernet interface module for GOT HMI's	139395	

CC-Link, CC-Link IE, CC-Link IE Field and CC-Link Safety

If you need unparalleled ease of connection between Mitsubishi Electric products or you are looking for a single supplier for your control network needs, then CC-Link is the natural choice.

This open fieldbus and control network provides fast data communications with different devices. As with all manufacturer specific networks, CC-Link is quickly implemented and is guaranteed to work. CC-Link is also an open network and therefore allows many third-party products now appearing on the market with CC-Link connectivity. Companies such as SMC, Festo, Siemens,

Sunx, Yokogawa, Kawasaki Heavy Industries, Izumi-DATALogic Co., Wago and Keyence have developed products for CC-Link. The CC-Link network has the capability to have a standby master which can also be used as a remote station.

The new CC-Link IE open standard offers maximum performance at maximum availability. CC-Link IE Control serves firstly as a network for the control level and furthermore implements the manufacturing level, the motion level and the safety level. In future, the network structure will be uniform at all levels.

CC-Link IE Field is a high-speed and high-capacity network able to cope with a mixture of device control data and management data. In addition, distributed control, I/O control, motion control and safety functions can all be seamlessly set.

Other interesting information on the CC-Link IE is provided in a separate brochure which is also available for download.

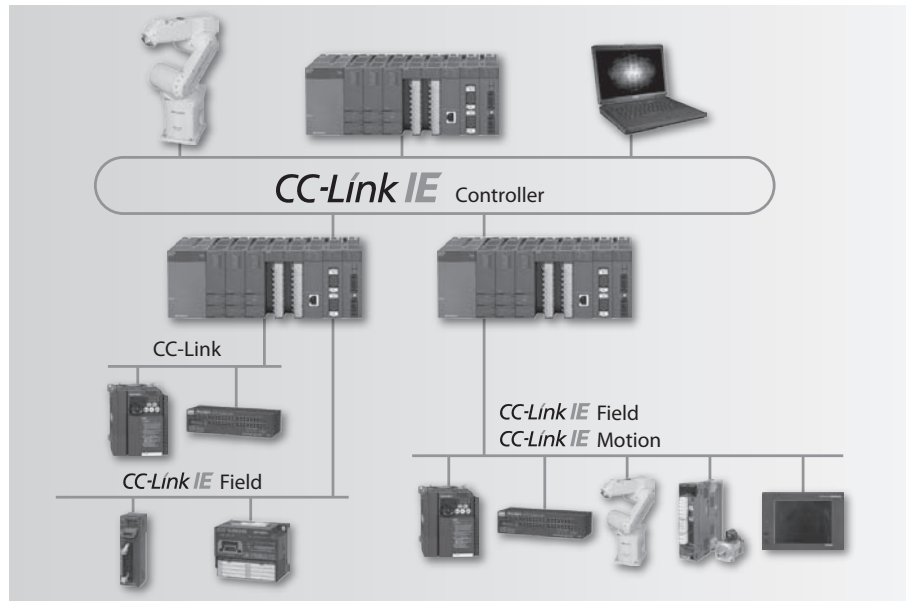

- Up to 13.2 km network distance
- Monitor/program online with MELSEC System Q
- Max. transfer rate 10 MBaud with max. 64 bus stations
- Easy connection for Mitsubishi Electric devices
- No programming needed for set-up with MELSEC System Q
- Has built-in redundancy functions and excellent error tolerance
- CC-Link Safety, TÜV-certified safety network

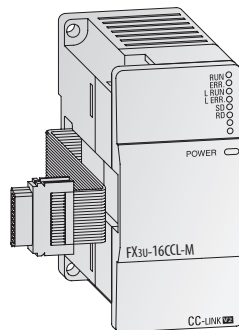

Master module
FX3U-16CCL-M

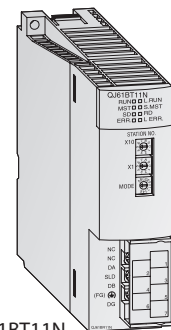

Master/local
module QJ61BT11N

Standard CC-Link modules

PLC	Master Modules	Description	Art. no.
MELSEC System Q	QJ61BT11N	CC-Link master/local module	154748
	QS0J61BT12	Master modules for CC-Link Safety	203209
FX series	FX3U-16CCL-M	CC-Link master	248224
L series	L26CPU-BT	CPU with integrated CC-Link master/local module	238056
	LJ61BT11	CC-Link master/local module	238099
PCI Express	Q81BD-J61BT11	Master module/local module for PCI Express bus	221859
PCI	Q80BD-J61BT11N	Master /local module for PCI/F PC master	200758
Slave Modules			
MELSEC System Q	QJ61BT11N	CC-Link master/local module	154748
FX-Family	FX2N-32CCL	CC-Link local module	102961
	FX3U-64CCL	Local module for CC-Link on FX3	217915
Frequency inverters	FR-A7NC	CC-Link interface for frequency inverters of the FR-A700/FR-F700 series	156778
	FR-A7NC-Ekit-SC-E	CC-Link interface for frequency inverters of the FR-E700 SC series	239644
HMI	GT15-75J61BT13-Z	CC-Link interface for GOT 1000	166310
Breakers	BIF-CC-W	CC-Link interface for SUPER AE air circuit breakers	168571
Servo amplifiers	MR-J3-T(4) series	MR-J3 servo amplifier with CC-Link interface	page 121
Robots	2A-HR 575H E	CC-Link interface for robots for the CR-2, CR-2A and CR-1 controller	129808

CC-Link IE modules

PLC	Master /Slave Modules	Description	Art. no.
MELSEC System Q	QJ71GF11-T2	CC-Link IE field master/slave modul, 1Gbps, Cat5e	236484
	Q50J71GF11-T2	CC-Link IE field master/local module	245177
	QJ71GP21-SX	1 Gbps, master/slave module for FO GI	208815
	QJ71GP21S-SX	1 Gbps, master/slave module for FO GI with external voltage supply	208816
	Q80BD-J71GP21-SX	1 Gbps, PCI PC card, master/slave for FO GI	208817
	Q80BD-J71GP21S-SX	1 Gbps, PCI PC card, master/slave for FO GI with external voltage supply	208818
	Q81BD-J71GF11-T2	PCI PC card, master/local module	253008
	NZ2GF-ETB	CC-Link IE field network Ethernet adapter	253007
	LJ71GF11-T2	CC-Link IE field master/local module	246346
	LJ72GF15-T2	CC-Link IE field head module	238100

CC-Link Cable

This cable is designed for connecting together CC-Link network devices to create peer-to-peer systems (e.g. Mitsubishi Electric MELSEC System Q), master/slave systems (e.g. Mitsubishi Electric MELSEC System Q and Mitsubishi Electric CC-Link Remote I/O) and provide connection with any CC-Link compatible product. It has been tested and certified by CLPA (CC-Link Partner Association) as a CC-Link compliant partner product.

ELECTRICAL CHARACTERISTICS

Max. operating voltage	300 V RMS
Nom. capacitance between conductors @1 kHz	60 pF/m
Nom. impedance @ 1 MHz	110 Ω
Nom. conductor DC resistance @ 20°C	36 Ω/1000 m
Nom. attenuation @ 1 MHz	1.6 dB/100 m
Nom. attenuation @ 5 MHz	3.51 dB/100 m
Insulation resistance	≥10,000 MΩ/km

Web Server

This unit allows direct access from Internet/ Intranet to MELSEC System Q. With ample built-in memory, flexible communications and compact design, it is the perfect tool to give you visualisation of MELSEC System Q PLC control processes. MELSEC System Q Web Server supports open standards such as HTML, JAVA, HTTP, FTP, etc. to give the easiest and most cost effective method of monitoring a single or networked system.

The MELSEC System Q Web Server is easy to set-up because everything you need to get started is built into the unit. Configuration is carried out via embedded web pages that guide the user through the set-up process. Settings like IP Address, Tag and Component Registration, Account Management and Data Logging Options are all easily set with a Web Browser. Furthermore, there is storage space for user generated web pages.

Finally, as you would expect from Mitsubishi Electric, this unit is designed for harsh environments and has the same robust design as the rest of the MELSEC System Q.

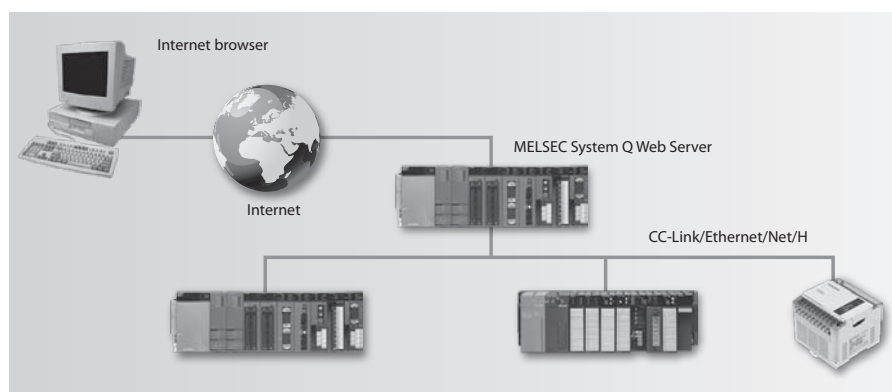

- 5 Mbyte of built in memory, option to expand up to 512 Mbyte (CompactFlash)
- 100 BaseTX Ethernet port
- Serial RS232 port
- Pre-loaded HTML/JAVA samples to get you started
- Connects via Q-bus and down CC-Link, Ethernet, MELSECNET/H or Serial communication unit.

Model type	Series	Module	Description	Art. no.
Web Server	MELSEC System Q	QJ71WS96	Q Web Server module	147115

Profibus DP

Profibus is one of the most widely used automation networks in Europe. It provides a wide possible range of compatible devices while delivering fast and robust communication.

Profibus offers users the option to mix devices from different companies. It is an open network ranging from simple I/O stations through to complex PLCs. The network allows extremely fast data exchange with a wide variety of slave devices. The GX Configurator DP software and the Profibus master modules combine to give a user-friendly plug and play technology. The configuration software is self-explanatory, using a graphical method to set up the network. You simply select the slave unit, assign the station number and specify where in the PLC the information is stored. As this is an open network, Mitsubishi Electric Profibus units can also be connected to master and slave devices from other manufacturers.

- Widely supported by many manufacturers
- Up to 12 Mbps transmission speed
- Easy set-up with GX Configurator DP
- Full range of Mitsubishi Electric Profibus products
- Master and slave available with MELSEC System Q and FX Series

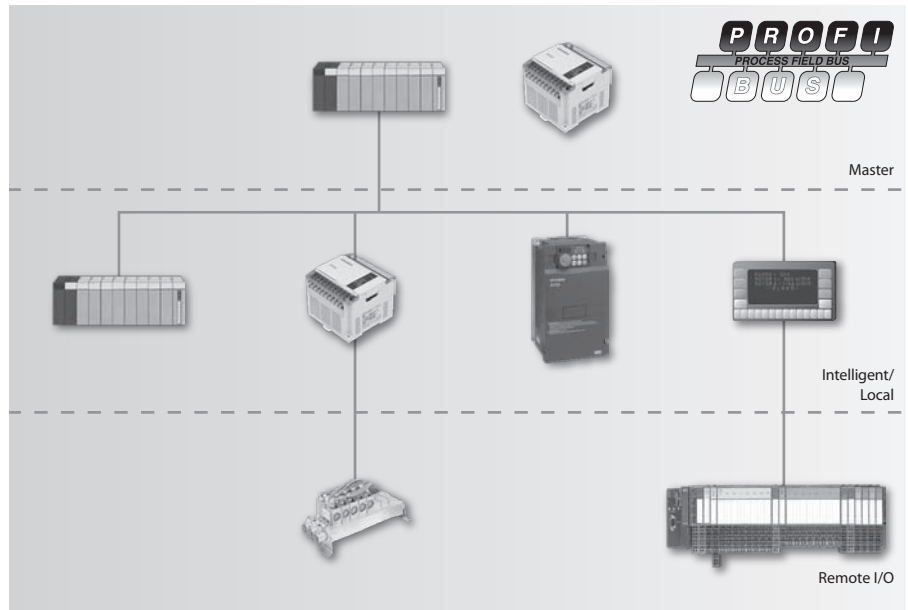

MASTER

Series	Module	Description	Art. no.
MELSEC System Q	QJ71PB92V	Profibus DP interface master module (DP V1/V2)	165374
FX series	FX3U-64DP-M	Profibus DP master module for FX3U PLCs	166085

INTELLIGENT SLAVE

Series	Module	Description	Art. no.
MELSEC System Q	QJ71PB93D	Profibus slave	143545
FX series	FX0N-32NT-DP	Profibus DP slave module for FX1N/FX2N and FX3U PLC's	62125
	FX3U-32DP	Profibus DP slave module for FX3U PLCs	194214
Inverter	FR-A7NP	Profibus interface for frequency inverters of the FR-A700 and FR-F700 series	158524
	FR-A7NP-Ekit-SC-E	Profibus interface for frequency inverters of the FR-E700 SC series	239646
	FR-A7NP-Ekit-SC-E-01		239647
HMI	IFC-PBDP	Profibus DP slave interface for E300/600/610/615/700/710/900/910 HMI's	76676
Breaker	BIF-PR-W	Profibus interface for SUPER AE air circuit breakers	168572

SLAVE I/O

Series	Module	Description	Art. no.
All PLC types	ST series/STlite series	Modular input/output system for connection to Profibus DP	refer to page 20 and following

I/O BRIDGE MODULE

Series	Module	Description	Art. no.
FX series	FX2N-32DP-IF	Profibus remote I/O using FX2N I/O and special function modules; 240 V AC power supply	145401
	FX2N-32DP-IF-D	Profibus remote I/O using FX2N I/O and special function modules; 24 V DC power supply	142763

Profinet

Open industrial Ethernet standard for automation. Profinet uses TCP/IP and IT standards, is capable of real-time Ethernet and allows the integration of field bus systems.

Series	Module	Description	Art. no.
MELSEC System Q	ME1PN1FW-CCPU	Profinet master module	252935

DeviceNet

DeviceNet is another widely accepted open network type with a large variety of third party products. This network type is particularly popular in North America.

DeviceNet is based on a producer/consumer operation where peer-to-peer or master/slave configurations are possible. DeviceNet is based on CAN (Controller Area Network) serial bus system. DeviceNet is a cost-effective solution for network integration of low level terminal equipment.

- Widely supported by many manufacturers
- Up to 500 kbps transmission speed
- Easy set-up with GX Configurator DN for MELSEC System Q
- Wide range of Mitsubishi Electric DeviceNet products
- Master and slave available with MELSEC System Q and AnS Series

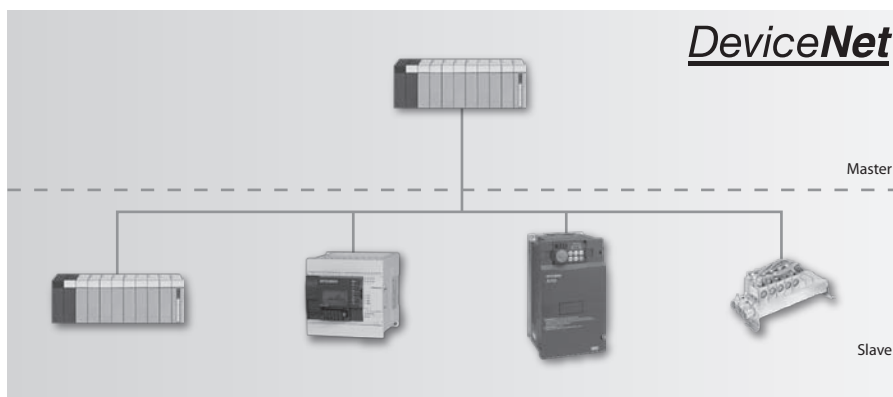

Model type	Series	Module	Description	Art. no.
Master	MELSEC System Q	QJ71DN91	DeviceNet interface master/slave module	136390
	AnS/QnAS series	A1SJ71DN91	DeviceNet master/slave module, for AnS and QnAS PLC's	124373
Intelligent Slave	FX series	FX2N-64DNET	DeviceNet interface (slave)	131708
	Inverter	FR-A7ND	DeviceNet interface for frequency inverters of the FR-A700 and FR-F700 series	158525
		FR-A7ND-Ekit-SC-E	DeviceNet interface for frequency inverters of the FR-E700 SC series	239648

AS-Interface

The Actuator Sensor Interface (AS-Interface) is the international standard for the lowest field bus level. The network suits versatile demands, as it's very flexible and easy to install. It is usually used to control sensors, actuators, I/O units and gateways. The AS-Interface network has its own distinctive yellow cable which acts as both a communication line and a power supply for connecting devices. By using special coupling bridges, any slave station on the network can be moved and placed at a new location without having to completely rewire or rebuild the network.

- MELSEC System Q and AnS series supports 2 networks/62 stations with a single module
- Easy to configure and swap modules
- Self healing cable needs no tools for installation or system changes

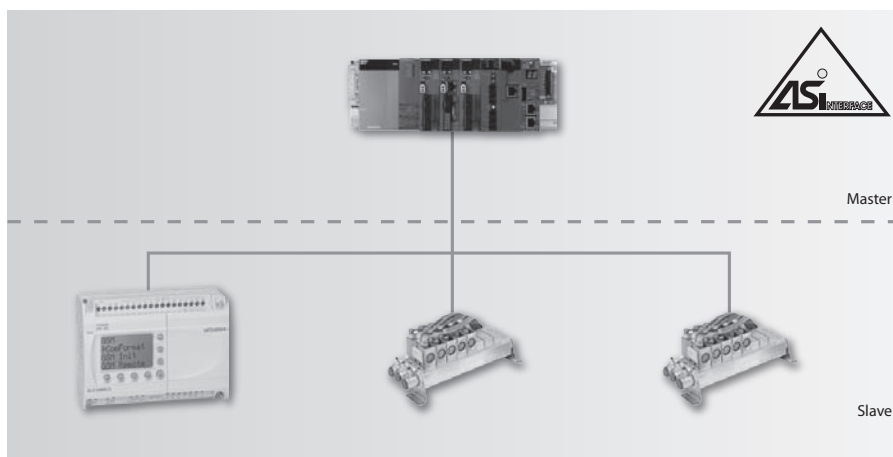

Model type	Series	Module	Description	Art. no.
Master	MELSEC System Q	QJ71AS92	AS-Interface module, version 2.11, dual network master	143531
	AnS series	A1SJ71AS92	AS-Interface master module for AnS (Double network master)	129936
Intelligent Slave	Alpha	AL2-ASI-BD	AS-Interface board for use with AL2-14M or AL2-24Ms	142525

MELSECNET/H

For the systems that demand uncompromising reliability and high speed performance, only a dedicated network can deliver. MELSECNET/H and its predecessor MELSECNET/10 use high speed, redundant functionality to give deterministic delivery of large data volumes.

This is Mitsubishi Electric's own dedicated network. MELSECNET has a dual cable configuration. This offers high network availability, as cable breaks are automatically detected and the active communication channel is automatically re-routed around the suspected break. The MELSECNET network also allows a floating master. This allows other PLCs on the network to take up the position of network master should a fault develop with the currently selected master. The MELSECNET allows very large network coverage of up to 30 km.

- Up to 64 stations per network
- Up to 239 networks (MELSEC System Q) can be joined together
- Floating master give excellent redundancy if master station fails
- Fibre optic (GI or SI cable) and 50 q coaxial connection
- Used for peer-to-peer or remote I/O control
- Easy set-up, no programming needed
- Strong diagnostics built into the network interface, PLC CPU and programming software
- Up to 16 k words of data per network
- Maximum transmission speed 50 Mbps (SI fibre only, full duplex communication)
- Maximum transmission distance for single network, 30 km fibre loop or 500 m coaxial

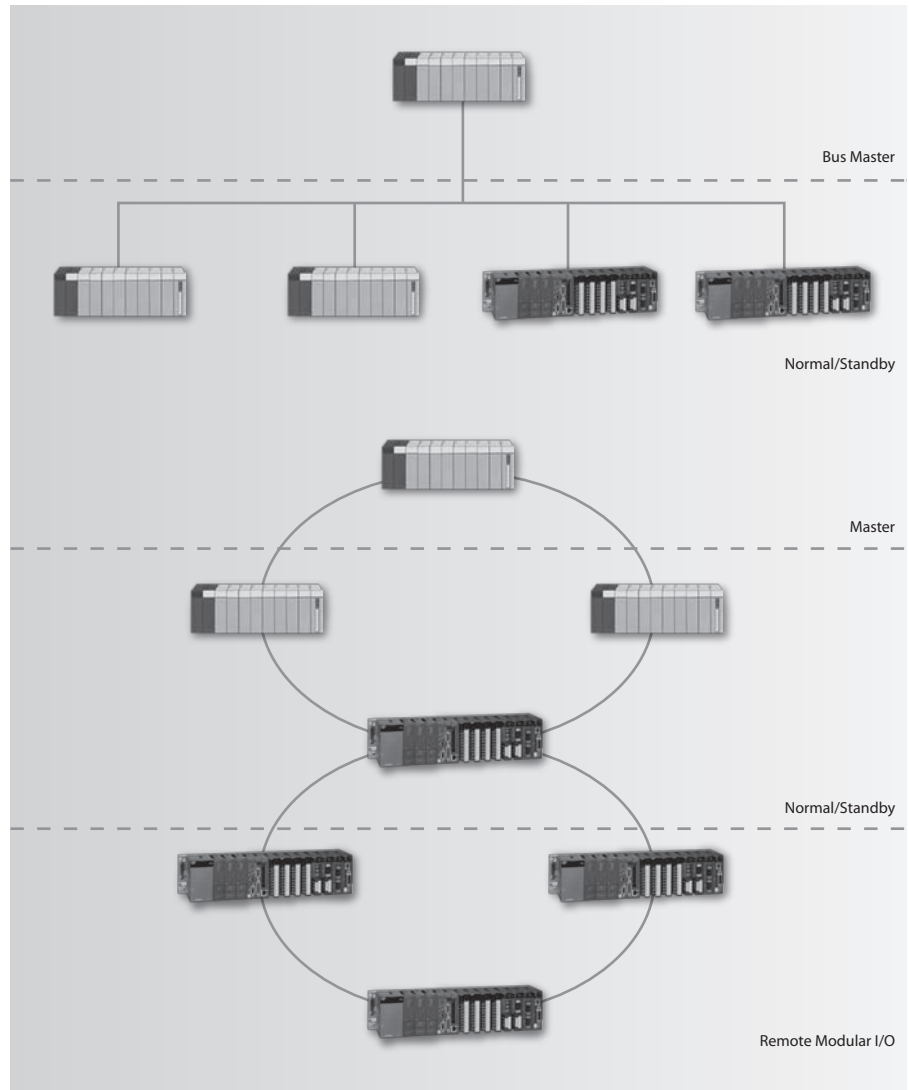

Model type	Series	Module	Description	Art. no.
Master/local	MELSEC System Q	QJ71BR11	MELSECNET/H master/local, coaxial cable	127592
		QJ71LP21GE	MELSECNET/H master/local, GI 62.5/125 fibre optic cable	138959
		QJ71LP21-25	MELSECNET/H master/local, SI fibre optic cable	136391
		QJ71NT11B	Master/local station for MELSECNET/H (twisted pair)	221861
	AnS	A1SJ71LP21GE	MELSECNET/10 master/local, GI 62.5/125 fibre optic cable	53457
		A1SJ71LP21	MELSECNET/10 master/local, SI fibre optic cable	47868
		A1SJ71BR11	MELSECNET/10 master/local, coaxial cable	47869
		A1SJ71QBR11	Q2AS MELSECNET/10 master/local, coaxial cable	66540
Slave I/O	MELSEC System Q	QJ72LP25-25	MELSECNET/H remote I/O controller, SI fibre optic cable	136392
		QJ72BR15	MELSECNET/H remote I/O controller, coaxial cable	136393
	QnAS	A1SJ72QBR15	QnAS MELSECNET/10 remote I/O controller, coaxial cable	68450
		A1SJ72QLP25	QnAS MELSECNET/10 remote I/O controller, SI fibre-optic cable	68449

SSCNETIII

Mitsubishi Electric's SSCNET (Servo System Controller Network) is a dedicated motion controller network ensuring maximum control and flexibility for motion systems under all conditions.

The motion controllers and servo amplifiers can be linked via the SSCNET network.

SSCNETIII achieves speeds of up to 50 Mbps ensuring both high speed and high accuracy.

During operation, all parameters and operational data are available back at the main controller due to the communication provided by the SSCNET system bus. Servo amplifier settings can be changed directly from the controller.

- "Plug and Play" for ease of connectivity, instant communication and reduced wiring faults.
- Greater flexibility for system integration.
- High speed networking with fast cycle time.
- Direct bus operation with fast access
- Fibre-optic connection cables for noise immunity.

CANopen

CANopen is an “open” implementation of the Controller Area Network (CAN), which is defined in the EN50325-4 standard. It was developed by members of the CAN in Automation international users and manufacturers group. The CANopen application layer defines a range of communications services and protocols (e.g. process and service data) and a network management system.

CANopen networks are used for connecting sensors, actuators and controllers in industrial control systems, medical equipment, maritime electronics, railways, trams and commercial vehicles.

A CANopen bus system has a linear structure to which up to 127 bus stations can be connected. Multiple master stations can be connected to a single bus. The ends of the linear bus are terminated with resistors. Total network length can be up to 40 m at a data transfer rate of 1 Mbps. Lowering the data rate makes it possible to increase the length of the bus. For example, a transfer rate of 125 kbps allows a bus length of 500 m. This can be increased to a maximum of 5,000 m with the help of repeaters (at 10 kbps).

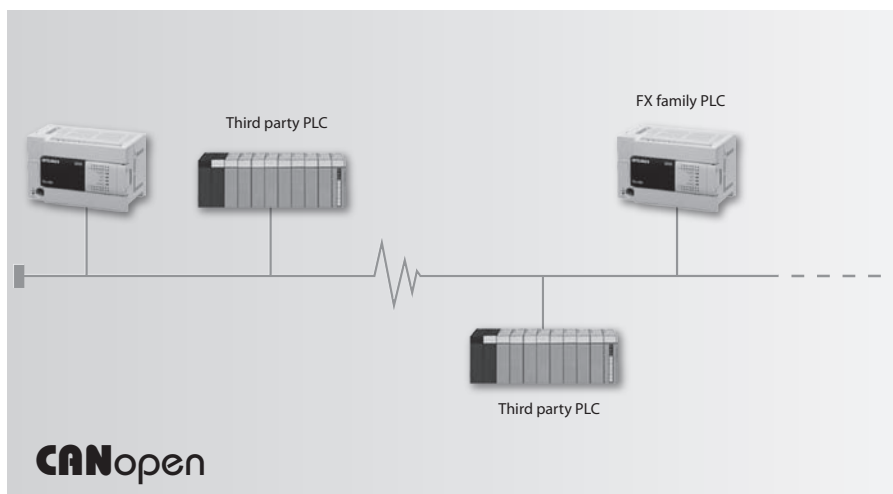

Model type	Series	Module	Description	Art. no.
Local	FX series	FX3U-CAN	Communications module for CANopen	252845

Modbus

The Modbus protocol is a messaging structure which is used to establish master-slave/client-server communication between intelligent devices. It is a de facto standard, truly open and a widely used network protocol in the industrial manufacturing environment.

Modbus allows communication between many devices connected to the same network, for example a system that measures temperature and humidity and communicates the results to a PC. Modbus is often used to connect a supervisory computer with a remote terminal unit (RTU) in supervisory control and data acquisition systems (SCADA). Versions of the Modbus protocol exist for serial port and Ethernet.

Modbus RTU is a compact, binary representation of the data.

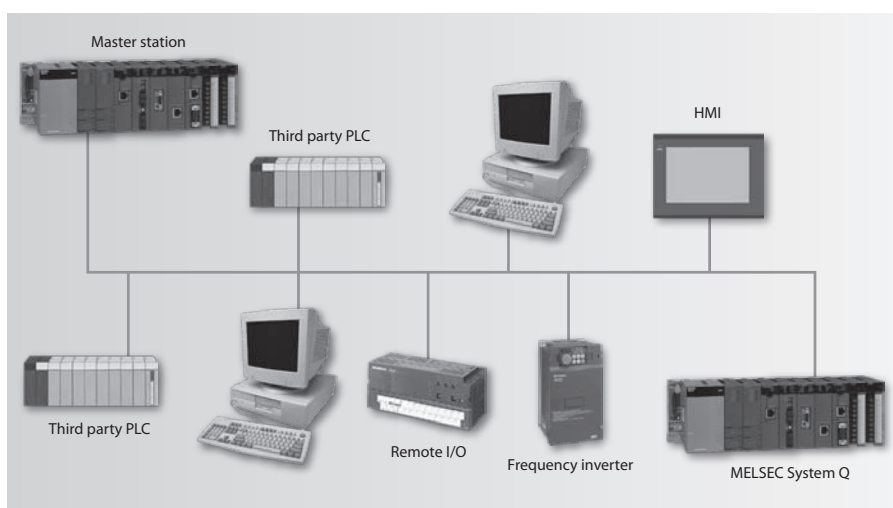

Model type	Series	Module	Description	Art. no.
Master/Slave	MELSEC System Q	QJ71MB91	Serial Modbus interface master/slave module	167757
		QJ71MT91	Modbus/TCP interface master/slave module for Ethernet	155603
	FX series	FX3U-232ADP-MB	Serial Modbus RS232C interface master/slave module	165276
		FX3U-485ADP-MB	Serial Modbus RS485 interface master/slave module	165277
		FX3U-ENET-P502	Ethernet modul, 100BASETX/10BASE-T, Modbus/TCP ready	225142
Slave	AnS series	A1SJ71UC24-R2-S2	Modbus slave interface module	54355
		A1SJ71UC24-R4-S2	Modbus slave interface module with RTU protocol	54354
	Breaker	BIF-MD-W	Modbus interface for SUPER AE air circuit breakers	168573

CC-Link/CC-Link IE Field remote modules

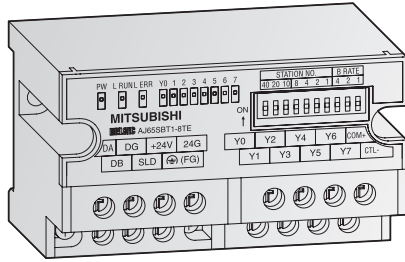
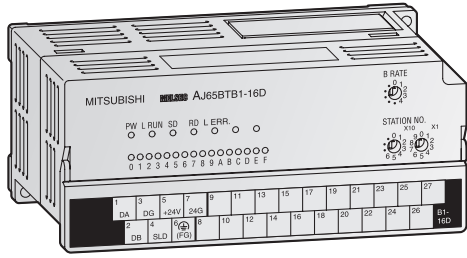

These remote modules are intended to be installed near the control target. The advantages are reduced cabling and the capability of acquiring data and operation results of individual machine modules autonomously.

For wet environments six types of low profile waterproof remote I/O modules with IP67 protection are available featuring Input, Output and Combination modules.

- Up to 64 I/O modules with a maximum of 32 inputs or 32 outputs each can be connected.
- All modules have a very compact design which is tough and highly shock-resistant.

- Status indicator LEDs for the inputs
- Standard electrical isolation between process and control via optocouplers
- Mounting with DIN rail adapters or screws
- Modules can be mounted in horizontal arrangement or in one of 4 orientations on a flat surface.
- Ready for use with all CC-Link master modules.

3 Remote I/O Modules

Product Range	Module	Type	No. of input	No. of output	Description	Art. no.	
Digital in	AJ65BTB1-16D	Remote module	16	—	DC input (+COM/-COM)	75447	
	AJ65BTB2-16D		16	—	DC input with 8 potential terminals (+COM/-COM)	75450	
	AJ65SBTB1-8D	8	—	DC input (+COM/-COM)	104422		
	AJ65SBTB1-16D	16	—	DC input (+COM/-COM)	136026		
	AJ65SBTB3-16D	Compact remote module	16	—	DC input (+COM/-COM), 3-wire sensors	151186	
	AJ65SBTB1-16D1		16	—	Fast DC input (+COM/-COM)	140144	
	AJ65SBTB1-32D1		32	—	Fast DC input (+COM/-COM)	140145	
	AJ65SBTB1-32D	32	—	DC input (+COM/-COM)	136025		
	AJ65FBTA4-16D	Waterproof remote module	16	—	Protection IP67, DC input (sink type)	137587	
	AJ65FBTA4-16DE		16	—	Protection IP67, DC input (source type)	137588	
Digital out	AJ65BTB1-16T	Remote module	—	16	Transistor output, (sink type), 0.5 A	75449	
	AJ65BTB2-16R		—	16	Relay output, 2 A	75453	
	AJ65SBTB1-8TE	Compact remote module	—	8	Transistor output (source type), short circuit proof, 0.1 A	129574	
	AJ65SBTB2-8T1		—	8	Transistor output (sink type), 0.5 A	144062	
	AJ65SBTB1-16TE		—	16	Transistor output (source type), 0.5 A	129575	
	AJ65SBTB1-32T	—	32	Transistor output (sink type), 0.5 A	138957		
	AJ65SBTB2N-8R	Compact remote module	—	8	Relay output, 2 A	140148	
	AJ65SBTB2N-16R		—	16	Relay output, 2 A	140149	
	AJ65SBTB1-16T1	Waterproof remote module	—	16	Transistor output (sink type), 0.5A	163966	
	AJ65SBTB1B-16TE1		—	16	Transistor output (source type), 0.1 A	204679	
	AJ65SBTB1-32TE1		—	32	Transistor output (source type), 0.1 A	204680	
	AJ65SBTB2N-16S		—	16	Triac output, 0.6 A	159954	
	AJ65FBTA2-16T		—	16	Protection IP67, DC output (sink type), 0.5 A	150380	
	AJ65FBTA2-16TE		—	16	Protection IP67, DC output (source type), 1 A	150381	
Combine	AJ65BTB1-16DT		Remote module	8	8	DC input (sink type), transistor output (sink type)	75448
	AJ65BTB2-16DT			8	8	DC input with 16 potential terminals (sink type), transistor output (sink type)	75452
	AJ65BTB2-16DR	8		8	DC input (source type), relay output	75451	
	AJ65FBTA42-16DT	Waterproof remote module	8	8	Protection IP67, DC output (sink type), DC input (sink type)	137589	
	AJ65FBTA42-16DTE		8	8	Protection IP67, DC output (source type), DC input (source type)	137590	
	AJ65SBTB1-32DT1		16	16	DC input (sink type), DC output (sink type), short circuit proof	166822	
AJ65SBTB1-32DTE1	16	16	DC input (source type), DC output (source type)	204681			
Analog in	AJ65BT-64AD	Remote module	4	—	4-channel input, -10—+10 V, -20—+20 mA	75444	
	AJ65BT-64RD3		4	—	4-channel input, for 3-wire-type Pt100 temperature sensors	88026	
	AJ65BT-64RD4		4	—	4-channel input, for 4-wire-type Pt100 temperature sensors	88027	
	AJ65BT-68TD	8	—	8-channel thermocouple input	88025		
	AJ65SBT-64AD	Compact remote module	4	—	4-channel input, -10—+10 V, 0 A—+20 mA	140146	
	AJ65SBT2B-64RD3		4	—	4-channel input, for Pt100 with three-wire technology	221862	
Analog out	AJ65BT-64DAV	Remote module	—	4	4-channel voltage output, -10—+10 V	75446	
	AJ65BT-64DAI		—	4	4-channel current output, 4—20 mA	75445	
	AJ65SBT-62DA	Compact remote module	—	2	2-channel voltage output, -10—+10 V, 0 A—20 mA	140147	
	AJ65SBT2B-64DA		—	4	4-channel voltage output, -10—+10 V, 0 A—20 mA	221863	
Repeater	AJ65SBT-RPT	Compact repeater	—	—	Repeater allowing 'T' branching and network extension	130353	

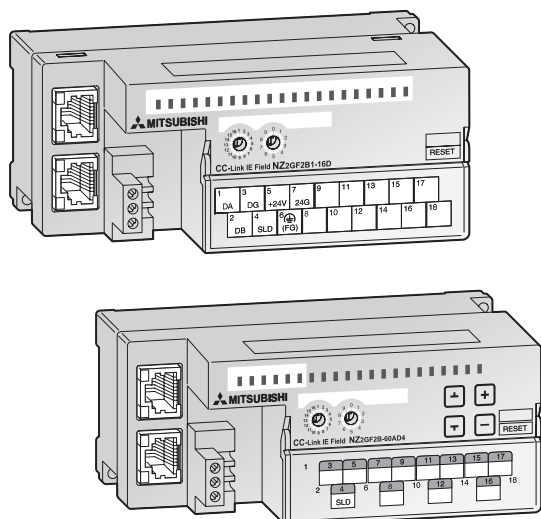

High-speed counter

The high-speed counter modules acquire signals at frequencies beyond the range of normal digital input modules. Positioning tasks or frequency measurements for example can be performed.

Open control loop positioning

Locating the positioning unit near the servo/mechanical system not only reduces cable costs but also eliminates problems arising from noise and cable losses.

Data exchange with peripherals

These modules allow communication with peripheral devices through a standard RS232C interface. The peripherals are connected point to point (1:1).

Product range	Module	Type	Description	Art. no.
Counter	AJ65BT-D62		2 high-speed counter inputs, 5–24V DC, up to 200 kHz	88028
	AJ65BT-D62D	Remote module	2 high-speed counter inputs, EIA standard RS422 connection, up to 400 kHz (low current consumption)	88029
	AJ65BT-D62D-S1		2 high-speed counter inputs, EIA standard RS422 connection, up to 400 kHz	88030
Interface	AJ65BT-R2N	Remote module	Serial interface, RS232C (D-Sub, 9 pole), 1 channel	216545
Positioning	AJ65BT-D75P2-S3	Remote module	2 axes positioning module, pulse output, linear and circular interpolation	88002
I/O modules	NZ2GF2B1-16D	CC-Link IE Field Network remote I/O module	16 points input, 24 V DC (positive/negative common shared) 1-wire, terminal block type, response time 0–70 ms	260472
	NZ2GF2B1-16T		16 points output, 12 to 24 V DC, 0.5 A/point, 4 A/common, transistor output (sink type) 1-wire, terminal block type	260473
	NZ2GF2B1-16TE		16 points output, 12 to 24 V DC, 0.5 A/point, 4 A/common, transistor output (source type) 1-wire, terminal block type	260474
	NZ2EX2B1-16D	CC-Link IE Field Network extension I/O module	16 points input, 24 V DC (positive/negative common shared) 1-wire, terminal block type, response time 0–70ms	260507
	NZ2EX2B1-16T		16 points output, 12 to 24 V DC, 0.5 A/point, 4 A/common, transistor output (sink type) 1-wire, terminal block type	260508
	NZ2EX2B1-16TE		16 points output, 12 to 24 V DC, 0.5 A/point, 4 A/common, transistor output (source type) 1-wire, terminal block type	260509
		NZ2GFCF-D62PD2	CC-Link IE Field Network remote I/O module	2 high-speed counter inputs, 5/24 V DC/Differential inputs, up to 8 MHz
	NZ2GF-CCB	CC-Link IE Field to CC-Link bridge module	Allows the connection of a CC-Link network to a CC-Link IE network.	266160
Analog modules	NZ2GF2B-60AD4	CC-Link IE Field Network analog-digital converter module	4 channels voltage/current analog-digital converter module (analog input type)	260505
	NZ2GF2B-60DA4	CC-Link IE Field Network digital-analog converter module	4 channels voltage/current digital-analog converter module (analog output type)	260506

See also CC-Link Safety Remote I/O Modules, page 162
See also CC-Link Safety Relays, page 163

The CC-Link Partner Association set-up a European headquarters at the beginning of January 2001 at Mitsubishi Electric's UK office. The role of the organisation is to provide information, education, and the promotion of CC-Link technology and CLPA partner products throughout Europe. One of the primary responsibilities of the organisation is to provide technical support to CLPA partners who plan to incorporate CC-Link compatibility in their products.

„Our target is to significantly increase the use of CC-Link, and to promote the CC-Link compatible products manufactured by CLPA partners. Promotional activities include educational seminars, exhibiting at trade shows, trade press coverage, mailings and web-based listings. For more information please contact us.“

John Browett, CLPA Europe

- Over 150 partner manufacturers of CC-Link products
- Over 700 CC-Link compatible products, including PLCs, servo drives, temperature controllers etc.
- Over 700 members, with a new partner manufacturer joining each month.



CC-LINK PARTNER ASSOCIATION EUROPE

Postbox 10 12 17
D-40832 Ratingen
Phone: +49 (0) 2102/486 1750
Fax: +49 (0) 2102/486 1751
e-mail: partners@clpa-europe.com
www.clpa-europe.com

Regional offices in UK,
Poland and Ukraine
for more information see
the website.

The MELSEC STlite series scalable I/O solutions for CC-Link, Profibus and Ethernet

Approved for a very wide range of applications, the STlite series features excellent module granularity and fieldbus-agnostic design, making it ideally suited for the requirements of today's distributed fieldbus systems. The devices are optimised for efficient processlevel communication, with scalable performance and high integration density.

- The range of potential applications is virtually unlimited.
- Reduces hardware and system overheads to a minimum.
- Simplifies handling and maximises efficiency.

The uncompromisingly modular architecture of the system also extends to its support for a wide range of fieldbus systems. You can install different head stations for different protocols, depending on the needs of your applications.

Optimised for real-life requirements

- Module granularity:
- 2, 4 or 8 channels in a single I/O module

Fieldbus-agnostic:

- Head stations available for the leading fieldbus protocols CC-Link, Profibus DP and Ethernet

Safe investment:

- Fieldbus node design enables easy switching to new bus standards without changing the bus modules.

Clear labelling:

- Colour-coded group identification plate brackets and terminal tags

Versatile:

- Configuration options for digital/analog inputs/outputs and special functions with different voltages, powers and signals on a single fieldbus node.

Reliable:

- Approvals for industrial and marine automation applications ensure a wide range of deployment options – even in heavy-duty environments.
- Automatic contacting for power and data contacts
- Pluggable connections with bus plug connector
- CAGE CLAMP® spring terminals for input/output point connections

Product range

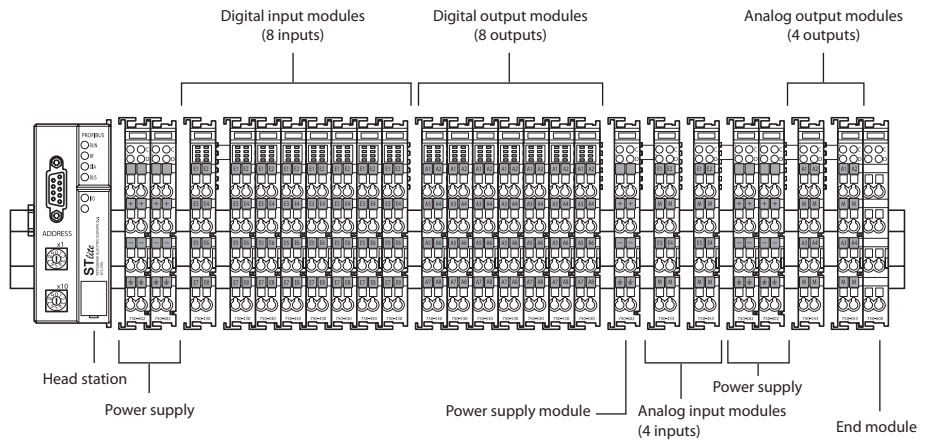

Electronic modules	Description
Head station	
STL-BT1	Head station CC-Link, 156 kBaud–10 MBaud; digital and analog signals
STL-PB1	Head station Profibus DP/V1, 12 MBaud; digital and analog signals
STL-ETH1	Head station Ethernet TCP/IP ECO, 10/100 Mbps; digital and analog signals
Power supply	
STL-PS	Power supply module 24 V DC, passive
STL-BPS	Power supply module 24 V DC, with bus power supply
Digital input modules	
STL-DI8-V1	Digital input module, 8 inputs, 24 V DC, 0.5 A, 0.2 ms, source type, 1-conductor connection
STL-DI8-V2	Digital input module, 8 inputs, 24 V DC, 0.5 A, source type
Digital output modules	
STL-DO4	Digital output module, 4 outputs, 24 V DC, 0.5 A, source type
STL-DO8	Digital output module, 8 outputs, 24 V DC, 0.5 A, source type
Relay output module	
STL-RO2	Relay output module, 2 N/O contacts, 230 V AC/30 V DC, 2A, potential-free
Analog input modules	
STL-AD2-V	Analog input module, 2 voltage inputs, 0–10 V DC, single-ended
STL-AD2-I	Analog input module, 2 current inputs, 4–20 mA, single-ended
STL-AD4-V1	Analog input module, 4 voltage inputs, 0–10 V DC, single-ended
STL-AD4-V2	Analog input module, 4 voltage inputs, ±10 V DC, single-ended
STL-AD4-I	Analog input module, 4 current inputs, 4–20 mA, single-ended
STL-TI2	Analog temperature input module, 2 temperature inputs, Pt100 and resistor measurement (selectable)
Analog output modules	
STL-DA2-V	Analog output module, 2 voltage outputs, 0–10 V DC
STL-DA2-I	Analog output module, 2 current outputs, 4–20 mA
STL-DA4-V1	Analog output module, 4 voltage outputs, 0–10 V DC
STL-DA4-V2	Analog output module, 4 voltage outputs, ±10 V DC
STL-DA4-I	Analog output module, 4 current outputs, 4–20 mA
Encoder module	
STL-ENC	Input module for incremental encoder
Counter module	
STL-C100	Input module with forward/reverse counter, 24 V DC, 100 kHz
Interface module	
STL-SSI	Input module with SSI encoder interface, 24 bit, 125 kHz
System module	
STL-ET	Bus end module
Accessory	
STL-CClink con	CC-Link fieldbus connector for CC-Link head station, D-Sub plug, 9-pole

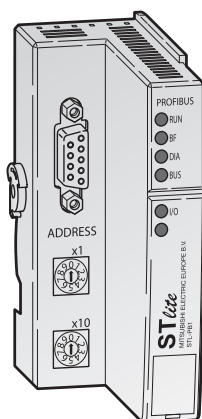

STlite series head stations

The head stations connect the STlite I/O systems with the Profibus DP, CC-Link or Ethernet fieldbus systems. Each head station recognises all inserted I/O and special function modules and generates a local process image from the configuration.

Mixed configurations of analog (word-wise communication) and digital (bit-wise communication) modules are supported. The stations have a large range of application protocols. The Ethernet head station also has an integrated server for web-based applications.

Specifications	STL-BT1	STL-PB1	STL-ETH1
Number of I/O modules	64	64	64
Communication	protocol	CC-Link-Standard	Profibus DP
	medium	Shielded Cu cable 2/3x0.5 mm ²	Cu cable acc. to EN 50170
Interface connector	D-Sub 9-pole	D-Sub 9-pole	RJ45
Max. transmission distance	m	1200 (depends on baud rate/cable)	100 between HUB and head station, max. network length limited by Ethernet specification
Fieldbus	input process image	256 bytes	244 bytes
	output process image	256 bytes	244 bytes
Number of addressable modules	64	96 with repeater	Limited by Ethernet specification
Station addresses	1/1-4	—	—
Internal current consumption (5 V DC)	mA	300	200
Max. input current (24 V DC)	mA	500	500
External power supply (24 V DC)		Via power supply module	Via power supply module
Wire connection		CAGE CLAMP®	CAGE CLAMP®
Dimensions (WxHxD)	mm	51x65x100	51x65x100
Order information	Art. no.	242280	242279
			242281

Accessories STL-CCLink con: Art. no. 242314
The fieldbus connector connects a CC-Link device to a CC-Link line.

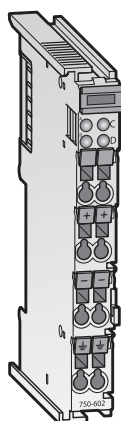

Power supply module

The power supply modules deliver power to the bus terminals at the required voltages. When configuring the system it is important that the total current does not exceed the maximum current flowing through the power input terminals. If this is the case an additional power supply module needs to be installed.

The power supply module with bus power supply increases the capacity of the system power supply for field bus nodes with high power requirements (sum of the internal power consumption values of the bus terminals). Additional power supply modules with bus power supply can be installed as required.

Specifications	STL-PS	STL-BPS
Voltage supply	24 V DC (-25 %—+30 %)	24 V DC (-25 %—+30 %)
Input current	max.	500
Total current for I/O modules	mA	2000
Voltage via power contacts	max.	24 V DC
Current via power contacts	max.	10 A DC
Wire connection	mA	CAGE CLAMP®
Module width		1 unit (12 mm)
Dimensions (WxHxD)	mm	12x65x100
Order information	Art. no.	242311
		242312

Bus end module

One of these end modules must be installed at the end of each fieldbus node. The end module terminates the internal

terminals bus and ensures reliable data communications.

Specifications	STL-ET
Module width	1 unit (12 mm)
Dimensions (WxHxD)	mm
Order information	Art. no.
	242313

Digital I/O modules

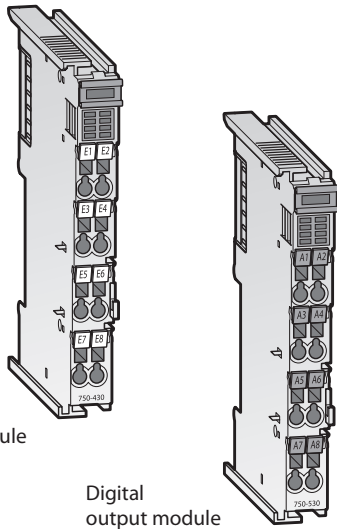

Digital input module

Digital output module

Digital input modules

The digital input modules have 8 channels. They are used for inputting control signals from the field, for example from sensors. Every input has an interference suppression filter, using a variety of time constants.

Digital output modules

Digital output modules are available with 4 or 8 outputs. They are used to send control signals from the automation controller to the connected actuators. All the outputs are short-circuit proofed.

The field and system levels are electrically isolated from one another in all digital input and output modules.

Digital relay output module

The relay output modules have two make contacts. The relays have floating contacts and are actuated with the internal system voltage. The control status of each relay is indicated by an LED.

Actuators with PE connections can be wired directly.

Specifications	STL-DI8-V1	STL-DI8-V2
Module type	Digital input module	Digital input module
Integrated inputs	8, source type, 1-conductor connection	8, source type, 1-conductor connection
Module width	1 unit (12 mm)	1 unit (12 mm)
Isolation method	Photo coupler	Photo coupler
Rated input voltage	(0): -3~+5 V DC/(1): 15~30 V DC	(0): -3~+5 V DC/(1): 15~30 V DC
Rated input current	2.8 mA	2.8
Response time	0.2 ms	3
Internal current consumption	17 mA	17
Dimensions (WxHxD)	mm 12x65x100	12x65x100
Wire connection	CAGE CLAMP®	CAGE CLAMP®
Order information	Art. no. 242282	242283

Specifications	STL-D04	STL-D08	STL-R02
Module type	Digital output module	Digital output module	Digital relay output module
Integrated outputs	4, source type	8, source type	2 contacts (normally open)
Module width	1 unit (12 mm)	1 unit (12 mm)	1 unit (12 mm)
Isolation method	Photo coupler	Photo coupler	Relay
Rated load voltage	24 V DC	24 V DC	—
Max. switching load	—	—	250 V AC/30 V DC
Max. load current	0.5/point A	0.5/point	2.0/point
Max. switching frequency	1 kHz	2 kHz	30/min (at rated load)
Response time	OFF → ON ms	—	max. 10
	ON → OFF ms	—	max. 10
Protection functions	Output short-circuit protected	Output short-circuit protected	—
Bounce time	—	—	type. 1.2 ms
Internal current consumption	7 mA	25	100
Dimensions (WxHxD)	mm 12x65x100	12x65x100	12x65x100
Wire connection	CAGE CLAMP®	CAGE CLAMP®	CAGE CLAMP®
Order information	Art. no. 242284	242295	242296

Analog I/O modules

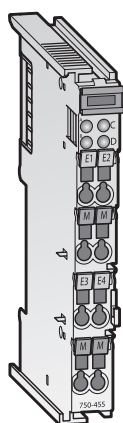

Analog input module

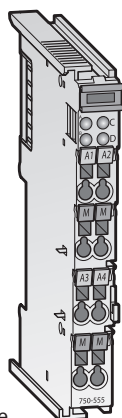

Analog output module

Analog input modules

The analog input modules with current input process standard 4–20 mA signals. The modules with voltage inputs can handle standard ± 10 V or 0–10 V signals.

The input signal is electrically isolated and is transferred to the system level with a resolution of 12 bits.

The modules are powered by the internal system power supply. The input channels of the modules have a common ground.

Analog output modules

The analog output modules with current outputs generate standard 4–20 mA signals. The modules with voltage outputs generate standard ± 10 V or 0–10 V signals.

The output signal is electrically isolated and is transferred to the system level with a resolution of 12 bits.

The power for the current output modules comes from the field power supply. The outputs of the voltage output modules are short-circuit proofed, have a common reference potential and are powered by the internal system power supply.

Specifications	STL-AD2-V	STL-AD2-I	STL-AD4-V1	STL-AD4-V2	STL-AD4-I
Module type	Analog input module	Analog input module	Analog input module	Analog input module	Analog input module
Module width	1 unit (12 mm)	1 unit (12 mm)	1 unit (12 mm)	1 unit (12 mm)	1 unit (12 mm)
Number of input channels	2	2	4	4	4
Signal input	0–10 V	4–20 mA	± 10 V	0–10 V	4–20 mA
Resolution	12 bit	12 bit	12 bit	12 bit	12 bit
Conversion time	2 ms	2 ms	10 ms	10 ms	10 ms
Maximum input voltage	35 V	10 V	± 40 V	± 40 V	32 V
Accuracy at 25 °C	$< \pm 0.2$ % of full scale value	$< \pm 0.1$ % of full scale value	$< \pm 0.1$ % of full scale value	$< \pm 0.1$ % of full scale value	$< \pm 0.2$ % of full scale value
Input resistance (per input)	130 Ω	$< 220 \Omega / 20$ mA	$> 100 \Omega$	$> 100 \Omega$	$> 100 \Omega / 20$ mA
Isolation method	Electrical isolation of the input channels				
Internal current consumption	60 mA	75	65	65	65
Dimensions (WxHxD)	12x65x100 mm	12x65x100	12x65x100	12x65x100	12x65x100
Wire connection	CAGE CLAMP®				
Order information	Art. no. 242297	242298	242299	242300	242301

Specifications	STL-DA2-I	STL-DA2-V	STL-DA4-V1	STL-DA4-V2	STL-DA4-I
Module type	Analog output module	Analog output module	Analog output module	Analog output module	Analog output module
Module width	1 unit (12 mm)	1 unit (12 mm)	1 unit (12 mm)	1 unit (12 mm)	1 unit (12 mm)
Number of output channels	2	2	4	4	4
Signal output	4–20 mA	0–10 V	0–10 V	± 10 V	4–20 mA
Resolution	12 bit	12 bit	12 bit	12 bit	12 bit
Conversion time	2 ms	2 ms	10 ms	10 ms	10 ms
Accuracy at 25 °C	$< \pm 0.1$ % of full scale value				
Data length	2x16 bit	2x16 bit	4x16 bit	4x16 bit	4x16 bit
External load resistance value	$< 600 \Omega$	5 k Ω	5 k Ω	5 k Ω	0–300 Ω / 300–600 Ω
Isolation method	Electrical isolation of the output channels				
Internal current consumption	70 mA	65	125	125	60
Dimensions (WxHxD)	12x65x100 mm	12x65x100	12x65x100	12x65x100	12x65x100
Wire connection	CAGE CLAMP®				
Order information	Art. no. 242302	242303	242304	242305	242306

Special function modules

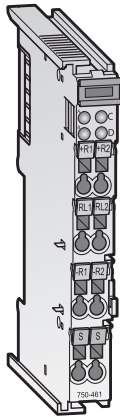

Temperature input module

The analog temperature input module enables direct connection of Pt100 resistance temperature sensors, with either a 2-wire or 3-wire cable. The module linearises the data across the entire supported temperature range.

Short circuits, sensor cable breaks and out-of-range values are signalled by a red error LED.

Specifications	STL-T12
Module type	Analog temperature input module
Number of input channels	2
Internal current consumption	80 mA
Sensor types	Pt100 and resistance measurement
Sensor connection	3-wire connection (factory preset) or 2-wire
Temperature measuring range	-200+850 °C (Pt100)
Resolution	0.1 °C
Conversion time	320 ms (per channel)
Accuracy at 25 °C	<±0.2 % of full scale value
Isolation method	Electrical isolation of the input channels
Rated measuring current	0.5 mA
Data length	2x16 bit
Wire connection	CAGE CLAMP®
Module width	1 unit (12 mm)
Dimensions (WxHxD)	mm 12x65x100
Order information	Art. no. 242307

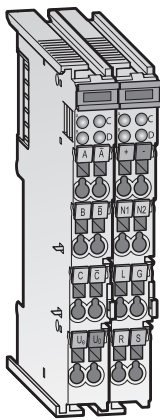

Incremental encoder input module

This module provides an interface for incremental encoders with an RS422 port. A counter with a quadrature decoder and a null point signal latch can be read and activated by the controller. The controller can also set the counter. In the corresponding operating mode, a rising edge signal at the input then loads the counter value into the latch register and initialises the counter.

The speed (increments/ms) is logged automatically and can be transmitted to the controller instead of the latch value. The gate input can be used to lock the counter. The ref input can be used to activate the null point function. The module uses cam outputs to signal whether the counter value is within the predefined windows. The module provides the power supply for the encoder.

Specifications	STL-ENC	
Module type	Incremental Encoder Interface	
Encoder connection	3 input channels	
Internal current consumption	110 mA	
Counting range	32 bits binary	
Max. counting frequency	250 kHz	
Decoder	Quadrature decoder with 4-fold report	
Resolution zero impulse	32 bit	
Commands	read, set, enable	
Current consumption (typ.)	35 mA without load	
Output voltage	5 V DC for sensor supply	
Max. output current	300 mA for sensor supply	
Data length	1x32 bit	
Digital outputs	output voltage	24 V DC
	max. output current	0.5 A
Protection functions	Output short-circuit protected	
Digital inputs	input voltage	(0): -3+5 V DC/(1): 15-30 V DC
	input current	5-7 mA
Wire connection	CAGE CLAMP®	
Module width	2 units (24 mm)	
Dimensions (WxHxD)	mm 24x65x100	
Order information	Art. no. 242308	

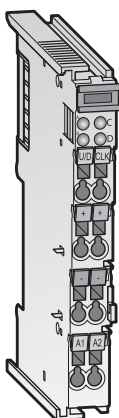

Up/Down counter module

This counter inputs binary 24V signals and transmits the counter value to the installed bus system. An input is used to switch between Up and Down counting.

The control byte can be used to switch two digital outputs and to set and reset the counter. It is also possible to lock the counter.

Specifications	STL-C100
Module type	Up/Down counter
Switching outputs	2
Counter inputs	1
Internal current consumption	mA 70
Max. output current	0.5 A
Rated input voltage	(0): -3--+5 V DC/(1): 15-30 V DC
Rated input current	mA 5
Max. counting frequency	100 kHz
Counting range	32 bit
Isolation method	Electrical isolation of the inputs and outputs
Data length	32 bit
Protection functions	Output short-circuit protected
Wire connection	CAGE CLAMP®
Module width	1 unit (12 mm)
Dimensions (WxHxD)	mm 24x65x100
Order information	Art. no. 242309

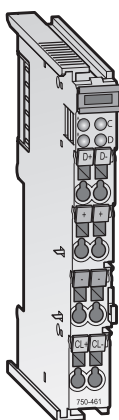

Interface modules

The SSI transmitter interface module enables direct connection of an SSI transmitter. To read out the transmitter the module emits a clock signal and represents the data flow as a data word in the process image. Control registers can be used to set different operating modes, transmission frequencies and bit widths.

The serial interface module enables connection of devices with an RS232C port. The connected device can then communicate directly with the controller via the fieldbus head station. The active communications channel has a data rate of 19,200 baud in full duplex mode, irrespective of the host bus system deployed.

The transmitter can be powered directly by the power output from the module.

Specifications	STL-SSI
Module type	Transmitter interface
Interface	SSI
Sensor connection	1 input/1 output channel
Internal current consumption	mA 85
Output voltage	24 V DC (-15--+20 % for sensor supply)
Transmission frequency/-rate	125 kHz (max. 1 MHz)
Data length serial input	32 bit
Signal output	Differential signal (RS422)
Signal input	Differential signal (RS422)
Signal coding	Gray-Code
Isolation method	Electrical isolation of the inputs and outputs
Data length	1x32 bit
Wire connection	CAGE CLAMP®
Module width	1 unit (12 mm)
Dimensions (WxHxD)	mm 24x65x100
Order information	Art. no. 242310

The MELSEC ST series – premium product for process industry

System description

The ST series is designed as a modular input/output system for connection to CC-Link and Profibus DP. It comprises of:

- basic module (head station and bus node for CC-Link and Profibus DP)
- power supply modules
- digital and analog I/O modules

They can be combined freely to provide an efficient system configuration depending on your demands.

The name „ST“ means „Slice-type Terminal“ and comes from the physical appearance of the very slim modules (12.6 mm). As well as slice type modules, cost saving block modules with 16 inputs or outputs are also available.

The extension modules are designed as a 2-component system, that means they consist of electronic modules for the function and base modules as modular backplane bus (available with two types of terminals: spring clamp or screw clamp terminals).

The electronic modules can be clipped easily in the base modules without any tool. The combined unit can then be mounted on a DIN rail. Exchange of the electronic modules can be made on-line, so the system keeps running. Re-wiring is not needed.

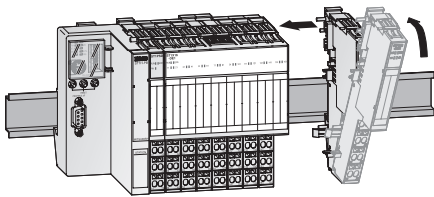

Every electronic module provides LEDs for quick and easy diagnostics and also additional information. Error and status messages are also shown on the basic module.

Special features:

- ST = Slice terminals, only 12.6 mm wide
- Modular structure with no restriction on installation position
- Easy and complete handling via 3 push buttons
- Connection diagram on every module
- Applicable wire size for all base modules 0.5–2.5 mm², flexible wire with ferrule or solid core wire without ferrule
- Expandable in two-point increments
- Replaceable electronic modules
- Hot swap function without re-wiring
- Quick diagnostics via LED's
- Distributed 24 V DC for actuators/sensors
- Gold contacts for all bus and signal connections
- Electronic modules are coded to prevent an incorrect unit being inserted
- Easy parameter setting with GX Configurator DP

Product range

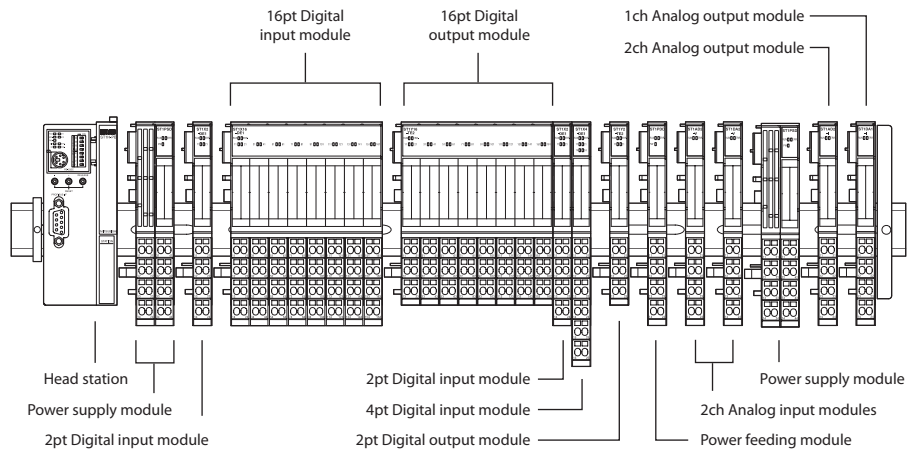

Product range and selection guide

The following table shows the possible combinations between electronic modules and the applicable base modules. However, two types of base modules featuring spring clamp terminals or screw clamp terminals are available. Choose the best solution for your special application.

Electronic modules	Base modules Spring clamp terminals	Screw clamp terminals
Head station		
ST1H-BT (CC-Link)	—	—
ST1H-PB	no need	no need
Power supply modules		
ST1PSD (first one)	ST1B-S4P2-H-SET	ST1B-E4P2-H-SET
ST1PSD (second and more)	ST1B-S4P2-R-SET	ST1B-E4P2-R-SET
ST1PDD	ST1B-S4P2-D	ST1B-E4P2-D
Digital input modules		
ST1X2-DE1	ST1B-S4X2	ST1B-E4X2
ST1X4-DE1	ST1B-S6X4	ST1B-E6X4
ST1X16-DE1	ST1B-S4X16	ST1B-E4X16
ST1X1616-DE1-S1	ST1B-S6X32	ST1B-E6X32
Digital output modules		
ST1Y2-TE2	ST1B-S3Y2	ST1B-E3Y2
ST1Y16-TE2	ST1B-S3Y16	ST1B-E3Y16
ST1Y16-TE8	ST1B-S3Y16	ST1B-E3Y16
ST1Y2-TPE3	ST1B-S3Y2	ST1B-E3Y2
ST1Y16-TPE3	ST1B-S3Y16	ST1B-E3Y16
ST1Y2-R2	ST1B-S4IR2	ST1B-E4IR2
Analog input modules		
ST1AD2-V	ST1B-S4IR2	ST1B-E4IR2
ST1AD2-I	ST1B-S4IR2	ST1B-E4IR2
Analog output modules		
ST1DA2-V-F01	ST1B-S4IR2	ST1B-E4IR2
ST1DA1-I-F01	ST1B-S4IR2	ST1B-E4IR2
Temperature modules		
ST1TD2	ST1B-S4TD2	ST1B-E4TD2
ST1RD2	ST1B-S4IR2	ST1B-E4IR2
Encoder module		
ST1SS1	ST1B-S4IR2	ST1B-E4IR2

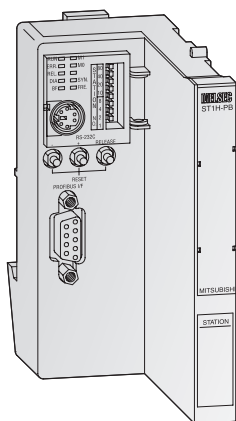

Basic module (head station) of the MELSEC ST series

The basic module ST1H-PB connects the remote I/O modules of the ST series to CC-Link and Profibus DP.

The ST1H-PB provides a Mini-DIN socket for diagnostics and parameter setting. The station number can be set via DIP switches on the basic module. LEDs show the status of the connected systems.

Specifications	ST1H-BT	ST1H-PB
Occupied I/O points	4 inputs/4 outputs	4/4
Communications	protocol	CC-Link standard
	medium	CC-Link cable
Interface	type	CC-Link
		RS485
Supported operation modes	Remote station (1–4)	Sync mode, freeze mode
Max. transmission distance	1200 m	4800 (3 repeaters)
Programming interface	RS232 mini-DIN connector for diagnostics and programming	RS232 Mini-DIN socket for diagnostics and programming
Data exchange with master	304 total/32/64/128/256 I/Os, mode selectable	304 total/32/64/128/256, selectable mode
Number of addressable slices	Max. 63	Max. 63
Addressable I/O points	digital bit	252
	analog word	52
Internal power consumption (5 V DC)	410 mA	530 mA
External power supply	Via ST1PSD	Via ST1PSD
Dimensions (WxHxD)	mm 50.5x114.5x74.5	50.5x114.5x74.5
Order information	Art. no. 214496	152951

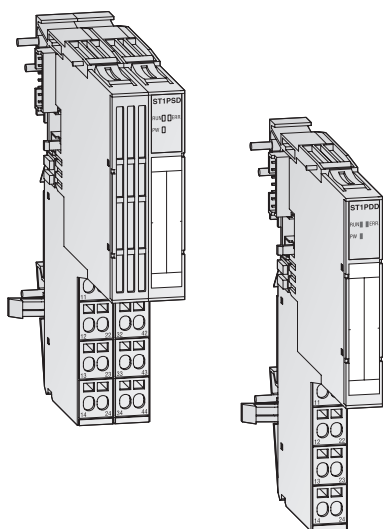

Bus power for head station

The bus power supply and refresh module ST1PSD can serve in two ways: distribute 24 V DC power supply for the basic module and I/O devices plus 5 V DC for the internal backplane bus (H mode) or distribute 24 V DC power supply for I/O devices and refresh the internal backplane bus with 5 V DC (R mode). Each mode (H or R) is indicated by the use of a different base module, marked with „H“ or „R“.

You need 1 ST1PSD with H-type base module beside the basic module to operate the ST station, a second or more (using the R-type base module) are only needed depending on the power consumption of the connected items (see bottom of this page).

LEDs on the module show the status for RUN and ERROR. Diagnosis can be made via the head module.

Power feeding module

The power feeding module ST1PDD distributes 24 V DC only for the I/Os of the actuators and sensors.

The number of ST1PDD modules needed can be calculated individually by addition of the current consumption of all connected devices.

The electronic module is fitted in a base module, which can be installed on a standard DIN rail.

Specifications	ST1PSD	ST1PDD
Module type	Power supply for head station, internal 5 V DC backplane bus and 24 V DC for I/Os (double function)	Power feeding module
Occupied I/O points	2/2	2/2
Occupied slice number	2	1
Nominal voltage	V DC 24.0	24.0
Permissible range	24.0 (19.2–28.8 (±20 %))	24.0 (19.2–28.8 (±20 %))
System supply	V DC 24.0 for basic module and I/Os, field supply/5.0 for internal backplane bus	
Ripple	<5 %	<5 %
Internal power consumption (5 V DC)	mA —	60
Max. output current (5 V DC)	A 2.0	—
Max. output current (24 V DC)	A 8 (10 with fuse)	8 (10 with fuse)
Dimensions (WxHxD)	mm 25.2x55.4x74.1	12.6x55.4x74.1
Order information	Art. no. 152952	152953
Applicable base module for basic module supply	spring clamp type	ST1B-S4P2-H-SET, art. no. 152908
	screw clamp type	ST1B-E4P2-H-SET, art. no. 152918
Applicable base module for bus refreshing within the station	spring clamp type	ST1B-S4P2-R-SET, art. no. 152909
	screw clamp type	ST1B-E4P2-R-SET, art. no. 152919

Note: Calculation of the power consumption

The power consumption and the need of a power refresh module will be calculated exactly in the GX Configurator DP during your configuration of the System.

For a rough calculation of the internal 5 V DC power consumption and a rough calculation for the number of needed PSD refresh modules, please refer to the attached table.

Module type	Power supply/consumption	Description
ST1PSD	2.0 A	Power supply infeed
ST1H-PB	0.53 A	Power consumption
Slicemodule	0.1 A	Power consumption
Blockmodule	0.15 A	Power consumption

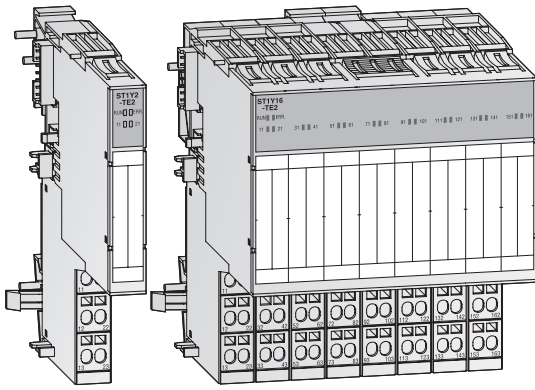

Digital input modules

The digital input modules of the ST series directly connect field devices (contacts, limit switches, sensors, etc.) on to a Profibus DP ST series slave node.

Digital output modules

The digital output modules of the ST series connect directly to field devices (e.g. contactors, valves, lights) and Profibus DP master module.

The TPE3 models provide advanced protection functions e.g. for thermal and short circuit failures.

The electronic modules are fitted in a base module, which can be installed on a standard DIN rail. Each module can be replaced without having to turn OFF the power („Hot Swap“), without rewiring and without using any tool.

- DIN rail mounting
- LEDs for RUN and ERROR on the modules and also on the basic module
- Connection to the basic module (head station) via integrated backplane bus in the base modules
- Two selectable types of connecting terminals base modules:
 - spring clamp type terminals
 - screw clamp type terminals

Specifications	ST1X2-DE1	ST1X4-DE1	ST1X16-DE1	ST1X1616-DE1-S1
Module type	DC input module, 2 inputs	DC input module, 4 inputs	DC input module, 16 inputs	DC input module, 32 inputs
Occupied I/O points	2/2	4/4	16/16	16/16
Occupied slice number	1	1	8	8
Isolation method	Photo coupler	Photo coupler	Photo coupler	Photo coupler
Rated input voltage	V DC 24 (+20/-15 %, ripple ratio within 5 %)	24 (+20/-15 %, ripple ratio within 5 %)	24 (+20/-15 %, ripple ratio within 5 %)	24 (+20/-15 %, ripple ratio within 5 %)
Rated input current	mA 4	4	4	5
Inputs simultaneous ON	100 %	100 %	100 %	100 %
Input resistance	k Ω 5.6	5.6	5.6	4.7
Response time	OFF → ON ms 0.5/1.5 or less (default: 1.5) ON → OFF ms 0.5/1.5 or less (default: 1.5)			
Internal current consumption (5 V DC)	mA 85	95	120	200
Dimensions (WxHxD)	mm 12.6x55.4x74.1	12.6x55.4x74.1	100.8x55.4x74.1	100.8x55.4x74.1
Applicable base module	spring clamp type ST1B-S4X2, art. no. 152911 screw clamp type ST1B-E4X2, art. no. 152921	ST1B-S6X4, art. no. 152912 ST1B-E6X4, art. no. 152922	ST1B-S4X16, art. no. 152913 ST1B-E4X16, art. no. 152923	ST1B-S6X32, art. no. 169313 ST1B-E6X32, art. no. 169314
Connection cable type	3-wire 24 V DC (with shield)	3-wire 24 V DC	3-wire 24 V DC (with shield)	3-wire 24 V DC (with shield)
Order information	Art. no. 152964	152965	152966	169309

Specifications	ST1Y2-TE2	ST1Y16-TE2	ST1Y2-TE8	ST1Y2-TPE3	ST1Y16-TPE3	ST1Y2-R2
Module type	2 transistor outputs	16 transistor outputs	2 transistor outputs	2 transistor outputs	16 transistor outputs	Relay output
Occupied I/O points	2/2	16/16	2/2	2/2	16/16	2/2
Occupied slice number	1	8	1	1	8	1
Isolation method	Photo coupler	Photo coupler	Photo coupler	Photo coupler	Photo coupler	Relay
Rated load voltage	24 V DC (+20/-15 %)	24 V DC (+20/-15 %)	24 V DC (+20/-15 %)	24 V DC (+20/-15 %)	24 V DC (+20/-15 %)	24 V DC (+20/-15 %); 240 V AC
Max. load current	A 0.5/point; 1.0/common	0.5/point; 4.0/common	2.0/point; 4.0/common	1.0/point; 2.0/common	1.0/point; 4.0/common	2.0 (cos φ=1)/point; 4.0/common
Max. switching load	—	—	—	—	—	264 V AC/125 V DC
Max. inrush current	A 4.0 (10 ms or less)	4.0 (10 ms or less)	4.0 (10 ms or less)	2.0 (10 ms or less)	4.0 (10 ms or less)	—
Leakage current OFF	mA 0.1 or less	0.1 or less	0.1 or less	0.3 or less	0.3 or less	—
Max. voltage drop at ON	0.2 V DC (TYP) 0.5 A, 0.3 V DC (max.) 0.5 A	0.2 V DC (TYP) 0.5 A, 0.3 V DC (max.) 0.5 A	0.2 V DC (TYP) 2.0 A, 0.3 V DC (max.) 2.0 A	0.15 V DC (TYP) 1.0 A, 0.2 V DC (max.) 1.0 A	0.15 V DC (TYP) 1.0 A, 0.2 V DC (max.) 1.0 A	—
Response time	OFF → ON ms max. 1.0 ON → OFF ms max. 1.0 (rated load, resistive load)	max. 1.0 max. 1.0 (rated load, resistive load)	max. 1.0 max. 1.0 (rated load, resistive load)	max. 0.5 max. 1.5 (rated load, resistive load)	max. 0.5 max. 1.5 (rated load, resistive load)	max. 10 max. 12
Protection functions	—	—	—	Thermal protection, short circuit protection (thermal and short circuit protection are activated in increments of 1 points. When the output section protection function is working, LED indicates it and signal is output to head module (automatic reset).		—
Internal current consumption (5 V DC)	mA 90	150	95	95	160	90
Dimensions (WxHxD)	mm 12.6x55.4x74.1	100.8x55.4x74.1	12.6x55.4x74.1	12.6x55.4x74.1	12.6x55.4x74.1	12.6x55.4x74.1
Applicable base module	spring clamp type ST1B-S3Y2, art. no. 152914 screw clamp type ST1B-E3Y2, art. no. 152924	ST1B-S3Y16, art. no. 152915 ST1B-E3Y16, art. no. 152925	ST1B-S3Y16, art. no. 152915 ST1B-E3Y16, art. no. 152925	ST1B-S3Y2, art. no. 152914 ST1B-E3Y2, art. no. 152924	ST1B-S3Y16, art. no. 152915 ST1B-E3Y16, art. no. 152925	ST1B-S4IR2, art. no. 152916 ST1B-E4IR2, art. no. 152927
Connection cable type	2-wire 24 V DC with shield	2-wire 24 V DC with shield	2-wire 24 V DC with shield	2-wire 24 V DC with shield	2-wire 24 V DC with shield	2 wires (internal connected)
Order information	Art. no. 152967	152968	169408	152969	152970	152971

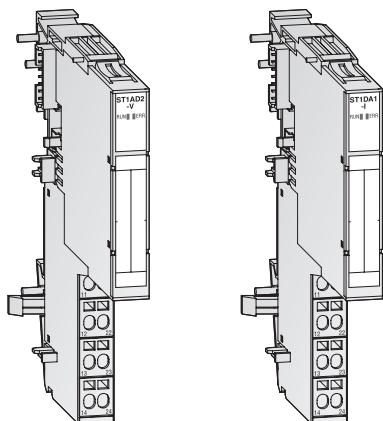

Analog input modules

The analog input modules of the ST series convert analog process data like pressure, temperature, etc. into digital values that are sent to the Profibus DP master.

Analog output modules

The analog output modules of the ST series convert the digital values sent from the Profibus DP master into an analog voltage signal. This signal can be used to control valves, inverters, servomotors, etc.

Analog temperature input module

The analog temperature input modules of the ST series convert analog temperature data into digital values that are sent to the Profibus DP master.

All modules are fitted in a base module, which can be installed on a standard DIN rail.

- DIN rail mounting
- LEDs for RUN and ERROR on the modules and also on the basic module
- Connection to the basic module (head station) via integrated backplane bus in the base modules
- Modules can be replaced without having to turn OFF the power („Hot Swap“)
- Two selectable types of connecting terminals base modules:
 - spring clamp type terminals
 - screw clamp type terminals

Specifications	ST1AD2-V	ST1AD2-I	ST1TD2	ST1RD2
Module type	Analog input module	Analog input module	Analog temperature input module	Analog temperature input module
Occupied I/O points	4/4	4/4	4/4	4/4
Occupied Slice number	1	1	2	2
Number of input channels	2	2	2	2
Signal input	-10~+10 V, 0~+10 V, 0~5 V, 1~5 V	0~20 mA, 4~20 mA	Thermocouple input: K, T: 0.3 °C; E: 0.2 °C; J: 0.1 °C; B: 0.7 °C; R, S: 0.8 °C; N: 0.4 °C	Pt100, Pt1000
Resolution	12 bit + sign	12 bit + sign	Microvoltage: 4 μV	0.1 °C
Conversion speed	0.1 ms per channel	0.1 ms per channel	Cold junction temperature compensation setting: not set: 30 ms/channel; set: 60 ms/channel	80 ms per channel
Maximum input voltage	±15 V	—	±4 V	—
Micro voltage input range	—	—	-80~+80 μV (input resistance <1 MΩ)	—
Maximum input current	—	±30 mA	—	—
Output	temperature conversion micro conversion	—	16-bit signed binary (-2,700~18,200) 16-bit signed binary (-20,000~20,000)	16-bit signed binary (-2,000~8,500)
Total error	±0.8 % (0~55 °C)	±0.8 % (0~55 °C)	±0.32 mV (0~55 °C)	±1.2 °C (0~55 °C)
Input resistance at single-end	1.0 MΩ	250 Ω	1 MΩ	1 MΩ
Isolation	Photo coupler isolation between the channels and backplane bus			
Internal current consumption (5 V DC)	mA 110	110	95	80
Dimensions (WxHxD)	mm 12.6x55.4x74.1	12.6x55.4x74.1	12.6x55.4x77.6	12.6x55.4x77.6
Applicable base module	spring clamp type screw clamp type	ST1B-S4IR2, art. no. 152916 ST1B-E4IR2, art. no. 152927	ST1B-S4TD2, art. no. 161736 ST1B-E4TD2, art. no. 161737	ST1B-S4RD2, art. no. 161736 ST1B-E4RD2, art. no. 161737
Order information	Art. no. 152972	152973	161734	169406

Specifications	ST1DA2-V-F01	ST1DA1-I-F01	ST1SS1
Module type	Analog output module	Analog output module	Absolute encoder interface with SSI (synchronous serial interface)
Occupied I/O points	4/4	4/4	4/4
Occupied slice number	1	1	2
Number of output channels	2	1	1
Signal output range	-10~+10 V, 0~+10 V, 0~5 V, 1~5 V	0~20 mA, 4~20 mA	31 bit binary (0~2147483647)
Resolution	12 bit + sign	12 bit + sign	2 to 31 bits
Conversion time	0.1 ms per channel	0.1 ms per channel	125 kHz, 250 kHz, 500 kHz, 1 MHz, 2 MHz
Maximum input voltage	±12 V	—	24 V DC (+20/-15 %)
Maximum input current	—	±30 mA	12 mA
Total error	±0.8 % (0~55 °C)	±0.8 % (0~55 °C)	±0.8 % (0~55 °C)
Data length	16 bit	16 bit	—
External load resistance value	1.0 kW~1.0 MW	0~500 W	—
Isolation	Photo coupler isolation between the channels and backplane bus		Photo coupler isolation between the channels and backplane bus
Internal current consumption (5 V DC)	mA 95	95	80
Dimensions (WxHxD)	mm 12.6x55.4x74.1	12.6x55.4x74.1	12.6x55.4x74.1
Applicable base module	spring clamp type screw clamp type	ST1B-S4IR2, art. no. 152916 ST1B-E4IR2, art. no. 152927	ST1B-S4IR2, art. no. 152916 ST1B-E4IR2, art. no. 152927
Order information	Art. no. 152975/217631	152976/217632	193660

Modular PLCs MELSEC System Q

MELSEC System Q has been designed to be at the heart of your manufacturing process, as it is at the heart of Mitsubishi Electric's component automation concept. It offers you total integration of your control and communication needs from a single platform – connecting your automation with your business needs.

- Communication – is a communication hub connecting to fieldbus or data networks including 100 Mbps Ethernet
- Scalability – offers Multi CPU solutions on a single backplane
- Flexibility – solutions can combine 4 CPU types as a seamless solution; PLC, Motion, Robots, NC, PC and Process CPUs
- Visualisation – integrates your business data to whatever level and function you need, from HMI, Soft HMI through to SCADA and OPC
- MES and web server module for quick and simple connectivity to the IT world
- Redundancy options ranging from full redundant PLC hardware to redundant network options improve uptime and productivity

Equipment features

The modular design of MELSEC System Q allows flexible usage in a broad range of applications. The following modules are available for assembling the system:

To maximize the operational safety, all modules are isolated electrically by means of optocouplers.

Use of digital and special function modules

The use of digital and analog modules and most special function modules is dependent only on the maximum available number of addresses and thus on the CPU used in each case.

4

Modular PLCs

Pulse catch and interrupt modules

Digital input modules for pulse storage and for processing subroutines.

Communications modules

Interface modules with RS232/RS422/RS485 interface for connection of peripherals or for PLC-PLC communication.

Network modules

For interfacing with Ethernet, CC-Link, CC-Link IE, Profibus DP/Profinet, Modbus TCP/RTU, DeviceNet, AS-Interface and MELSEC networks.

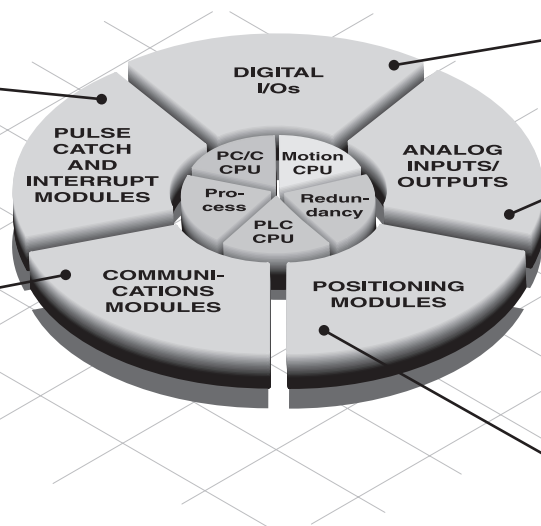

Digital input/output modules

For various signal levels with transistor, relay or triac switches.

Analog input/output modules

For processing current/voltage signals and for temperature value acquisition as well as temperature control with direct connection of Pt100 resistance thermometers or thermocouples. A HART enabled module for current input is also available.

Positioning modules

High-speed counter modules with possibility for connection of incremental shaft encoder or multiaxial positioning modules for servo and step drives with up to 8 axes per module.

iQ Platform

The universal automation solution for maximising ROI

Mitsubishi Electric's iQ Platform is the hardware foundation for our e-F@ctory concept – an advanced, integrated automation strategy based on our long experience and expertise as a global manufacturing company. The main features of iQ Platform include:

- Minimum Total Cost of Ownership
- Seamless integration
- Maximum productivity
- Transparent communications

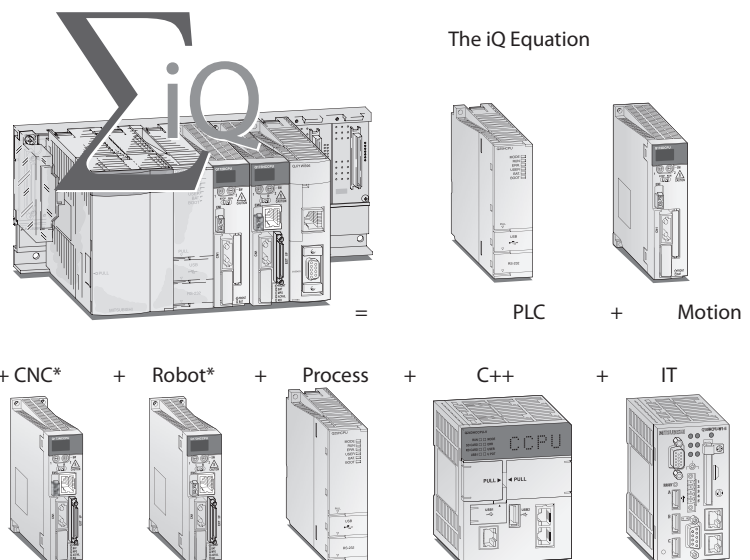

* Description follows

What a system looks like

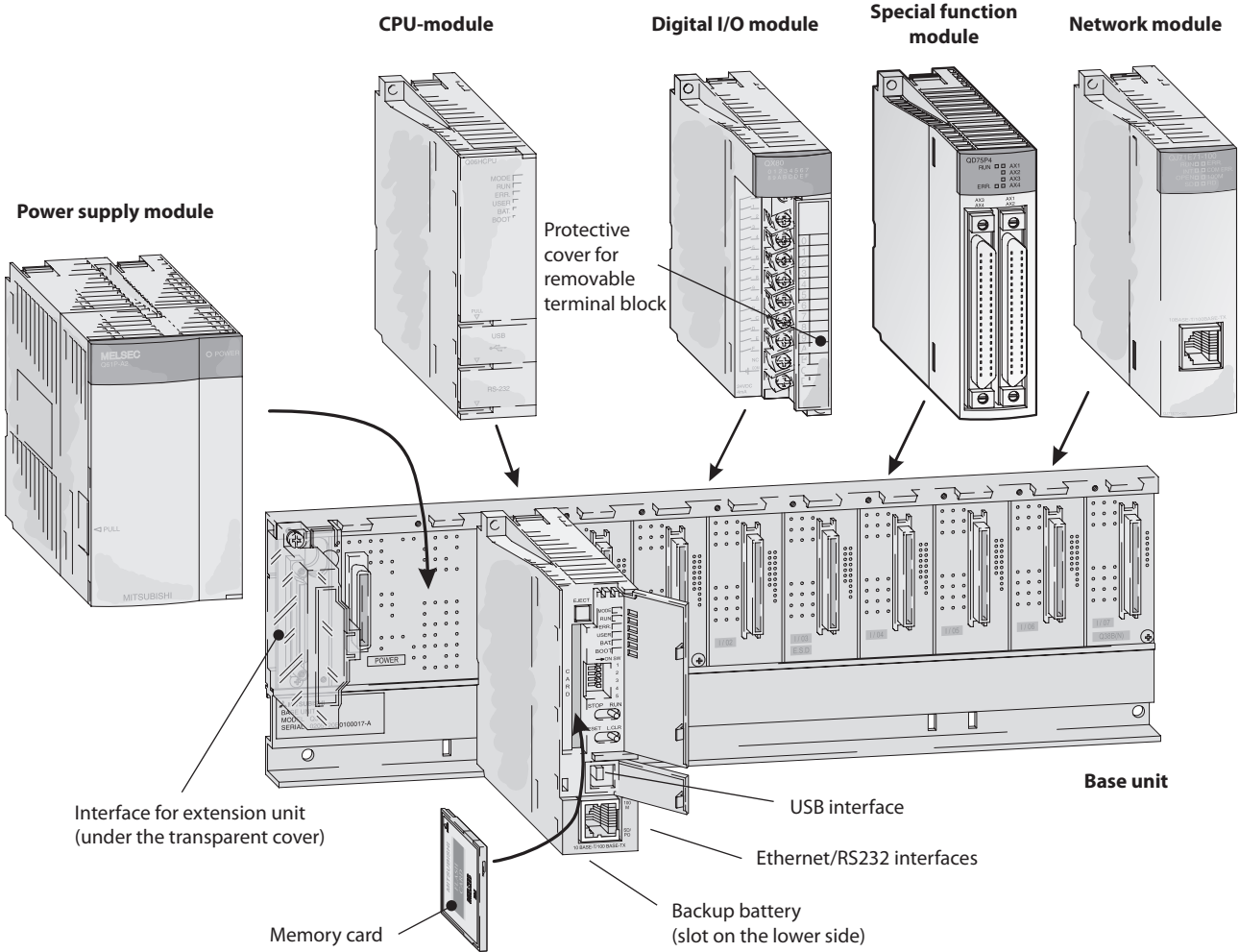

System structure

The CPU and modules are connected to a base unit which has an internal bus connection for communication between the individual modules and the CPUs. The power supply module which supplies the voltage for the entire system is also installed on this base unit. The base units are available in 4 different versions with 3 to 12 module slots.

Each base unit can be supplemented by means of an extension unit providing additional slots. If you wish to keep open the option of subsequent extension of your PLC or if you have free slots on your base unit, you can insert dummy modules in vacant module positions.

They serve to protect the free slots from soiling or from mechanical effects and can also be used for reserving I/O points. For cabling larger systems and machines – e.g. in a modular design – the use of remote I/O modules offers additional communications facilities.

What you need

Base units

The base unit is for mounting and connecting all modules and provides power and communication buses between modules. There is a minimum of one base unit per system but extension base units can be added, with or without power supply modules up to a maximum of 7 extension bases (depending on CPU model).

Power supply

This provides 5 V DC power for all modules on the back plane. There are several types of power supplies available, the selection is dependent on

each individual modules power consumption and available supply voltage. You can only use one power supply per backplane.

CPU

There are three main CPU types: Basic models (Q00JCPU through Q01CPU), advanced models (Q02CPU through Q25HCPU) and universal models (Q00UJ through Q100UDEHCPU). Up to 4 CPUs can be used in a single system, which allows a wide range of combinations for optimal system performance.

I/O

There is a wide selection of digital input and output modules depending on the signal level, sink or source designation, density of points required and support for AC or DC voltage. Modules are available in 16 point input or output with screw terminals mounted on the module, higher densities of 32 and 64 point require a connector, cable and terminal block.

Base units

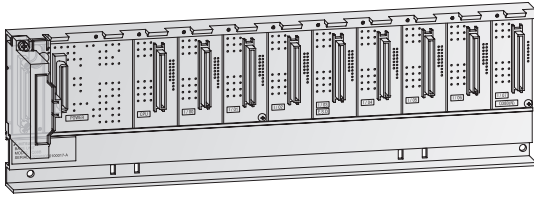

Main base units

The main base unit is used for mounting and connecting CPUs, power supply unit, input modules, output modules and special function modules.

- The modules are automatically addressed
- The units are mounted by means of screws or on a profiled rail with an integrated adapter

Specifications	Q32SB	Q33B	Q33SB	Q35B	Q35SB	Q35DB	Q38B	Q38DB*	Q38RB	Q312B	Q312DB*	
Slots for I/O modules	2	3	3	5	5	5	8	8	8	12	12	
Slots for power supply modules	1	1	1	1	1	1	1	1	2	1	1	
Installation	All base units provide installation holes for M4 screws.											
Dimensions (WxHxD)	mm	114x98x18.5	189x98x44.1	142x98x18.5	245x98x44.1	197.5x98x18.5	245x98x44.1	328x98x44.1	328x98x44.1	439x98x44.1	439x98x44.1	
Order information	Art. no.	147273	136369	147284	127586	147285	249091	127624	207608	157067	129566	207609
Accessories	Connection cables, adapter for DIN rail mounting											

* These base units are required for the new iQ Platform motion, NC and robot CPUs.

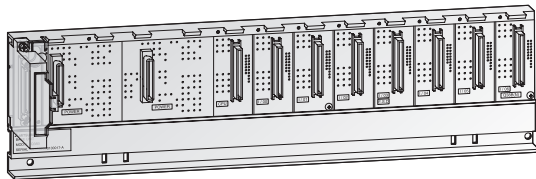

Extension base units

The extension base units are connected to the main base unit by means of pre-assembled bus cables.

An extension base unit with a power supply module must be used in the following cases:

- Q6*B extension units provide a slot for their own power supply module
- A total of max. 7 extension units can be connected to a main base unit with up to 64 I/O modules for a single system
- The maximum distance from the first to the last base unit is 13.2 m
- If the power consumption of the inserted modules exceeds the capacity of the power supply module on the base unit
- If the voltage drops below 4.75 V between the base unit and the extension unit

Specifications	Q52B	Q55B	Q63B	Q65B	Q68B	Q68RB	Q612B	Q65WRB	QA1551B	
Slots for power supply modules	—	—	1	1	1	2	1	1	—	
Slots for I/O modules	2	5	3	5	8	8	12	5	1	
Installation	All base units provide installation holes for M4 screws.									
Dimensions (WxHxD)	mm	106x98x44.1	189x98x44.1	189x98x44.1	245x98x44.1	328x98x44.1	439x98x44.1	439x98x44.1	100x130x50.7	
Order information	Art. no.	140376	140377	136370	129572	129578	157066	129579	210163	249092
Accessories	Connection cables adapter for DIN rail mounting									

Power supply modules

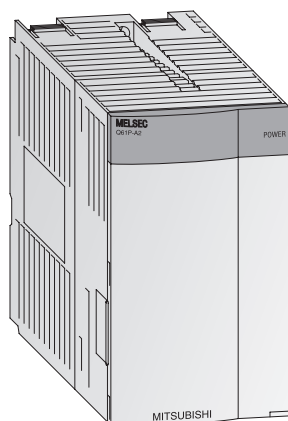

These units power all the modules on the backplane. The choice is dependent on the power consumption of the individual modules (this is especially important when using multiple CPUs).

- LED indicator shows operating status
- Use Q63P for applications powered by 24 V DC
- The power supply module Q62P can be used world-wide with its wide input range from 100 to 240 V AC at 50/60 Hz

Specifications		Q61P	Q61P-D	Q61SP	Q62P	Q63P	Q63RP	Q64PN	Q64RP
Input voltage	(+10 %, -15 %) V AC	85–264	100–240	85–264	100–240	—	—	100–240	100–240
	(+30 %, -35 %) V DC	—	—	—	—	24	24	—	—
Input frequency	Hz	50/60 (±5 %)	50/60 (±5 %)	50/60 (±5 %)	50/60 (±5 %)	—	—	50/60 (±5 %)	50/60 (±5 %)
Inrush current		20 A within 8 ms	20 A within 8 ms	20 A within 8 ms	20 A within 8 ms	81 A within 1 ms	150 A within 1 ms	20 A within 1 ms	20 A within 1 ms
Max. input apparent power		120 VA	130 VA	40 VA	105 VA	45 W	65 W	160 VA	160 VA
Rated output current	5 V DC	A	6	6	2	3	6	8.5	8.5
	24 V DC ±10 %	A	—	—	—	0.6	—	—	—
Overcurrent protection	5 V DC	A	≥6.6	≥6.6	≥2.2	≥3.3	≥5.5	≥5.5	≥9.9
	24 V DC	A	—	—	—	≥0.66	—	—	—
Overvoltage protection	5 V DC	V	5.5–6.5	5.5–6.5	5.5–6.5	5.5–6.5	5.5–6.5	5.5–6.5	5.5–6.5
Efficiency			≥70 %	≥70 %	≥70 %	≥65 %	≥70 %	≥65 %	≥70 %
Insulation withstand voltage	between primary and 5 V DC		2830 V AC, 1 min.	2830 V AC, 1 min.	2830 V AC, 1 min.	2830 V AC, 1 min.	500 V AC, 1 min.	500 V AC, 1 min.	2830 V AC, 1 min.
	between primary and 24 V DC		—	—	—	2830 V AC, 1 min.	—	—	—
Max. compensation time at power failure	ms	20	20	20	20	10	10	20	20
Dimensions (WxHxD)	mm	55.2x98x90	55.2x98x90	27.4x98x104	55.2x98x90	55.2x98x90	83x98x115	55.2x98x115	83x98x115
Order information	Art. no.	190235	221860	147286	140379	136371	166091	217627	157065

PLC CPU modules

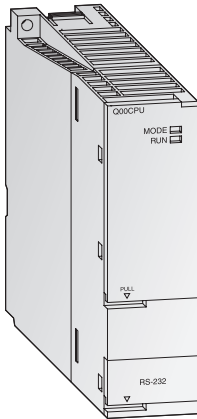

The CPU modules of the MELSEC System Q are available as single and multi processor CPUs through which they achieve a wide application range. The performance of the controller can match the application by simply replacing the CPU (except Q00J).

Basic PLC CPUs

While Q00CPU and Q01CPU are separate CPUs, the Q00JCPU forms an inseparable unit consisting of CPU, power supply and base unit and thus enables a low-priced entry into the modular PLC technology.

These CPUs were developed especially for applications where compact system configuration is important.

- Every CPU is equipped with an RS232C interface for easy programming and monitoring from a personal computer or operating panel.
- Integrated Flash ROMs for memory operation without additional memory cards
- Processing the inputs and outputs with refresh mode for optimal response

Specifications	Q00JCPU	Q00CPU	Q01CPU
Type	Combination of CPU module (single processor), 5 slot base unit and power supply	CPU module (single processor)	CPU module (single processor)
I/O device points	256/2048	1024/2048	1024/2048
CPU self-diagnostic functions	CPU error detection, Watch Dog, battery error detection, memory error detection, program check, power supply error detection, fuse error detection		
Battery buffer	All CPU modules are fitted with a lithium-battery with a life expectancy of 5 years.		
Memory type	ROM	RAM, ROM	RAM, ROM
Memory capacity	overall	58 kByte	94 kByte
	max. for PLC program	8 k steps (32 kByte)	14 k steps (56 kByte)
Program cycle period	0.20 μs/log. instruction	0.16 μs/log. instruction	0.10 μs/log. instruction
No. of instructions	318	327	327
Dimensions (WxHxD)	mm 245x98x98	27.4x98x89.3	27.4x98x89.3
Order information	Art. no. 138322	138323	138324
The CPU can be replaced by:	Q00JCPU	Q00CPU	Q01CPU

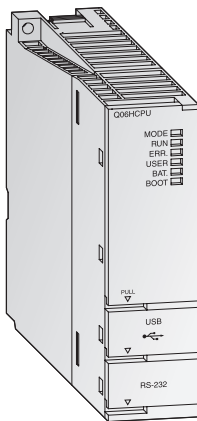

High-performance PLC CPUs

With the high-performance CPUs fast processing speed and expandability are the key features. Flexible system configuration that suits a wide range of applications is possible due to a varied set of functions and a well designed programming, configuration and debugging environment.

In total five different high-performance CPUs with graded performance are available for the MELSEC System Q. All versions are upwardly compatible. Thus, the MELSEC System Q can grow with the application by changing the CPU.

- Q02HCPU and upwatsds are equipped with a USB interface for easy programming and monitoring from a personal computer
- Processing the inputs and outputs with refresh mode for optimal response
- Floating point arithmetic according to IEEE 754
- Special statements for processing PID control loops
- Mathematical functions, such as angle/exponential functions and logarithm

Specifications	Q02CPU	Q02HCPU	Q06HCPU	Q12HCPU	Q25HCPU
Type	Multi processor CPU module				
I/O points	4096/8192	4096/8192	4096/8192	4096/8192	4096/8192
CPU self-diagnostic functions	CPU error detection, Watch Dog, battery error detection, memory error detection, program check, power supply error detection, fuse error detection				
Battery buffer	All CPU modules are fitted with a lithium-battery with a life expectancy of 5 years.				
Memory type	RAM, ROM, FLASH	RAM, ROM, FLASH	RAM, ROM, FLASH	RAM, ROM, FLASH	RAM, ROM, FLASH
Memory capacity	overall	≤32 MByte	≤32 MByte	≤32 MByte	≤32 MByte
	max. for PLC program	28 k steps (112 kByte)	28 k steps (112 kByte)	60 k steps (240 kByte)	124 k steps (496 kByte)
Program cycle period	79 ns/log. instruction	34 ns/log. instruction	34 ns/log. instruction	34 ns/log. instruction	34 ns/log. instruction
Dimensions (WxHxD)	mm 27.4x98x89.3	27.4x98x89.3	27.4x98x89.3	27.4x98x89.3	27.4x98x89.3
Order information	Art. no. 132561	127585	130216	130217	130218
The CPU can be replaced by:	Q03UD/UDECPU	Q03UD/UDECPU	Q06UDH/UDECPU	Q13UDH/UDECPU	Q26UDH/UDECPU

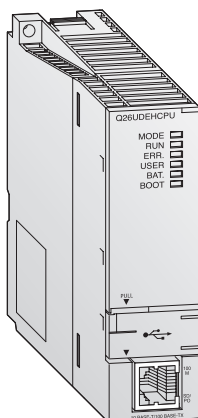

Universal PLC CPUs

These universal PLC CPUs are the latest generation of modular CPUs for the MELSEC System Q controller platform and they are the foundation of the iQ Platform system. They can be combined with the motion, robot and NC CPUs to configure scalable and highly flexible modular automation systems.

- Integrated mini USB interface for programming
- Integrated Ethernet interface for efficient communication with the Q□UDEH modules
- Extremely fast bit processing, 9.5 ns
- High-speed data access
- Q□UDVCPUs enable high speed program processing
- SD memory card and SRAM cassette installable in Q□UDVCPUS

Specifications	Q00UCPU	Q00UCPU	Q01UCPU	Q02UCPU	Q03UDCPU, Q03UDECPU
Type	Multi processor CPU module				
I/O points	256/8192	1024/8192	1024/8192	2048/8192	4096/8192
CPU self-diagnostic functions	CPU error detection, Watch Dog, battery error detection, memory error detection, program check, power supply error detection, fuse error detection				
Battery buffer	All CPU modules are fitted with a lithium-battery with a life expectancy of 5 years.				
Memory type	RAM, ROM, FLASH	RAM, ROM, FLASH	RAM, ROM, FLASH	RAM, ROM, FLASH	RAM, ROM, FLASH
Memory capacity for PLC program	10 k steps (40 kByte)	10 k steps (40 kByte)	15 k steps (60 kByte)	20 k steps (80 kByte)	30 k steps (120 kByte)
Program cycle period	120 ns/log. instruction	80 ns/log. instruction	60 ns/log. instruction	40 ns/log. instruction	20 ns/log. instruction
Dimensions (WxHxD) mm	245x98x98	27.4x98x89.3	27.4x98x89.3	27.4x98x89.3	27.4x98x89.3
Order information	Art. no. 221575	221576	221577	207604	207605, 217899

Specifications	Q04UDHCPU, Q04UDEHCPU	Q06UDHCPU, Q06UDEHCPU	Q10UDHCPU, Q10UDEHCPU	Q13UDHCPU, Q13UDEHCPU	Q20UDHCPU, Q20UDEHCPU	Q26UDHCPU, Q26UDEHCPU	Q50UDEHCPU *	Q100UDEHCPU *
Type	Multi processor CPU module							
I/O points	4096/8192	4096/8192	4096/8192	4096/8192	4096/8192	4096/8192	4096/8192	4096/8192
CPU self-diagnostic functions	CPU error detection, Watch Dog, battery error detection, memory error detection, program check, power supply error detection, fuse error detection							
Battery buffer	All CPU modules are fitted with a lithium-battery with a life expectancy of 5 years.							
Memory type	RAM, ROM, FLASH	RAM, ROM, FLASH	RAM, ROM, FLASH	RAM, ROM, FLASH	RAM, ROM, FLASH	RAM, ROM, FLASH	RAM, ROM, FLASH	RAM, ROM, FLASH
Memory capacity for PLC program	40 k steps (160 kByte)	60 k steps (240 kByte)	100 k steps (400 kByte)	130 k steps (520 kByte)	200 k steps (800 kByte)	260 k steps (1040 kByte)	500 k steps (2000 kByte)	1000 k steps (4000 kByte)
Program cycle period	9.5 ns/log. instruction	9.5 ns/log. instruction	9.5 ns/log. instruction	9.5 ns/log. instruction	9.5 ns/log. instruction	9.5 ns/log. instruction	9.5 ns/log. instruction	9.5 ns/log. instruction
Dimensions (WxHxD) mm	27.4x98x89.3	27.4x98x89.3	27.4x98x89.3	27.4x98x89.3	27.4x98x89.3	27.4x98x89.3	27.4x98x115	27.4x98x115
Order information	Art. no. 207606, 217900	207607, 215808	221578, 221579	217619, 217901	221580, 221581	217620, 217902	242368	242369

* is supported by GXWorks2 only

Specifications	Q03UDVCPU	Q04UDVCPU	Q06UDVCPU	Q13UDVCPU	Q26UDVCPU
Type	Multi processor CPU module				
I/O points	4096/8192				
CPU self-diagnostic functions	CPU error detection, Watch Dog, battery error detection, memory error detection, program check, power supply error detection, fuse error detection				
Battery buffer	All CPU modules are fitted with a lithium-battery with a life expectancy of 5 years.				
Memory type	RAM, ROM, FLASH, SD-Card, extended SRAM cassette				
Memory capacity for PLC program	30 k steps (120 kByte)	40 k steps (160 kByte)	60 k steps (240 kByte)	130 k steps (520 kByte)	260 k steps (1040 kByte)
Program cycle period	1.9 ns/log. instruction	1.9 ns/log. instruction	1.9 ns/log. instruction	1.9 ns/log. instruction	1.9 ns/log. instruction
Dimensions (WxHxD) mm	27.4x98x115	27.4x98x115	27.4x98x115	27.4x98x115	27.4x98x115
Order information	Art. no. 266161	266162	266163	266164	266165
Accessories	Q4MCA-1MBS; 1 MB memory cassette for Q□UDVCPU Q4MCA-2MBS; 2 MB memory cassette for Q□UDVCPU Q4MCA-4MBS; 3 MB memory cassette for Q□UDVCPU Q4MCA-8MBS; 4 MB memory cassette for Q□UDVCPU		Art. no. 266134; Art. no. 266155; Art. no. 266156 Art. no. 266157		

Process CPU modules

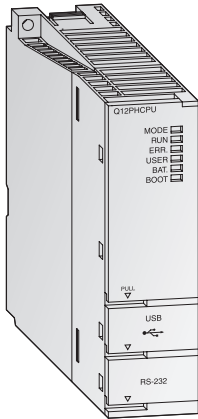

The MELSEC System Q process CPU allows flexible system design based on off-the-shelf components, which reduces both initial and implementation costs. Using either PX Developer/GX Developer or GX IEC Developer, process applications can be designed, debugged, monitored and maintained. The MELSEC Process Control system is best suited for food manufacturing and chemical plant applications, where liquid or solid materials are stored in a tank and a level must be maintained within a specific range. The Process CPU combines DCS functions with PLC operability into one compact module.

- Simplified control and engineering
- Extensive Loop control
- High-speed Loop control
- Improved reliability and serviceability
- Hot-swap module replacement in run mode
- Works with CC-Link IE, MELSECNET/H for multiplex remote I/O system
- Loop Control and sequence control with one CPU
- Utilisation and expandability
- Use with isolated analog modules, ideal for process control
- Smoothed analog input value

4

Modular PLCs

Specifications	Q02PHCPU	Q06PHCPU	Q12PHCPU	Q25PHCPU
Type	Process CPU module			
I/O points	4096/8192	4096/8192	4096/8192	4096/8192
CPU self-diagnostic functions	CPU error detection, Watch Dog, battery error detection, memory error detection, program check, power supply error detection, fuse error detection			
Battery buffer	All CPU modules are fitted with a lithium-battery with a life expectancy of 5 years.			
Memory type	RAM, ROM, FLASH	RAM, ROM, FLASH	RAM, ROM, FLASH	RAM, ROM, FLASH
Memory capacity	overall	≤32 MByte	≤32 MByte	≤32 MByte
	max. for PLC program	28 k steps (112 kByte)	60 k steps (240 kByte)	124 k steps (496 kByte)
Program cycle period	34 ns/log. instruction	34 ns/log. instruction	34 ns/log. instruction	34 ns/log. instruction
Dimensions (WxHxD)	mm 27.4x98x89.3	27.4x98x89.3	27.4x98x89.3	27.4x98x89.3
Order information	Art. no. 218138	218139	143529	143530

Redundant PLC CPU modules

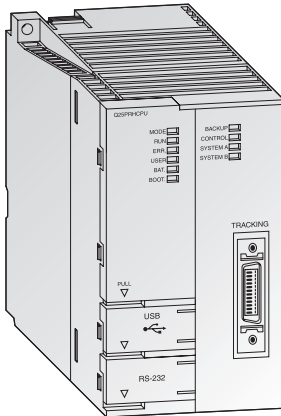

Two PLC systems with the same configuration can provide a hot standby system through automatic synchronisation of data. This is the key to a redundant system and high availability. Down time and costs for re-starting are also dramatically reduced. The higher hardware costs for a redundant system are negligible when compared to the reduced costs in case of an error.

If the control system fails, the standby system takes over without interruption of the process.

The modular concept allows different stages of redundancy: Redundant power supply, redundant control systems, redundant network modules.

- A redundant system with QnPRH consists mainly of standard components. Existing hardware can be used.
- Embedding is possible in existing and non redundant applications
- Short system switching time can be set by parameters (min. 22 ms, 48 k words)
- Can be programmed like a standard system, no special software required
- Automatic detection of the control system with MX-Components/MX-OPC Server.
- The I/O-level can be connected via MELSECNET/H network (redundant ring), CC-Link, CC-Link IE, Ethernet or Profibus. The availability of these networks can be increased by using redundant master modules.

Specifications	Q12PRHCPU	Q25PRHCPU
Type	Process CPU module, redundant	
I/O points	4096/8192	4096/8192
CPU self-diagnostic functions	CPU error detection, Watch Dog, battery error detection, memory error detection, program check, power supply error detection, data tracking	
Battery buffer	All CPU modules are fitted with a lithium-battery with a life expectancy of 5 years.	
Memory type	RAM, ROM, FLASH	RAM, ROM, FLASH
Memory capacity	overall	≤32 MByte
	max. for PLC program	124 k steps (496 kByte)
Program cycle period	34 ns/log. instruction	34 ns/log. instruction
Dimensions (WxHxD)	mm 52.2x98x89.3	52.2x98x89.3
Order information	Art. no. 157070	157071

Motion CPU modules

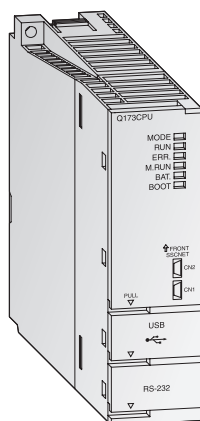

The high-speed dynamic motion CPU

The motion controller CPU controls and synchronises the connected servo amplifiers and servo motors. A motion system requires a motion controller CPU, and a PLC CPU.

In this configuration the Motion CPU controls large-scale servo movements and a PLC CPU or C Controller CPU is simultaneously responsible for the machine control and the communication.

- Using multiple CPU's to distribute the load improves the overall performance of the whole system
- Use of up to 3 motion CPU's within one system
- Large scale control system for up to 96 axes per system
- Interpolation of 4 axes simultaneously
- Software cam control
- Virtual and real master axes
- Integration in the high-speed SSCNETIII network for communication with high-performance servo amplifiers at up to 50 Mbps

Specifications	Q172DCPU	Q172HCPU	Q173DCPU	Q173HCPU
Type	Motion CPU			
I/O points	8192; 8	8192; 8	8192; 32	8192; 32
Interpolation functions	Linear interpolation for up to 4 axes, circular interpolation for 2 axes, helical interpolation for 3 axes			
Programming language	Motion SFC, dedicated instructions, software for conveyor assembly (SV13), virtual mechanical support language (SV22)			
Interfaces	SSCNETIII (USB, RS232C via PLC CPU)	USB, RS232C, SSCNETIII	SSCNETIII (USB, RS232C via PLC CPU)	USB, RS232C, SSCNETIII
Real I/O points (PX/PY)	256 (these I/Os can be allocated directly to the motion CPU)			
Dimensions (WxHxD)	mm 27.4x98x119.3	27.4x98x114.3	27.4x98x119.3	27.4x98x114.3
Order information	Art. no. 209788	162417	209787	162416

Q-C Controller CPU

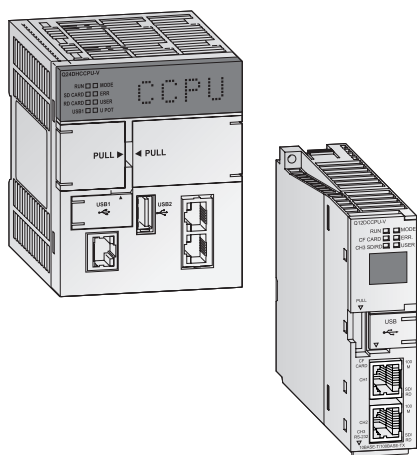

High-level language programming in combination with real time operating system

The C Controller allow the integration and programming of the MELSEC System Q automation platform with C++. Using the worldwide established real time operating system VxWorks, the realisation of complex tasks, communication and protocols becomes very easy.

- Integration in a multi CPU – MELSEC System Q or use as a stand alone system.
- Dedicated development environment of C-/C++ language
- CompactFlash card makes handling for large quantities of data easy
- High performance addition to the existing range of automation products
- 7-segment LED display for efficient debugging and troubleshooting (Q12CCPU-V only)
- Ethernet and RS232 interface on board
- Q12DCCPU-V with additional USB interface
- Real time OS VxWorks and Telnet pre-installed
- Standard C/C++ Code can be embedded
- Remote access via networks and support of FTP
- VxWorks communication library and QBF libraries for easy setup
- CODESYS compatibility

Specifications	Q24DHCCPU-V	Q12DCCPU-V
Memory	Standard ROM: 382 MB; Work RAM: 512 MB; Battery-backed-up RAM: 5 MB	Standard RAM: 3 MB; Work RAM: 128 MB; Battery-backed-up RAM: 128 kB
Operating system	VxWorks Version 6.8.1	VxWorks Version 6.4 (preinstalled)
Programming language	C or C++	
Development tool	Workbench 3.2	Workbench 2.6.1
Communication interfaces	10BASE-T/100BASE-TX (2 ch.), USB (1 ch.)	RS232 (1 ch.), 10BASE-T/100BASE-TX (2 ch.), USB (1 ch.)
CF card I/F	1 slot for a TYPE I card (Max. 1 GB CF card is supported.)	1 slot for a TYPE I card (Max. 8 GB CF card is supported.)
Number of I/O points	4096 (X/YO to FFF)	
5 V DC internal current consumption	A 2.8	0.93
Dimensions (WxHxD)	mm 83x98x115	27.4x98x115
Order information	Art. no. 260296	221295

iQ Platform CPUs

Robot CPU (see Robots chapter)

NC CPU (please contact your nearest Mitsubishi Electric distributor for more details)

PC CPU Module

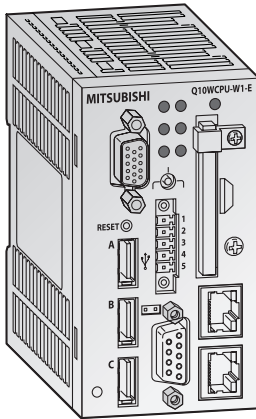

The Windows®-CPU

The Q10WCPU uses the Microsoft Windows® operating system and can be combined with the power supplies, racks, I/O and special modules from the MELSEC System Q. The CPU module can be used in stand-alone mode or in multi-CPU mode, in conjunction with PLC CPU modules for example. This enables a seamless connection between the process and the data processing system. While the PLC CPU modules control and regulate processes, the Q10WCPU undertakes the conditioning and processing of data. The Q10WCPU-W1-E boots up from the integral solid-state drive (SSD) or from an installed Type 1 CF memory card (Q10WCPU-W1-CFE). The two integral LAN interfaces allow the unit to be incorporated in networks and enable access to Intranet and Internet. The hardware has been implemented by means of an embedded CPU and a proven chipset. The use of easily available components ensures that this CPU module can be applied with ease. In addition, the self-adapting BIOS enables support right at the BIOS level.

- Windows® operating system in a module with small dimensions (double the width of a MELSEC System Q PLC CPU module).
- Energy-saving by using an Intel Atom N450 processor. Various options for saving energy are adjustable. This ensures adequate performance and low energy consumption.
- Equipped with a variety of interfaces as standard (1000BASE-T (LAN), USB 2.0, CF-Card etc.).
- The customizable Phoenix Award BIOS enables support right at the BIOS level.
- A CF memory card can be installed as an external storage medium (Q10WCPU-W1-CFE)
- The integrated Solid State Drive (SSD) has a double write protection function and thus provides a reliable protection for important data.

Specifications	Q10WCPU-W1-E	Q10WCPU-W1-CFE
Type	Personal Computer CPU	
CPU	Intel® Atom™ Processor N450 1.66 GHz	
Chip set	Intel® ICH8M	
Processing frequency	GHz 1.66	
Memory	L1 cache	Instruction 32 kB + data 24 kB
	L2 cache	512 kB
	Main	1 GB
Video	Analog-RGB, resolution 1400 x 1050 at 60 Hz (16 million colors)	
Interfaces	Serial (RS232C)	One 9-pin D-SUB connector, transfer rate: 50–115200 bps
	USB	Five USB2.0 compliant ports (3 at the front and 2 at the rear)
	Keyboard/mouse	Connection via one of the USB ports
	LAN	Two RJ45 sockets for 1000BASE-T/100BASE-TX/10BASE-T
	Monitor	1x15-pin H-DSUB
PC card slots	1 slot for CF memory card (type I)	
Internal power consumption (5 V DC)	A	Max. 3
Weight	kg	0.44
Dimensions (WxHxD)	mm	55.2x98.0x115
Order information	Art. no.	252826
		252827

Digital input modules

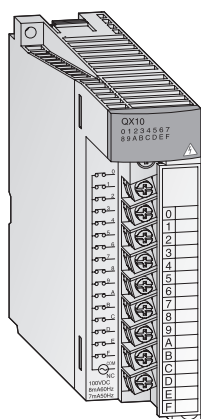

Input module – Detection of process signals

Various input modules are available for converting digital process signals with different voltage levels into the levels required by the PLC.

- Potential isolation between process and control by means of an optocoupler is a standard feature
- Indication of input status via LED

- Modules with 16 connection points have removable terminal blocks with screws
- Modules with 32/64 connection points are connected with a D-Sub or 40-pin plug
- Assembled cables are available for modules with D-Sub plugs

Input modules

Specifications	QX10	QX10-TS	QX28	QX40	QX40-TS	QX41	QX42
Input points	16	16	8	16	16	32	64
Rated input voltage	100–120 V AC (50/60 Hz)	100–120 V AC (50/60 Hz)	100–240 V AC (50/60 Hz)	24 V DC	24 V DC	24 V DC	24 V DC
Operating voltage range	V 85–132	85–132	85–264	20.4–28.8	20.4–28.8	20.4–28.8	20.4–28.8
Rated input current	mA 7 (100 V AC, 50 Hz), 8 (100 V AC, 60 Hz)	8 (100 V AC, 60 Hz), 7 (100 V AC, 50 Hz)	7 (100 V AC, 50 Hz), 8 (100 V AC, 60 Hz), 14 (200 V AC, 50 Hz), 17 (200 V AC, 60 Hz)	ca. 4	ca. 4	ca. 4	ca. 4
ON	voltage V \geq AC 80	\geq AC 80	\geq AC 80	\geq DC 19	\geq DC 19	\geq DC 19	\geq DC 19
	current mA \geq AC 5	\geq AC 5	\geq AC 5	\geq DC 3	\geq DC 3	\geq DC 3	\geq DC 3
OFF	voltage V \leq AC 30	\leq AC 30	\leq AC 30	\leq DC 11	\leq DC 11	\leq DC 11	\leq DC 11
	current mA \leq AC 1	\leq AC 1.7	\leq AC 1	\leq DC 1.7	\leq DC 1.7	\leq DC 1.7	\leq DC 1.7
Load resistance	k Ω Ca. 18 (50 Hz) ca. 15 (60 Hz)	ca. 12 (60 Hz) ca. 15 (50 Hz)	ca. 15 (50 Hz) ca. 12 (60 Hz)	ca. 5.6	—	ca. 5.6	ca. 5.6
Common terminal arrangement	16	16	8	16	16	32	32
Connection terminal	18-point removable terminal block	Removable terminal block with spring terminals	18-point removable terminal block	18-point removable terminal block	Removable terminal block with spring terminals	40-pin connector	40-pin connector x 2
No. of occupied I/O points	16	16	16	16	16	32	64
Dimensions (WxHxD)	mm 27.4x98x90	27.4x98x90	27.4x98x90	27.4x98x90	27.4x98x90	27.4x98x90	27.4x98x90
Order information	Art. no. 129581	221838	136396	132572	221839	132573	132574

Specifications	QX50	QX80	QX80-TS	QX81	QX82-51
Input points	16	16	16	32	64
Rated input voltage	48 V DC	24 V DC	24 V DC	24 V DC	24 V DC
Operating voltage range	V 40.8–52.8	20.4–28.8	20.4–28.8	20.4–28.8	20.4–28.8
Rated input current	mA Ca. 4	ca. 4	ca. 4	ca. 4	ca. 4
ON	voltage V \geq DC 28	\geq DC 19	\geq DC 19	\geq DC 19	\geq DC 19
	current mA \geq DC 2.5	\geq DC 3	\geq DC 3	\geq DC 3	\geq DC 3
OFF	voltage V \leq DC 10	\leq DC 11	\leq DC 11	\leq DC 11	\leq DC 9.5
	current mA \leq DC 1.7	\leq DC 1.7	\leq DC 1.7	\leq DC 1.7	\leq DC 1.5
Load resistance	k Ω Ca. 11.2	ca. 5.6	—	ca. 5.6	ca. 5.6
Common terminal arrangement	16	16	16	32	32x2
Connection terminal	18-point removable terminal block	18-point removable terminal block	Removable terminal block with spring terminals	Compact connector 37-pin D-Sub	40-pin connector x 2
No. of occupied I/O points	16	16	16	32	64
Dimensions (WxHxD)	mm 27.4x98x90	27.4x98x90	27.4x98x90	27.4x98x90	27.4x98x90
Order information	Art. no. 204678	127587	221840	129594	150837

Digital output modules

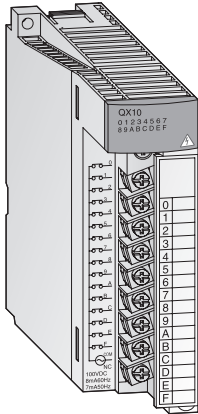

Output module – Adapted output technology

The MELSEC System Q output modules have different switching elements for adaptation to many control tasks.

- Output modules with relay, transistor or triac switches
- Potential isolation between process and control by means of an optocoupler is a standard feature
- Modules with potential isolation between the channels

- Modules with 16 connection points have removable terminal blocks with screws
- Modules with 32/64 connection points are connected with a D-Sub or 40-pin plug
- Assembled cables are available for modules with D-Sub plugs

Output modules

Specifications	QY10	QY10-TS	QY18A	QY22	QY40P	QY40P-TS	QY41P	QY42P	
Outputs	16	16	8	16	16	16	32	64	
Output type	Relay	Relay	Relay	Triac	Transistor (sink type)	Transistor (sink type)	Transistor (sink type)	Transistor (sink type)	
Common terminal arrangement	16 points	16	8	16	16	16	32	32	
Rated output voltage	24 V DC /240 V AC	24 V DC /240 V AC	24 V DC /240 V AC	100–240 V AC	12/24 V DC (sink type)	12/24 V DC (sink type)	12/24 V DC (sink type)	12/24 V DC (sink type)	
Operating voltage range	—	—	—	—	10.2–28.8 V DC	10.2–28.8 V DC	10.2–28.8 V DC	10.2–28.8 V DC	
Connection terminal	18-point removable terminal block	Removable terminal block with spring terminals	18-point removable terminal block	—	—	Removable terminal block with spring terminals	40-pin connector	40-pin connector x 2	
No. of occupied I/O points	16	16	16	16	16	16	32	64	
Ext. power supply req.	—	—	—	—	12–24 V DC	12–24 V DC	12–24 V DC	12–24 V DC	
voltage	—	—	—	—	10 (24 V DC)	10 (24 V DC)	20 (24 V DC)	20 (24 V DC)	
current	—	—	—	—	10 (24 V DC)	10 (24 V DC)	20 (24 V DC)	20 (24 V DC)	
Dimensions (WxHxD)	mm	27.4x98x90	27.4x98x90	27.4x98x90	27.4x98x90	27.4x98x90	27.4x98x90	27.4x98x90	
Order information	Art. no.	129605	221841	136401	136402	132575	221842	132576	132577
Accessories	40-pin connector and ready to use connection cables and system terminals; Spring clamp terminal block for exchange against the standard screw terminal block; IDC terminal block adapter for all 32 point I/O modules with 40-pin connector								

Specifications	QY50	QY68A	QY80	QY80-TS	QY81P	QY82P	
Outputs	16	8	16	16	32	64	
Output type	Transistor (sink type)	Transistor (sink/source type)	Transistor (source type)	Transistor (source type)	Transistor (source type)	Transistor (source type)	
Common terminal arrangement	16 points	All independent	16	16	32	32	
Rated output voltage	12/24 V DC	5–24 V DC	12/24 V DC	12/24 V DC	12/24 V DC	12/24 V DC	
Operating voltage range	10.2–28.8 V DC	4.5–28.8 V DC	10.2–28.8 V DC	10.2–28.8 V DC	10.2–28.8 V DC	10.2–28.8 V DC	
Connection terminal	18-point removable terminal block	18-point removable terminal block	18-point removable terminal block	Removable terminal block with spring terminals	Compact connector 37-pin D-Sub	40-pin connector x 2	
No. of occupied I/O points	16	16	16	16	32	64	
Ext. power supply req.	12–24 V DC	—	12–24 V DC	12–24 V DC	12–24 V DC	12–24 V DC	
voltage	20 (24 V DC)	—	20 (24 V DC)	20 (24 V DC)	40 (24 V DC)	20 (24 V DC)	
current	20 (24 V DC)	—	20 (24 V DC)	20 (24 V DC)	40 (24 V DC)	20 (24 V DC)	
Dimensions (WxHxD)	mm	27.4x98x90	27.4x98x90	27.4x98x90	27.4x98x90	27.4x98x90	
Order information	Art. no.	132578	136403	127588	221843	129607	242366
Accessories	40-pin connector and ready to use connection cables and system terminals; Spring clamp terminal block for exchange against the standard screw terminal block; IDC terminal block adapter for all 32 point I/O modules with 40-pin connector						

NAMUR input module

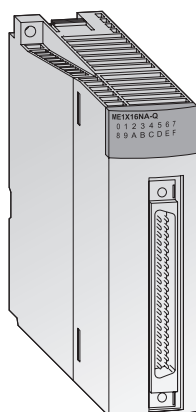

The ME1X16NA-Q is a digital input module for connection of up to 16 NAMUR sensors.

In contrast to an ordinary binary sensor with only two states (ON and OFF), a NAMUR sensor can indicate four states: ON, OFF, wire break and short circuit.

As an alternative to NAMUR sensors, contacts with an external resistor network can be used.

The ME1X16NA-Q can also monitor the sensor status (switched ON, switched OFF, wire break, short circuit, fluttering signal), and store the historical data of occurred events into an internal buffer.

- Input signal conditioning: short pulse discrimination (0–2 s), pulse stretching (0–2 s)
- Fault detection: short circuit detection, wire break detection, flutter detection
- Time stamping: trigger on input signal change, trigger on fault detection, time resolution 1 ms, buffer for 64 events with time information

Specifications		ME1X16NA-Q
Number of NAMUR inputs		16
Sensor voltage (from internal power supply)	V DC	8.2
ON current	mA	>2.1
OFF current	mA	<1.2
Hysteresis	mA	0.2
Wire break detection current	mA	<0.2
Short circuit detection current	mA	>7.5
Maximum short circuit current	mA	8.9
Response time	OFF to ON ON to OFF	3 ms/6 ms or less (configured in PLC parameter) (Default: 6 ms)
Time stamping	Resolution	ms 1
No. of occupied I/O points		32
Connection terminal		40-pin connector
Dimensions (WxHxD)	mm	27.4x98x90
Order information	Art. no.	257846
Accessories		40-pin connector and ready to use connection cables and system terminals; Spring clamp terminal block for exchange against the standard screw terminal block; IDC terminal block adapter for all 32 point I/O modules with 40-pin connector

Analog input modules

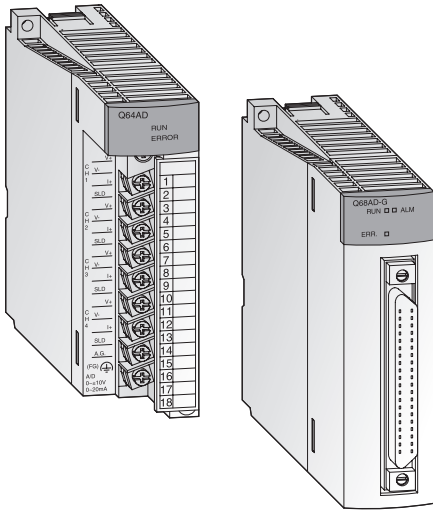

Detection of analog process signals

The analog input modules convert analog process signals, for example pressure, flow or fill level, linearly into digital values, which are further processed by the Q CPU.

- Up to 8 channels per module (Q68AD□) and up to 512 channels per system (Q CPU)
- Calculation of average value over the time or measurement cycles can be configured
- Q64ADH has build-in logging function
- Flow amount integration function (Q64ADH only)
- Potential isolation between process and control by means of an optocoupler is a standard feature

Channel isolated and high resolution

The analog input modules Q62AD-DGH, Q64AD-GH, Q66AD-DG and Q68AD-G convert analog process signals into digital values with high accuracy. All channels are isolated between each other and against the external power supply with high dielectric withstand voltage for both. This eliminates the need for external isolation amplifiers.

The Q66AD-DG additionally features the embedded signal conditioning function, so that signal converters for 2-wire transmitters are not needed.

- Reduced cost for analog I/O that require channel isolation
- Less space and wiring in the control panel required

HART compatible

The functionality of a HART Master station is integrated in the ME1AD8HAI-Q. It can communicate with up to 8 HART compatible devices.

Input modules

Specifications	Q62AD-DGH	Q64AD	Q64ADH	Q64AD-GH	Q66AD-DG	Q68AD-G	Q68ADV	Q68ADI	ME1AD8HAI-Q	
Input points	2	4	4	4	6	8	8	8	8	
Analog input	voltage V	—	-10V~+10	-10~+10	-10V~+10	—	-10~+10	-10~+10	—	0~+4
	current mA	4~20	0~20	0~20	0~20	0~20/4~20	0~20	—	0~20	0~20
Resolution	16/32 bits binary (incl. sign)	16 bits binary (incl. sign)	16 bits binary (incl. sign)	16 bits binary (incl. sign)	16 bits binary (incl. sign)	16 bits binary (incl. sign)	16 bits binary (incl. sign)	16 bits binary (incl. sign)	16 bits binary (incl. sign)	16 bits signed binary
Load resistance	voltage MΩ	—	1	1	1	—	1	1	—	—
	current Ω	250	250	250	250	250	250	250	250	250
Max. input	voltage V	—	±15	±15	±15	—	±15	±15	—	—
	current mA	±30	±30	±30	±30	±30	±30	±30	±30	±30
I/O characteristics	analog input	0~20 mA	-10~+10 V; 0~20 mA	-10~+10 V; 0~20 mA	-10~+10 V; 0~20 mA	0~20 mA	-10~+10 V; 0~20 mA	-10~+10 V	0~20 mA	0~20 mA; 4~20 mA
	digital output	1/32000, 1/64000	1/4000, 1/12000, 1/16000; 1/4000, 1/8000, 1/12000	1/12000, 1/22500	±1/32000, ±1/64000; 1/32000, 1/64000	1/4000, 1/12000	±1/4000; ±1/12000, ±1/16000	1/4000, 1/12000, 1/16000	1/4000, 1/8000, 1/12000	1/32000
Max. resolution	voltage input	—	0.83 mV	200 μV	62.5 μV	—	0.333 mV	1 mV	—	—
	current input	0.25 μA	3.33 μA	800 nA	0.25 μA	1.33 μA	1.33 μA	—	0~20 mA/4~20 mA	625 nA/ 500 nA
Overall accuracy	±0.05 %	±0.4 % (0~55 °C), ±0.1 % (20~30 °C)	±0.2 % (0~55 °C), ±0.1 % (20~30 °C)	±0.05 %	±0.1 %	±0.1 %	±0.4 % (0~55 °C), ±0.1 % (20~30 °C)	±0.4 % (0~55 °C), ±0.1 % (20~30 °C)	±0.15 %	
Max. conversion time	10 ms/ 2 channels	80 μs/channel (+160 μs with temperature drift compensation)	10 ms/ 4 channels	10 ms/ 4 channels	10 ms/channel	10 ms/channel	80 μs/channel (+160 μs with temperature drift compensation)	80 μs/channel (+160 μs with temperature drift compensation)	—	
Connection terminal	18-point removable terminal block			18-point removable terminal block	40-pin connector	40-pin connector	18-point remov- able terminal block	18-point remov- able terminal block	18-point remov- able terminal block	
I/O points	16	16	16	16	16	16	16	16	32	
Dimensions (WxHxD)	mm	27.4x98x90	27.4x98x90	27.4x98x90	27.4x98x90	27.4x98x90	27.4x98x90	27.4x98x90	27.4x98x90	
Order information	Art. no.	145036	129615	251331	143542	204676	204675	129616	129617	229238

Analog output modules

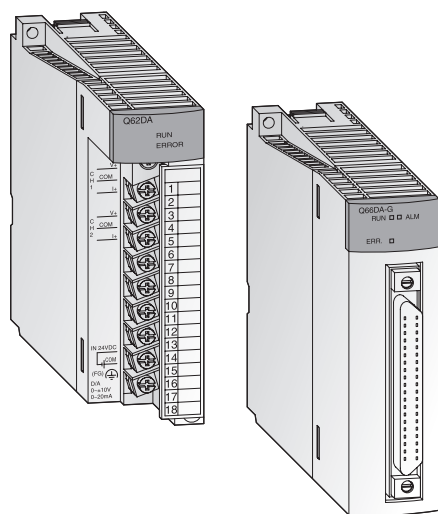

Output of analog control signals

The analog output modules convert digital values predetermined by the CPU into analog current or voltage signal. For example, frequency inverters, valves or slide valves are controlled by means of these signals.

- Up to 8 channels per module (Q68DA□) and up to 512 channels per system
- Resolution of 0.333 mV and 0.83 μA
- Conversion time of 80 μs/channel
- Potential isolation between process and control by means of an optocoupler is a standard feature

Channel isolated and high resolution

The analog output module Q66DA-G converts a digital value into an analog voltage or current signal with high accuracy. All channels are isolated between each other and against the external power supply with high dielectric withstand voltage for both. This eliminates the need for external isolation amplifiers.

- Reduced cost for analog I/O that require channel isolation
- Less space and wiring in the control panel required

DA modules with isolated external power supply

The new analog output modules Q62DAN, Q64DAN, Q68DAVN and Q68DAIN isolate the analog output channel from the external power supply to ensure, that any power fluctuations caused by external noise do not disrupt the analog output.

- Improved noise resistance
- Improved safety on the strength of short circuit protection caused by incorrect wiring

HART compatible

The functionality of a HART Master station is integrated in the ME1DA6HAI-Q. It can communicate with up to 6 HART compatible devices.

Output modules

Specifications	Q62DAN	Q62DA-FG	Q64DAN	Q66DA-G	Q68DAVN	Q68DAIN	ME1DA6HAI-Q	
Output points	2	2	4	6	8	8	6	
Digital input	-16384—+16383	-16384—+16383	-16384—+16383	-16384—+16383	-16384—+16383	-16384—+16383	-32768—+32767	
Analog output	-10 V DC—+10 V DC (0 mA—+20 mA DC)	-10 V DC—+10 V DC (0 mA—+20 mA DC)	-10 V DC—+10 V DC (0 mA—+20 mA DC)	-12 V DC—+12 V DC (0 mA—+22 mA DC)	-10 V DC—+10 V DC	0 mA—+20 mA DC	0/4 mA—+20 mA DC	
Load resistance	voltage output	1 kΩ—1 MΩ	1 kΩ—1 MΩ	1 kΩ—1 MΩ	1 kΩ—1 MΩ	—	—	
	current output	0—600 Ω	0—600 Ω	0—600 Ω	0—600 Ω	—	50—600 Ω	
Max. output	voltage V	±12	±13	±12	±13	±12	—	
	current mA	21	23	21	23	—	21	
I/O characteristics	analog output	-10—+10 V; 0—20 mA	-10—+10 V; 0—20 mA	-10—+10 V; 0—20 mA	-10—+10 V; 0—20 mA	-10—+10 V	0—20 mA	
	digital input	±1/4000; ±1/12000, ±1/16000	±1/4000; ±1/12000, ±1/16000	±1/4000; ±1/12000, ±1/16000	±1/4000; ±1/12000, ±1/16000	±1/4000; ±1/12000, ±1/16000	±1/4000; ±1/12000, ±1/16000	1/28000
Maximum resolution	voltage output	0.333 mV	0.183 mV	0.333 mV	0.210 mV	0.333 mV	—	
	current output	0.83 μA	0.671 μA	0.83 μA	0.95 μA	—	0.83 μA	
Overall accuracy	±0.1 %	±0.1 %	±0.1 %	±0.1 %	±0.1 %	±0.1 %	0.15 %	
Max. conversion time	80 μs/channel	10 ms/2 channels	80 μs/channel	6 ms/channel	80 μs/channel	80 μs/channel	70 ms	
Connection terminal	18-point removable terminal block	18-point removable terminal block	18-point removable terminal block	40-pin connector	18-point removable terminal block	18-point removable terminal block	18-point removable terminal block	
I/O points	16	16	16	16	16	16	32	
Dimensions (WxHxD)	mm	27.4x98x90	27.4x98x90	27.4x98x90	27.4x98x90	27.4x98x90	27.4x98x90	
Order information	Art. no.	200689	145037	200690	204677	200691	200692	236649

Combined analog input/output module

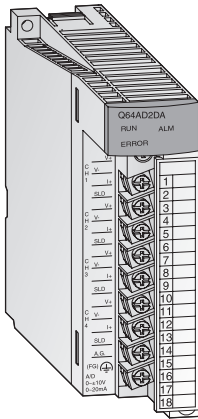

Q64AD2DA

With the analog input/output module Q64AD2DA the user has a module that has both, four analog inputs and two analog outputs. Selection of current or voltage input signal is possible for the analog inputs.

- Detection and output of voltage and current with one module.
- Detection of analog signals with either standard or high resolution

Specifications		Q64AD2DA
Input points		4
Analog input	voltage	V -10--+10
	current	mA 0--+20
Load resistance	voltage	MΩ 1
	current	Ω 250
Max. input	voltage	V ±15
	current	mA ±30
I/O characteristics	analog input	-10--+10 V; 0-20 mA
	digital output	±1/4000, ±1/16000; ±1/4000, ±1/12000
Max. resolution	voltage input	0.333 mV
	current input	0.83 μA
Accuracy		±0.4 % (0-55 °C), ±0.1 % (20-30 °C)
Max. conversion time		500 μs/channel
Output points		2
Digital input		-16384--+16383
Analog output	voltage	V -10--+10
	current	mA 0--+20
Load resistance	voltage output	1 kΩ-1 MΩ
	current output	0-600 Ω
Max. output	voltage	V ±12
	current	mA 21
I/O characteristics	analog output	-10--+10 V; 0-20 mA
	digital input	±1/4000, ±1/16000; ±1/4000, ±1/12000;
Max. resolution	voltage output	0.333 mV
	current output	1.33 μA
Accuracy		±0.3 % (0-55 °C), ±0.1 % (20-30 °C)
Max. conversion time		500 μs/channel
Connection terminal		18-point removable terminal block
I/O points		16
Dimensions (WxHxD)	mm	27.4x98x90
Order information	Art. no.	229238

Analog CT Input Module

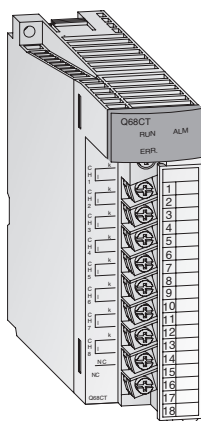

Current transformer module

Up to eight current transformers can be connected directly to the analog CT input module Q68CT. External signal converters are not required anymore.

- CT sensors from 5 A AC to 600 A AC are connectable.
- High accuracy within $\pm 0.5\%$
- Averaging calculation
- Maximum value/minimum value hold function

- Integrated scaling function
- Input signal monitoring with alarm output
- Peak current detection
- Integrated logging function

Specifications	Q68CT
Input points	8
Analog input (via CT sensor)	5/50/100/200/400/600 A AC
Input frequency	50/60 Hz
Excessive input	200 % for 1 minute, 150 % continuously
Digital output	Converted current value
	Scaling value
Max. resolution	0–5 A AC : 0.5 mA
	0–50 A AC : 5 mA
	0–100 A AC : 10 mA
	0–200 A AC : 20 mA
	0–400 A AC : 40 mA
0–600 A AC : 60 mA	
Overall accuracy	$\pm 0.5\%$
Minimum sampling cycle	10 ms/8 channels
Response time	Max. 0.4 s
Insulation method	Between input terminals and power supply: transformer. Between input channels: no isolation
I/O points	16
Connection terminal	18-point removable terminal block with screws
Applicable wire size	mm ² 0.3–0.75
Internal power consumption (5 V DC)	mA 350
Weight	kg 0.19
Dimensions (WxHxD)	mm 27.4x98x112
Order information	Art. no 145036

Analog modules for temperature measurement

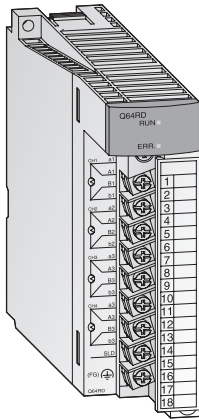

Temperature measurement by thermocouple

These modules are designed to convert external platinum temperature-measuring resistor input values into 16 or 32-bit signed binary temperature measurement values and scaling values.

The temperature is determined by means of a thermocouple for the Q64TD, Q64TDV-GH and Q68TD-G-H01/H02

- Temperature of 8 channels can be measured by one module
- Two kinds of platinum temperature measuring resistors (Pt100, JPt100) compliant with JIS and IEC standards are supported
- The disconnection of a platinum temperature-measuring resistor or cable can be detected on each channel

- Selection of sampling processing/time averaging processing/count averaging processing
- Error compensation by offset/gain value setting
- Alarm output when limit value is exceeded
- Potential isolation between process and control by means of an optocoupler is a standard feature. Additional potential isolation between the channels for the Q64TDV-GH
- The module is provided with a removable terminal block fastened with screws

Specifications	Q64RD	Q64RD-G	Q64TD	Q64TDV-GH	Q68RD3-G	Q68TD-G-H01/H02
Input channels	4	4	4	4	8	8
Connectable thermocouple type	Pt100 (conf. JIS C 1604-1989 and DIN IEC 751), JPt100 (conforms to JIS C 1604-1981)	Pt100 (conf. JIS C 1604-1997 and DIN IEC 751-1983), JPt100 (conf. to JIS C 1604-1981), Ni100Ω (conf. to DIN 43760-1987)	K, E, J, T, B, R, S, N (conf. to JIS C1602-1995, IEC 584-1 and 584-2)	K, E, J, T, B, R, S, N (conf. to JIS C1602-1995, IEC 584-1 and 584-2)	Pt100 (conf. JIS C 1604-1997 and DIN IEC 751), JPt100 (conf. to JIS C 1604-1981), Ni100Ω (conf. to DIN 43760-1987)	K, E, J, T, B, R, S, N (conf. to JIS C1602-1995, IEC 584-1 and 584-2)
Temperature measuring range	Pt100: -200–850 °C, JPt 100: -180–600 °C	Pt100: -200–850 °C, JPt 100: -180–600 °C, Ni100Ω: -60–180 °C	Depends on the thermocouple used	Depends on the thermocouple used	Pt100: -200–850 °C, JPt 100: -180–600 °C, Ni100Ω: -60–180 °C	Depends on the thermocouple used
Temperature scaling value	16-bit, signed binary: -2000–+8500 32-bit, signed binary: -200 000–+850 000	16-bit, signed binary: -2000–+8500 32-bit, signed binary: -200 000–+850 000	16-bit, signed binary: -2700–+18 200 32-bit, signed binary: —	16-bit, signed binary: -25 000–+25 000 32-bit, signed binary: —	16-bit, signed binary: -2000–+8500	16-bit, signed binary: -2700–+18200
Max. resolution	0.025 °C	0.025 °C	B, R, S, N: 0.3 °C; K, E, J, T: 0.1 °C	B: 0.7 °C; R, S: 0.8 °C, K, T: 0.3 °C; ET: 0.2 °C; J: 0.1 °C; N: 0.4 °C; Voltage: 4 μV	0.1 °C	B, R, S, N: 0.3 °C; K, E, J, T: 0.1 °C
Cold junction temp. compensation accuracy	—	—	±1.0 °C	±1.0 °C	—	provided
Max. conversion time	40 ms/channel	40 ms per channel	20 ms/channel	20 ms/channel	320 ms/8 channels	320 ms/8 channels (H01), 640 ms/8 channels (H02)
Analog inputs	4 channels/module	4 channels/module	4 channels/module + Pt100 connection	4 channels/module + Pt100 connection	8 channels	8 channels/module
Connection terminal	All modules are fitted with a removable terminal block with 18 screw terminals.				A6CON 40pin connector	
Channel isolation	—	provided	—	provided	provided	provided
Dimensions (WxHxD) mm	27.4x98x90	27.4x98x112	27.4x98x90	27.4x98x90	27.4x102x130	27.4x98x90 (H01) 27.4x102x130 (H02)
Order information	Art. no. 137592	154749	137591	143544	216482	216481/221582

Temperature control modules

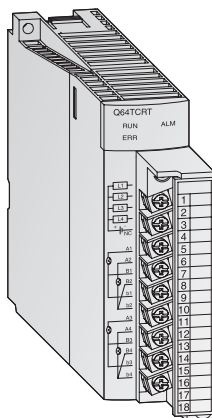

Temperature control modules with PID algorithm

These modules enable PID algorithm temperature control without placing any load on the PLC CPU for the temperature control tasks.

- Four temperature input channels
- Auto-tuning function for the 4 PID control circuits

- Temperature control can continue even when the PLC program is stopped
- Transistor output with pulse train to drive the actuator in the control circuit
- The module is provided with a removable terminal block fastened with screws.

Specifications		Q64TCRTN	Q64TCRTBWN	Q64TCTTN	Q64TCTTBWN
Control output	type	Transistor	Transistor	Transistor	Transistor
Inputs		4 channels per module	4 channels per module/broken wire detection	4 channels per module	4 channels per module/broken wire detection
Supported temperature sensors		Pt100 (-200~+600 °C), JPt100 (-200~+500 °C)		R, K, J, T, S, B, E, N, U, L, P L II, W5Re/W26Re	
Sampling cycle		0.5 s/4 channels	0.5 s/4 channels	0.5 s/4 channels	0.5 s/4 channels
Control output cycle	s	1-100	1-100	1-100	1-100
Input filter		1-100 s (0 s: input filter OFF)			
Temperature control method		PID ON/OFF impulse or 2-position control		PID ON/OFF impulse or 2-position control	
Target value setting range		Within the temperature range of the Pt100		Within the temperature range of the thermocouple used	
Dead band setting range		0.1-10.0 %	0.1-10.0 %	0.1-10.0 %	0.1-10.0 %
Insulation method		Transformer	Transformer	Transformer	Transformer
I/O points		16/1 slot	32/2 slots	16/1 slot	32/2 slots
Connection terminals		All modules are fitted with a terminal block with 18 screw terminals.			
Applicable wire size	mm ²	0.3-0.75	0.3-0.75	0.3-0.75	0.3-0.75
Internal power consumption (5 V DC)	mA	290	330	290	330
Dimensions (WxHxD)	mm	27.4x98x90	27.4x98x90	27.4x98x90	27.4x98x90
Order information	Art. no.	255456	255458	255455	255457

Load cell input module

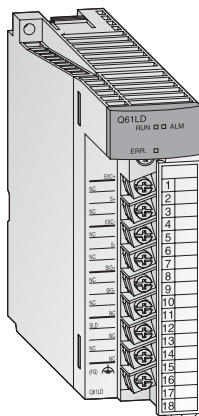

The load cell input module Q61LD can connect load cells directly to MELSEC System Q programmable controllers. External signal converters are no longer required.

- An external signal converter is not required. Man-hours and costs are reduced by using a load cell input module that can be connected directly to a programmable controller.

- The module achieves a highly accurate measurement with steady data conversion speed that guarantees the accuracy of load cells.
- Enhanced convenience with functions like zero offset, two-point calibration and input signal error detection.

Specifications		Q61LD
Analog input (load cell output) points		1
Analog input (load cell output)	mV/V	0.0-3.3
Analog input range (load cell rated output)	mV/V	0.0-1.0 0.0-2.0 0.0-3.0
Load cell applied voltage		5 V DC \pm 5 %, Output current within 60 mA (Four 350 W load cells can be connected in parallel.) 6-wire system (Combination use of remote sensing method and ratiometric method)
Digital output		32-bit signed binary, 0-10 000
Gross weight output (Max. weighing output value)		32-bit signed binary, -99999-99999 (Excluding decimal point and unit symbol)
Zero adjustment range	mV/V	0.0-3.0
Gain adjustment range	mV/V	0.3-3.2
Resolution		0-10 000
Accuracy		Nonlinearity: within \pm 0.01 %/FS (Ambient temperature: 25 °C)
Conversion speed	ms	10
Insulation method		Photocoupler insulation
Number of occupied I/O points		16
External connection system		18-point removable terminal block
Applicable wire size	mm ²	0.3-0.75
Internal power consumption (5 V DC)	A	0.48
Dimensions (WxHxD)	mm	27.4x98x90
Order information	Art. no.	229237

Loop control module

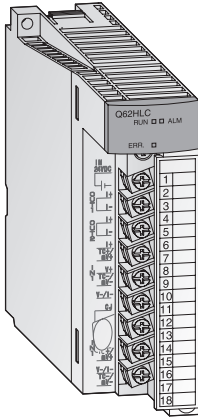

For fast response control

The Q62HLC loop control module uses a continuous proportional PID control format, which features a sampling period of 25 ms for high-accuracy, high-resolution thermocouple inputs, microvoltage inputs, voltage inputs, current inputs, and current outputs. These features make the Q62HLC ideal for applications such as rapid temperature increase control, pressure control, and flow rate control.

- 25 ms sampling and control update time makes the Q62HLC to one of the fastest in the industry
- Supports sensor types, such as thermocouple, microvoltage, voltage and current input ranges
- Continuous proportional PID control by 4 to 20 mA current output results in highly stable and accurate control
- Program control function can be specified where set values and PID constants are automatically changed at specific times
- Cascade control function can be performed with channel 1 as the master and channel 2 as the slave

Specifications		Q62HLC	
Input points		2 (2 channels)	
Analog input	thermocouple	°C	-200—+2300 (resolution 0.1 °C)
	microvoltage	mV	-100—+100 (resolution 0.5–10 μV)
	voltage	V	-10—+10 (resolution 0.05–1 mV)
	current	mA	0–20 (resolution 0.8–1 μA)
Digital output		-2000—+23000, -10000—+10000, -10000—+10000, 0–20000	
Supported thermocouples		K, J, T, S, R, N, E, B, PL II, W5re/W26Re	
Conversion speed		25 ms/2 channels	
No. of occupied I/O points		16	
Dimensions (WxHxD)		mm	27.4x98x112
Order information		Art. no.	200693

High-speed counter modules

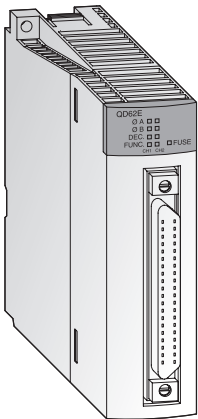

High-speed counter with automatic detection of rotational direction

These counter modules detect high frequency signals which cannot be handled by normal input modules. For example, simple positioning tasks or frequency measurements can be realised.

- Input for incremental shaft encoder with automatic forward and reverse detection
- Preset count via external signals or the PLC program with the aid of the PRESET function
- Ring counter function for counting up to a predefined value with automatic resetting to the starting value
- Functions such as speed measurement, definition of switching points or periodic counting are available
- 40-pin connector interface

Specifications		QD62	QD62E	QD62D	QD60P8-G	QD63P6
Counter inputs		2	2	2	8	6
Signal levels		5/12/24 V DC (2–5 mA)	5/12/24 V DC (2–5 mA)	5/12/24 V DC (2–5 mA) (RS422A)	5/12/24 V DC	5 V DC (6.4–11.5 mA)
Max. counting frequency		kHz	200	200	500 (differential)	30
Max. counting speed	1-phase-input	kHz	200 or 100	200 or 100	500 or 200	30
	2-phase-input	kHz	200 or 100	200 or 100	500 or 200	—
Counting range		32 bits + sign (binary), -2147483648—+2147483647	32 bits + sign (binary), -2147483648—+2147483647	32 bits + sign (binary), -2147483648—+2147483647	16 bits binary: 0–32767, 32 bits binary: -2147483648—+2147483647, 32 bits binary: 0–99999999	32 bits + sign (binary), -2147483648—+2147483647
External digital input points		Preset, function start	Preset, function start	Preset, function start	Preset, function start	Preset, function start
I/O points		16	16	16	32	32
Dimensions (WxHxD)		mm	27.4x98x90	27.4x98x90	27.4x98x90	27.4x98x90
Order information		Art. no.	132579	128949	132580	145038
						213229

MELSEC System Q web server module

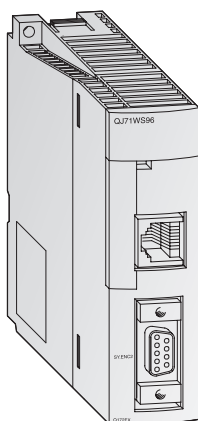

QJ71WS96

The web server module QJ71WS96 enables the remote control monitoring of MELSEC System Q.

- Access to the PLC via the internet
- Very easy setting functions integrated
- User needs only a Web browser for setting and monitoring.
- RS232 interface for modem connection
- Various connections for data exchange are possible: ADSL, modem, LAN, etc.
- Sending and receiving data via mail or FTP
- Integration of a self-designed web site and Java applets is possible
- Standard connection via Ethernet to exchange data between other PLCs or PCs
- Events and CPU data protocol, storage functions

Specifications	QJ71WS96	
Module type	Web server, FTP server/client	
Communications method	Ethernet: CSMA/CD	
Interface	type 10BASE-T/100BASE-TX	
RS232 communications data	interface	RS232, 9-poles D-Sub
	transfer type	Duplex
	synchronisations method	Start/stop synchronisation
	transfer speed	Mbps 9.6/19.2/38.4/57.6/115.2
	transmission distance	m Max. 15
	data format	1 start bit, 8 data bits, 1 stop bit
transfer control	floating control is possible (RS/CS)	
Memory capacity	MB 5 (Standard-ROM); expandable with CompactFlash Card up to 512	
I/O points	32	
Internal power consumption (5 V DC)	mA 500	
Dimensions (WxHxD)	mm 27.5x98x90	
Order information	Art. no. 147115	

MELSEC System Q power measurement module

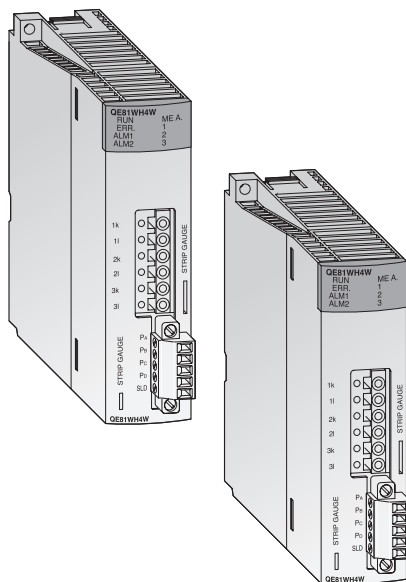

QE81WH4W/QE83WH4W

The power measurement modules QE81WH4W and QE83WH4W detect the voltage and current consumption of loads and calculate the power of the absorbed and emitted energy. This provides not only specific measures to conserve energy, but also optimizes the production processes, the preventive maintenance (e.g. at increased power consumption) and the active state control of loads (e.g. by monitoring the current consumption of heating systems).

- Direct connection of current transducers
- For voltage input the voltage converter QE8WH4VT is required.
- Space-saving installation on the base unit
- Saving of external measuring devices, wiring and communication modules
- Measured values are available directly in the PLC and can be evaluated or e.g. displayed on a GOT.
- Allows for easy power management

Specifications	QE81WH4W	QE83WH4W
Measuring circuit	phase wire system	3-phase (4-wire)
	rated voltage	110 V AC, 480 V AC (When an optional external instrument transformer is used, voltages from 440 V to 6600 V can be measured.)
	rated current	5 A, 50 A, 100 A, 250 A, 400 A, 600 A (Using an optional external current transformer, currents up to 6000 A can be measured.)
	no. of circuits	1 3
Measured items	Current, voltage, frequency, current demand*, active power, active power demand*, power factor, active energy (consumption, regenerative), reactive energy, energy consumption over a specified time period	
	current, voltage, power	±1.0 %
Accuracy	power factor	±3.0 %
	active energy	±2 % (within 5 to 100% of rated range, power factor = 1)
	Buffer memory data update rate	250 ms
Power failure compensation	Settings and measured items are backed up in a non-volatile memory	
I/O points	16	
Dimensions (WxHxD)	mm 27.4x98x90	27.4x98x90
Order information	Art. no. 259456	259457

*"Demand" is the average movement within the specified time period.

MELSEC System Q voltage converter

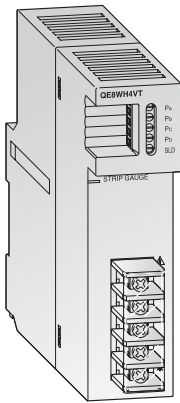

QE8WH4VT

The voltage converter QE8WH4VT is required for voltage input to a power measurement module Q81WH4W or QE83WH4W.

Up to five Power measurement modules can be connected to one QE8WH4VT.

Specifications	QE8WH4VT
Phase wire system	3-phase (4-wire)
Input voltage range	63.5/110 V to 277/480 V AC (cannot operate at less than 55/95 V AC)
Frequency	50/60 Hz
Voltage output permissible tolerance	±1.0 % (relative to rated primary voltage)
No. of connected units max.	5
Consumption current	30 mA
Secondary-side cable length	Max. 5 m
Mounting method	DIN rail mounted, screw mounted
Dimensions (WxHxD)	mm 27.4x98x90
Order information	Art. no. 259458

MELSEC System Q MES interface module

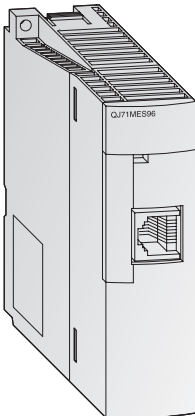

QJ71MES96

The MELSEC System Q MES module allows users to interface their production control systems directly to an MES database.

- It removes the need for an interfacing PC layer – reducing hardware costs and installation time.
- It removes the need for specialist interfacing software run on the PC layer; saving on expensive software and services while reducing installation costs.

- It simplifies the MES architecture reducing the total commissioning time.
- It can improve reliability and accessibility as the module is based on industrial PLC design standards.
- The simplified system provides greater direct data visibility increasing the opportunity to achieve higher productivity.

Specifications	QJ71MES96	
Module type	MES interface module	
Communications method	Ethernet	
Interface	type 10BASE-T/100BASE-TX	
DB interface function	general	Interacts with databases via user-defined jobs
	tag function	Collects device data of the PLCs CPU on the network in units of tags.
	trigger monitor function	Monitors the status of conditions (time, tag values, etc.)
	trigger buffering function	The MES module buffers the data and trigger time to internal memory.
	SQL text transmission	Automatically generates the correct SQL message according to requirements.
	arithmetic processing	Formulas can be applied to data before sending from the MES interface module.
program execution function	Executes programs in the application server computer	
Memory capacity	1 CompactFlash Card can be installed	
I/O points	32	
Internal power consumption (5 V DC)	650 mA	
Dimensions (WxHxD)	mm 27.5x98x90	
Order information	Art. no. 200698	

High speed data logger module

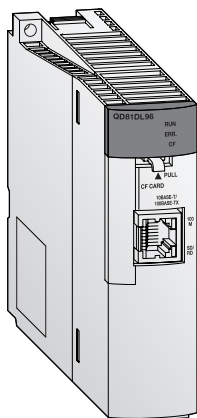

Easy data logging

The high speed data logger module can log programmable controller devices without using a personal computer.

By easily configuring the module, sampled data can be saved in the optimal file format to a CompactFlash card.

- Trigger logging function for accelerated problem analysis
- Data can be saved in list or report format to a CompactFlash Card
- Equipment error detection and failure prediction
- A single QD81DL96 module can access up to a maximum of 64 PLC CPUs

Specifications		QD81DL96
Ethernet	interface ^①	10BASE-T/100BASE-TX
	data transmission rate	10BASE-T: 10 Mbps/100BASE-TX: 100 Mbps
	transmission method	Base band
	no. of cascaded stages	10BASE-T: max. 4/100BASE-TX: max. 2
	max. segment length ^②	m 100
	supported function	Auto-negotiation function supported (automatically distinguishes 10BASE-T/100BASE-TX)
CompactFlash card	supply power voltage	3.3 V \pm 5 %
	supply power capacity	mA Max. 150
	card size	TYPE I card
	no. of installable cards	1
I/O points		32
Clock		Obtained from a programmable controller CPU (in multiple CPU system, CPU No. 1) or SNTP server Time accuracy after obtaining the time is a daily variation of \pm 9.504 seconds ^③
Internal power consumption (5 V DC)	A	0.46
Weight	kg	0.15
Dimensions (WxHxD)	mm	27.4x98x90
Order information		Art. no. 221934

- ① The high speed data logger module distinguishes 10BASE-T from 100BASE-TX according to the external device.
For connection to a hub without an auto-negotiation function, set the hub to half-duplex communications mode.
- ② Distance between a hub and node.
- ③ For programmable controller CPU, everyday (once in 24 hours); for SNTP server, re-obtains the time at the user specified interval.

Multi-function counter/timer module

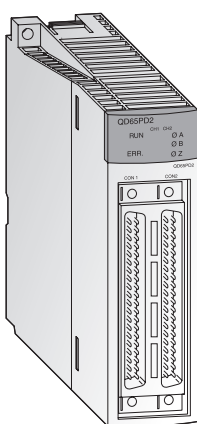

High-speed counter/timer module with cam switch function

Due to its high-speed counter inputs, PWM outputs for control DC drives and the integrated cam switching function, the QD65PD2 is well suited for high precision positioning tasks.

- Max. counting speed up to 8 MHz
- Pulse measurement function with a resolution of 100 ns
- Precisely control PWM output up to 200 kHz
- The integrated cam switch function reduces the programming effort
- Integrated digital I/Os
- Connection via two 40-pin plug-in connectors with screws

Specifications		QD65PD2
Counter inputs		2
Signal levels	DC input	5/12/24 V DC (7–10 mA)
	Differential input	Conforms to RS422A
Max. counting frequency	DC input	kHz 200
	differential input	kHz 8000
Counting range		32 bits + sign (binary), -2147483648—+2147483647
External digital input points		6 phase Z inputs; function start and preset count 6 general purpose inputs
External digital output points		8 coincidence outputs, which are activated by comparison of the count value with the user range 8 general purpose outputs
Cam switch	integrated outputs	8
	program cycle period	1 ms
PWM outputs	output frequency	DC to 200 kHz
	duty ratio	Any ratio can be set (resolution: 0.1 μ s)
Dimensions (WxHxD)	mm	27.4x98x90
Order information		Art. no. 245113

Interrupt module and high-speed inputs

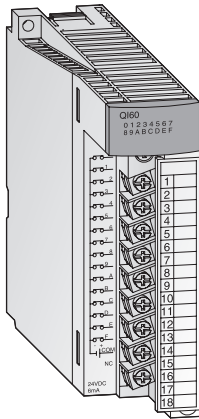

Branching to subroutines

The interrupt module QI60 is suitable for applications demanding quick responses.

- Every input in this module is assigned to a pointer which serves as a breakpoint for a subroutine
- If an interrupt/alarm signal is applied at an input, the PLC program is interrupted after it has worked through the current statement and a subroutine assigned to the input is first processed

- Galvanic isolation between process and controller by means of a photocoupler is a standard feature
- Only one QI60 can be installed per PLC system

High-speed input modules

- Fast response times, 5 μs–1 ms adjustable
- Input voltage 24 V and 5 V
- Can be configured as interrupt or input module

4

Modular PLCs

Specifications	QI60	QX40H	QX70H	QX80H	QX90H	
Input points	16	16	16	16	16	
Rated input voltage	V DC	24 (sink type)	24	5	5	
Operating voltage range	V DC	20.4–28.8	20.4–28.8	4.25–6	4.25–6	
Input	resistance	Ca. 3.9 kΩ	ca. 3.9 kΩ	ca. 470 Ω	ca. 3.9 kΩ	
	current	mA	Ca. DC 4/8	ca. DC 6	ca. DC 6	ca. DC 6
ON	voltage	V	≥DC 19	≥DC 13	≥DC 13	≥DC 3.5
	current	mA	≥DC 4	≥DC 3	≥DC 3	≥DC 3
OFF	voltage	V	≤DC 11	≤DC 8	≤DC 1	≤DC 1
	current	mA	≤DC 1.7	≤DC 1.6	≤DC 1	≤DC 1
No. of occupied I/O points	16	16	16	16	16	
Dimensions (WxHxD)	mm	27.4x98x90	27.4x98x90	27.4x98x90	27.4x98x90	
Order information	Art. no.	136395	221844	221855	221856	221857

Interface module

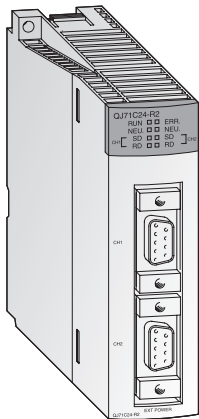

Data exchange with peripheral devices

This module enables communication with peripheral devices via a standard RS232 interface. The peripherals are connected point-to-point on a 1:1 basis.

- The QJ71C24 provides one RS232 and one RS422/485 interface and the QJ71C24-R2 provides two RS232 interfaces
- Enables PCs connected to the system to access the full data set of the MELSEC System Q CPU using graphic process supervision or monitoring software

- Support for plain ASCII data exchange with connected devices such as barcode readers, scales and identification systems
- Options for connection of a printer
- Integrated flash ROM memory for logging quality, productivity or alarm data that can be printed out when required
- Module and communications status shown by LED

Specifications	QJ71C24N	QJ71C24N-R2	QJ71C24N-R4	QJ71MB91	
Interface type	channel 1	RS232 (9-pin Sub-D)	RS232 (9-pin Sub-D)	RS232 (9-pin Sub-D)	
	channel 2	RS422/RS485 (screw terminals)	RS232 (9-pin Sub-D)	RS422/RS485 (screw terminals)	
Communications mode	Full duplex/half duplex	Full duplex/half duplex	Full duplex/half duplex	Full duplex/half duplex	
Synchronisation	Asynchronous communications	Asynchronous communications	Asynchronous communications	Master/Slave	
Data transfer	rate	50–230400 (channel 1 only) 115200 (channel 1+2 simultaneously)	15	300–115200	
	distance	bit/s	15	15	
Network configuration	RS232: 1:1; RS485: 1:1; 1:n; n:1; m:m	1:1	RS232: 1:1; RS485: 1:1; 1:n; n:1; m:m	Master (32 slaves) Slave (242)	
Data format	1 start bit, 7 or 8 data bits, 1 or 0 parity bits, 1 or 2 stop bits	1:1	Parity check, checksum	Modbus	
Error correction	Parity check, checksum	Parity check, checksum	Parity check, checksum	—	
DTR/DSR control	YES/NO selectable	YES/NO selectable	—	—	
X ON/X OFF (DC1/DC3)	YES/NO selectable	YES/NO selectable	YES/NO selectable	—	
I/O points	32	32	32	32	
Dimensions (WxHxD)	mm	27.4x98x90	27.4x98x90	27.4x98x90	
Order information	Art. no.	149500	149501	149502	167757

MELSEC Safety PLC

Even with increasing productivity, the safety of humans operating machinery and manufacturing facilities must still always have top priority. The MELSEC System QS PLC is specially designed for managing safety systems.

It is connected to safety devices like Emergency Stop switches and light curtains and has extensive diagnostics functions that enable it to reliably switch safety-critical outputs at the right time to turn machines off in the event of danger.

The actual machinery (conveyor belts, robots etc.) is still controlled by a conventional PLC.

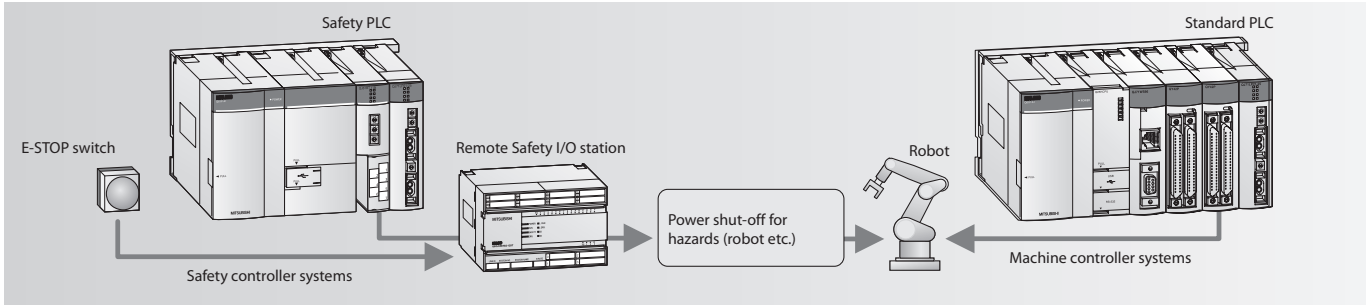

CC-Link Safety

The CC-Link Safety network eliminates the complex wiring needed in conventional safety controller systems. The remote Safety I/O stations are connected to the CC-Link master module in the Safety PLC using standard CC-Link cables. In the event of communications errors powerful and effective error identification routines automatically switch off the outputs of both the Safety PLC and the remote Safety I/O stations. CC-Link Safety is also compatible with CC-Link. This means you can also use standard CC-Link I/O modules in a CC-Link Safety network for those inputs and outputs that are not critical for safety.

- Conforms to the safety requirements of EN 954-1, Category 4 (2010: ISO13849-1 PLc)
- Automatic checking of safety inputs and outputs and external devices (cable breaks, short circuits, fused contactor contacts etc.)
- Program and configure with the familiar GX Developer or GX IEC Developer programming software packages. No new skills or software are required.
- Reduced wiring requirements cuts costs

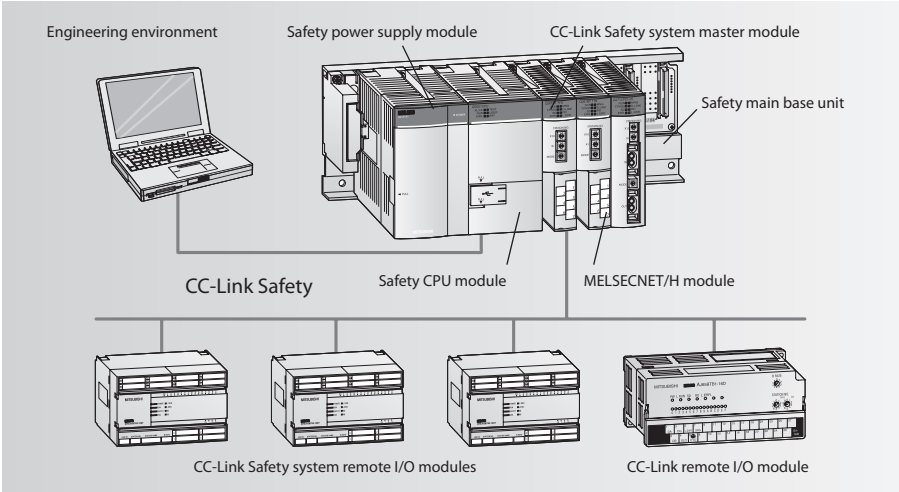

- Comprehensive diagnostics functions
- Versatile: A single Safety CPU can control up to 84 remote safety stations
- The CC-Link standard enables connection of third-party products compatible with the safety concept

Type	Safety Controller Components	Art. no.
QS001CPU	Safety PLC, 14 K steps program capacity	203205
QS034B-E	Safety base unit, accommodates power supply unit, CPU and up to 4 modules	203206
QS061P-A1	Safety power supply unit, 100–120 V AC	203207
QS061P-A2	Safety power supply unit, 200–240 V AC	203208
QS0J61BT12	CC-Link Safety master module	203209
QS0J65BTB2-12DT	Safety remote I/O module, 8 dual safety inputs + 4 dual safety outputs	203210
QS0J65BTS2-8D	CC-Link Safety remote I/O module, 8 dual safety inputs	217625
QS0J65BTS2-4T	CC-Link Safety remote I/O module, 4 dual safety outputs	217626
QS0J71GF11-T2	CC-Link Safety master module (local module)	245177

Safety relays

Safety relay modules are the ideal solution for applications where you don't need a separate Safety PLC. These modules are installed together with the standard MELSEC System Q components on the same base unit, or in a CC-Link network. This enables a normal PLC used as a controller to also perform safety functions, without the added cost of a separate safety controller and without additional programming and configuration.

- The safety modules conform to the safety requirements of EN 954-1, Category 4 (2010: ISO 13849-1 PLe)
- Simple configuration without programming
- Easy retrofitting on existing systems
- The PLC monitors your safety functions, enabling fast diagnostics
- Extension modules allow easy modification

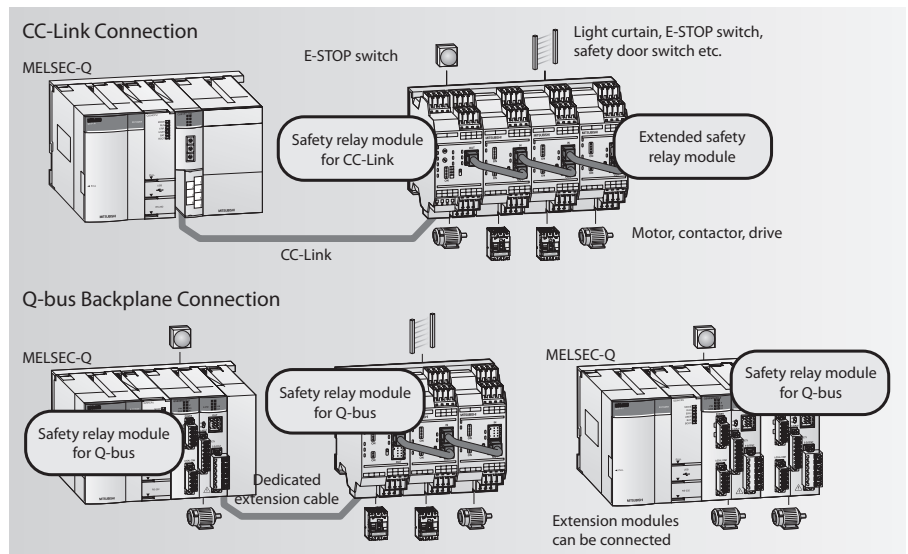

Specifications	Module	Type	Art. no.	
Safety relay modules	For installation in a CC-Link station	QS90SR2SP-CC	P-Type, 1 safety input, 1 safety output	215801
		QS90SR2SN-CC	N-Type, 1 safety input, 1 safety output	215803
	For installation on a MELSEC System Q base unit	QS90SR2SP-Q	P-Type, 1 safety input, 1 safety output	215799
		QS90SR2SN-Q	N-Type, 1 safety input, 1 safety output	215800
Extension modules	Can be connected to safety relay modules	QS90SR2SP-EX	P-Type, 1 safety input, 1 safety output	215804
		QS90SR2SN-EX	N-Type, 1 safety input, 1 safety output	215805

MELSEC WS Safety Controller

The MELSEC WS Safety Controller provides a cost effective way to add a safety controller capability to individual machines, or smaller scale systems. Mitsubishi Electric is proud to announce that the WS is a joint development with SICK AG of Germany, an acknowledged leader in the global machine safety industry. Its compact size insures easy placement in most control cabinets, without adding extra cost. Configuration saves engineering time by using a graphical icon based method, and program development and certification is simplified by the use of safety function blocks. For more complex needs, the WS is also scalable by simply adding additional I/O modules. Finally, integration with conventional control systems is easily achieved with the CC-Link open network connection or Ethernet.

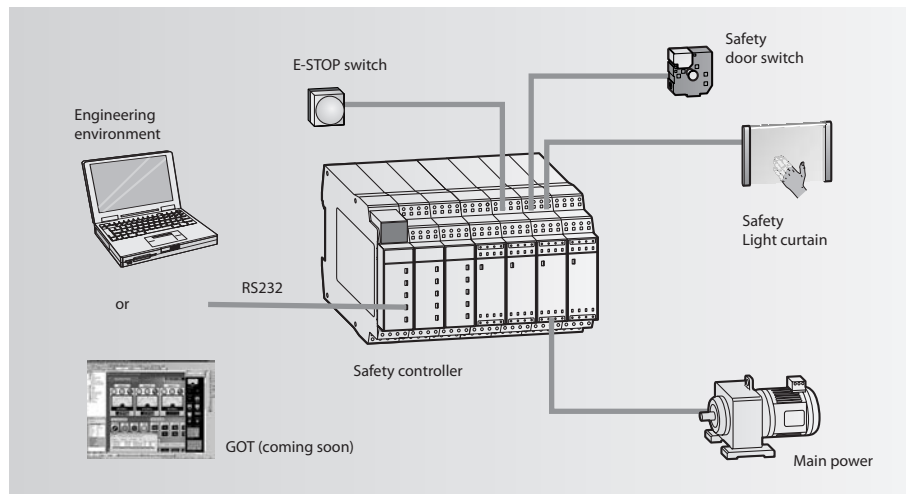

Function	Module	Description	Art. no.
CPU	WS0-CPU000200	Program memory: 255 function blocks	230057
	WS0-CPU130202	Program memory: 255 function blocks; EFI (direct communication with SICK safety devices)	230058
Input module	WS0-XTDI80202	8 safety inputs	230059
Input/output modul	WS0-XTIO84202	8 safety inputs; 4 safety outputs	230060
Output module	WS0-4RO4002	4 safety relay outputs	230064
Communication module	WS0-GETH00200	Module for Ethernet communication	230063
	WS0-GCC100202	Module for CC-Link communication	235441
Memory	WS0-MPL000201	Memory plug	230061
Programming cable	WS0-C20R2	Serial programming cable	230062

Accessories

Connection cables

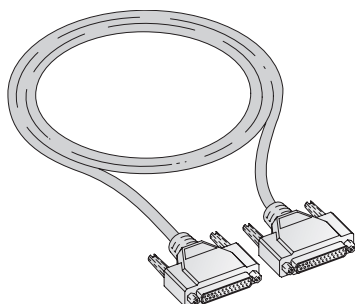

Connection cable for extension units

These connection cables are used for connecting base units to the extension units.

When multiple extension cables are used, the overall distance of the cables should be within 13.2 m.

Specifications	QC06B	QC12B	QC30B	QC50B	QC100B
For extension base units	Q63B, Q65B, Q68B, Q612B	Q63B, Q65B, Q68B, Q612B	Q63B, Q65B, Q68B, Q612B	Q63B, Q65B, Q68B, Q612B	Q63B, Q65B, Q68B, Q612B
Length	m	0.6	1.2	3.0	5.0
Order information	Art. no.	129591	129642	129643	129644

Programming cable

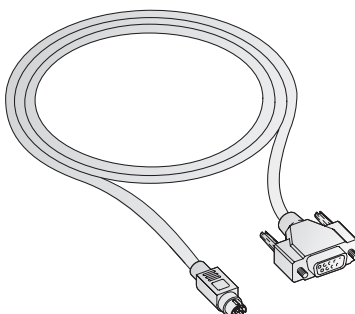

Programming cable for RS232 interface

The QC30R2 and QC30-USB cables are used for programming a MELSEC System Q CPU via the RS232 and standard USB ports.

The programming cable provides a 9-pin D-Sub connector for the PC side and a 6-pin Mini-DIN connector for the PLC interface.

Specifications	QC30R2	QC30-USB	USB-CAB-5M
Connection cable for	Connection between a PCs and a MELSEC System Q PLC via RS232 interface	Connection of a PC to a MELSEC System Q CPU via a standard USB port	Connection of a PC to an iQ CPU in the MELSEC System Q via a mini-USB port
Length	m	3.0	5.0
Order information	Art. no.	128424	136577
Accessories	Connector disconnection prevention holder Q6HLD-R2	—	—

Tracking cable

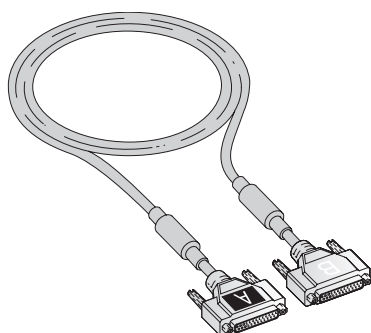

Connection cable for redundant PLCs

The tracking cable is used for connecting the two PLCs of a redundant system. For connection in a redundant system only the cables QC10TR and QC30TR can be used.

The connectors of the tracking cable are marked with "A" and "B" for "System A" and "System B". When both systems are started at the same time System A becomes the control system and System B the standby system.

Specifications	QC10TR	QC30TR
Connection cable for	Connection between the two PLCs of a redundant system	
Length	m	1.0 m
Order information	Art. no.	157068

Battery Q6BAT

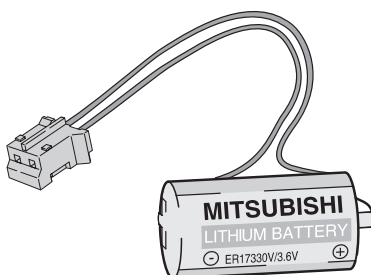

Backup battery

The lithium battery Q6BAT is the replacement for the battery integrated for data backup in any MELSEC System Q CPU.

Specifications	Q6BAT
Voltage	V DC
Capacity	mAh
Dimensions (ØxH)	mm
Order information	Art. no.

ERNT – Conversion adapters

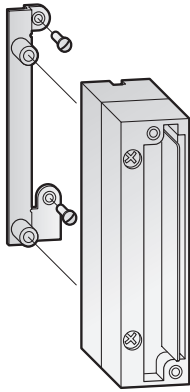

AnS series adapters -> MELSEC System Q

These adapters enable a PLC of the MELSEC AnS or A series to be easily replaced by a MELSEC System Q PLC.

The terminal block adapters enable existing wiring for modules of the MELSEC AnS/A series to be connected to MELSEC System Q modules. The mounting adapters enable a MELSEC System Q base unit to be fitted using the existing fixing holes of the MELSEC AnS series.

4

Modular PLCs

Item	Application	Art. no.
ERNT-ASQTX10	Terminal block A1SX10/A1SY10 to QX10/QY10	249093
ERNT-ASQTX40	Terminal block A1SX40(-S1/S2) to QX40(-S1)	249094
ERNT-ASQTX80	Terminal block A1SX80(-S1/S2) to QX80	249135
ERNT-ASQTY22	Terminal block A1SY22 to QY22	249136
ERNT-ASQTY40	Terminal block A1SY40(P) to QY40P	249137
ERNT-ASQTY50	Terminal block A1SY50 to QY50	249138
ERNT-ASQTY80	Terminal block A1SY80 to QY80	249139
ERNT-ASQT64AD	Terminal block A1S64AD to Q64AD	249140
ERNT-ASQT68AD	Terminal block A1S68AD to Q68AD(V/I)	249141
ERNT-ASQT62DA	Terminal block A1S62DA to Q62DAN	249142
ERNT-ASQT68DA	Terminal block A1S68DA(V/I) to Q68DA(V/I)N	249143
ERNT-ASQB38	Base unit A1S38(H)B to Q38B	249144
ERNT-ASQB35	Base unit A1S35B to Q35B	249145
ERNT-ASQB33	Base unit A1S33B to Q33B	249146
ERNT-ASQB00J	Base unit A1SJ(H)CPU(-S3) to Q00(U)JCPU	249147
ERNT-ASQB68	Base unit A1S68B to Q68B	249148
ERNT-ASQB65	Base unit A1S65B to Q65B	249149
ERNT-ASQB55	Base unit A1S55B to Q55B	249150

Item	Application	Art. no.
ERNT-AQTY10A	Terminal block AY10A/AY11A/AY11AEU to QY18A (2 modules required)	231670
ERNT-AQTY13	Terminal block AY13/AY13E/AY13EU to QY10 (2 modules required)	231671
ERNT-AQTY23	Terminal block AY23 to QY22 (2 modules required)	231672
ERNT-AQTX11	Terminal block AX11/AX11EU to QX10 (2 modules required)	231673
ERNT-AQTY51	Terminal block AY51/AY51-S1 to QY50 (2 modules required)	231674
ERNT-AQT68AD	Terminal block A68AD/A68AD-S2 to Q68ADV/Q68ADI	231705
ERNT-AQT68ADN	Terminal block A68ADN to Q68ADV/Q68ADI	231706
ERNT-AQT62DA	Terminal block A62DA/A62DA-S1 to Q62DAN	231707
ERNT-AQT68DA	Terminal block A68DAV/A68DAI/A68DAI-S1 to Q68DAVN/Q68DAIN	231708
ERNT-AQTD61	Terminal block AD61 to QD62	231709
ERNT-AQT68AD-GH	Terminal block A68AD/A68AD-S2/A68ADN to Q64AD-GH (2 modules required)	231710
ERNT-AQT616AD	Terminal block A616AD to Q68ADV/Q68ADI (2 modules required)	231711
ERNT-AQT616DA	Terminal block A616ADV/A616ADI to Q68ADV/Q68ADI (2 modules required)	231712

Wireless LAN Adapter

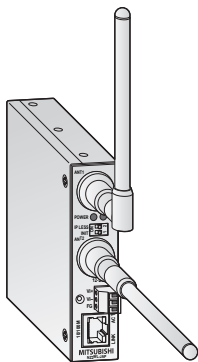

Wireless connection to networks

With the wireless LAN adapter NZ2WL-EU, a PLC system can be wirelessly connected to a network (LAN). This shortens the configuration and connection process at end-user facilities. The adapter

complies to directives IEEE 802.11 a/b/g and can be configured as an access point or station.

Specifications		NZ2WL-EU
Wired LAN	Communications speed	10/100 Mbit/s
	Communications mode	Half duplex/full duplex
	Number of interfaces	1 (10BASE-T/100BASE-TX)
1 (10BASE-T/100BASE-TX)	Transmission method	Conforms to IEEE802.11 a/b/c
	Communications speed	1–54 Mbit/s
External power consumption	Voltage	12–24 V DC
	Current	Max. 0.4 A at 12 V DC, max. 0.2 A at 24 V DC
Dimensions (without aerial) (WxHxD)	mm	25x97x68
Weight	kg	0.25
Order information		Art. no. 249090

Modular PLCs MELSEC L series

The MELSEC L series is a powerful but compact modular controller with many features built-in to the CPU itself. The rack-free design promotes high system flexibility with minimum form factor. Built-in Mini-B USB and Ethernet allow for easy communication, along with a built-in SD/SDHC memory slot for data logging and memory storage, and built-in digital I/O for simple high-speed counting and positioning functions.

The high-performance version CPU also includes a built-in CC-Link interface for Master/Local Station networking. This highly flexible architecture makes the MELSEC L series ideal for both stand-alone and networked machines.

- Rack-free design
- CPUs packed with comprehensive built-in features/functions
- Integrated data logging

- Built-in I/O features
- Communication and networking capabilities
- High-end 4/16-axis motion expansion possible using SSCNETIII

Equipment features

The modular design of MELSEC L series allows flexible usage in a broad range of applications. The following modules are available for assembling and expanding the system:

Use of digital and special function modules

The use of digital and analog modules and most special function modules is dependent only on the maximum available number of addresses and thus on the CPU used in each case.

The built-in data logging function provides an easy way to collect information for troubleshooting, performance evaluation, and other uses. The included configuration tool makes setting up the data logging function a breeze with a step-by-step wizard like interface.

Using GX LogViewer, the captured data is easy to interpret and understand.

Communications modules

Modules with RS232/RS422/RS485 interface to connect devices for PLC-to-PLC communication. IO-Link module for the connection of intelligent sensors.

Network modules

For interfacing with CC-Link or CC-Link IE networks.

Positioning modules

High-speed counter modules with possibility for connection of incremental shaft encoder or multi-axial positioning modules for servo and step drives with up to 4 axes per module.

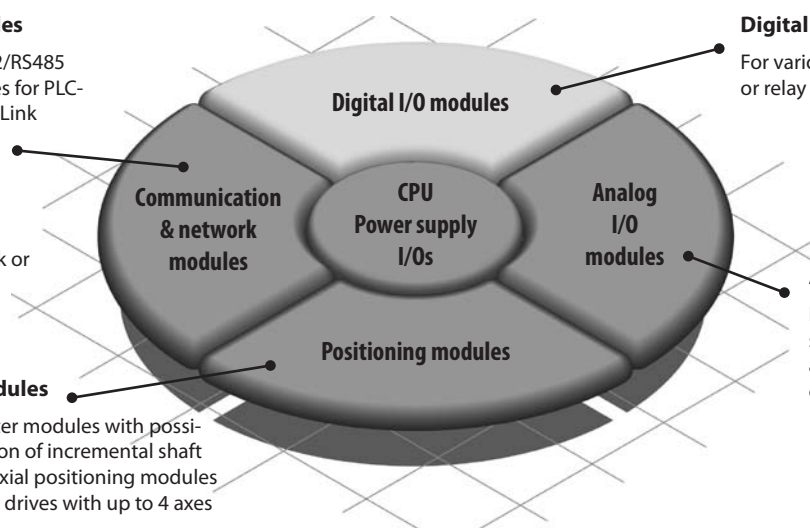

Digital input/output modules

For various signal levels with transistor, or relay switches.

Analog input/output modules

For processing current/voltage signals and for temperature value acquisition as well as temperature control.

Built-in I/O features

Every MELSEC L series CPU comes with 24 points of built-in I/Os as standard. These I/O points are capable of many functions usually reserved for separate modules. System costs can be saved by using the built-in functions rather than relying exclusively on additional modules.

Function		Features
Positioning*	Control of maximum two axes	Maximum speed: 200 kpulse/s High-speed activation: 30 μ s (shortest activation time) S-curve acceleration and deceleration are supported
High-speed counter*	Two built-in channels	Maximum counting speed: 200 kpulse/s Open collector, differential line driver input High accuracy ON/OFF measurements with a resolution of 5 μ s High precision PWM control up to 200 kHz (High speed pulse output)
Pulse catch	16 input points	Minimum input response time: 10 μ s Pulse signals whose ON time is shorter than the scan time can be detected.
Interrupt input	16 interrupt input points	Built-in CPU provides high-speed processing. All input points support interrupt inputs.
General input	6 high-speed input points, 10 standard input points	Minimum input response time of high-speed input: 10 μ s Minimum input response time of standard input: 100 μ s
General output	8 output points	Output response time: 1 μ s or less

* Points used by the positioning and high speed counting functions are fixed (as in A phase, B phase, near-point dog). Custom points for these functions may not be assigned.

What a system looks like

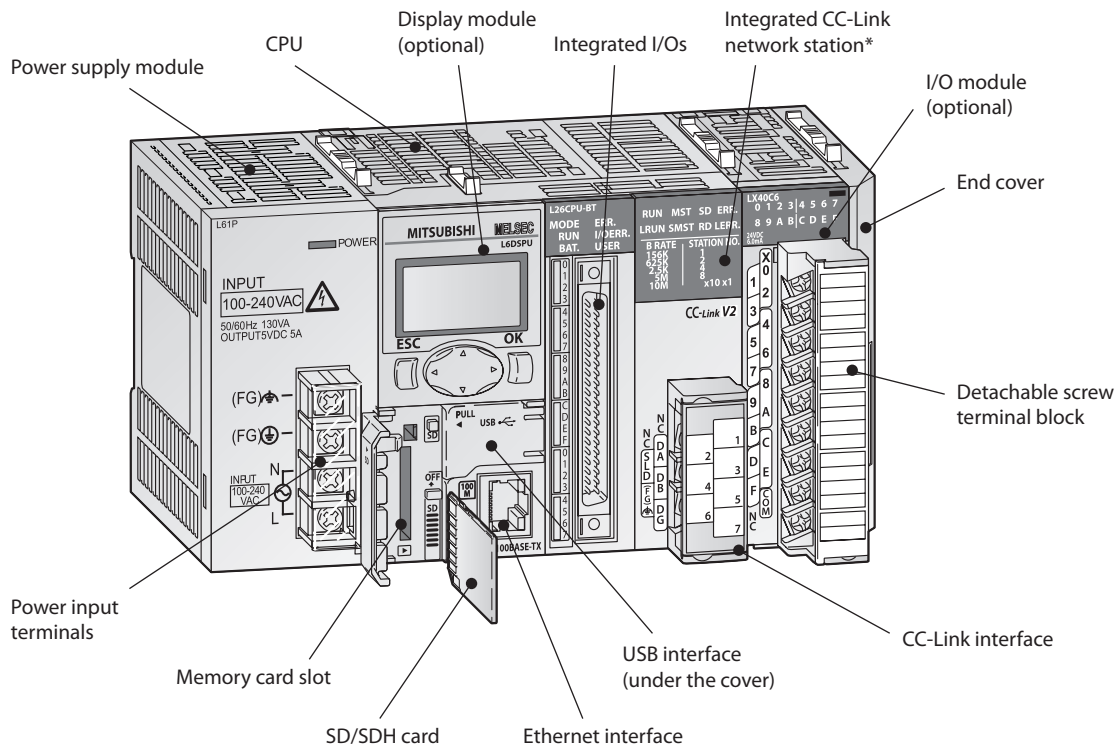

* High-performance CPU only

System structure

The MELSEC L series is a powerful but compact modular controller with many features built-in to the CPU itself. The rack-free design promotes high system flexibility with minimum form factor. By connecting various types of modules, the system can be enhanced according to the application. Up to 10 expansion modules can be added per system configuration. As a baseless structure is employed, the space of the control panel can be used effectively without being limited by the size of the base.

MELSEC L series controllers are all-in-one programmable controllers that have the following functions built into the CPU module:

- 2 channels of high-speed counters up to 200 kHz
- Positioning possibilities for two axes, also up to 200 k pulses per second
- Built-in Ethernet communication

- Built-in I/Os which are available via a 40-pin high density connector supporting several I/O options
- High-speed data logging to the SD memory card
- CC-Link Ver. 2 Master/Slave interface (in the high-performance CPU)
- Full support in iQ Works and GX Works2

What you need

Power supply

This provides 5 V DC power for all modules on the back plane. There are two types of power supplies available, the selection is dependent on the available supply voltage.

CPU

There are several CPU types for different applications available in a range of standard, middle and high performance. All CPUs come with built-in Mini-B USB and digital I/Os for simple high-speed counting and positioning functions. Most of the CPUs have also built-in Ethernet for easy communication, along with a built-in SD/SDHC memory slot for data logging and memory storage.

The high-performance version CPU also includes a CC-Link interface for Master/Local station networking.

I/Os

There is a wide selection of digital input and output modules depending on the signal level, sink or source designation and density of points required. Modules are available in 16 point input or output with screw terminals mounted on the module, higher densities of 32 and 64 point require a connector, cable and terminal block.

Special function modules

For special applications analog I/O and intelligent modules for motion, positioning, high-speed counting, communication, and networking are available.

Power supply modules

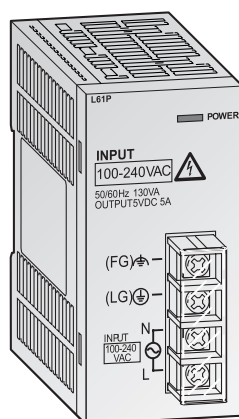

These units power the CPU and all connected modules. The choice is dependent on the input power that is available.

- The power module L61P can be used worldwide with its wide input range from 100 to 240 V AC at 50/60 Hz.

- For applications powered by 24 V DC the L63P is used.
- LED indicator for operating status
- Screw terminals for power input on the front side

Specifications	L61P	L63P
Input voltage	(+10 %, -15 %) V AC (+30 %, -35 %) V DC	100–240 —
Input frequency	Hz	50/60 (±5 %) —
Inrush current	20 A within 8 ms	100 A within 1 ms (24 V DC input)
Max. input apparent power	130 VA	—
Max. input power	—	45 W
Rated output current (5 V DC)	A	5 5
Overcurrent protection (5 V DC)	A	≥5.5 ≥5.5
Overvoltage protection	V	5.5–6.5 V 5.5–6.5 V
Efficiency	≥70 %	≥70 %
Max. compensation time at power failure	ms	Within 10 ms Within 10 ms (24 V DC input)
Dimensions (WxHxD)	mm	45x90x109 45x90x109
Order information	Art. no.	238063 238064

CPU modules

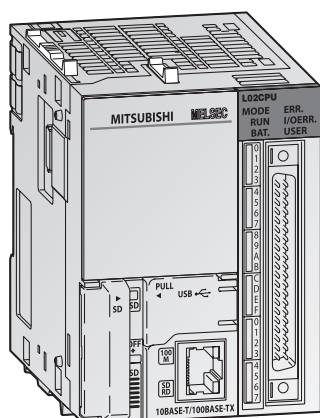

The CPU modules are the heart of a MELSEC L series system and contain a diverse range of control functions. Every CPU comes with 24 points of built-in I/Os.

For many standard applications the L02SCPU(-P) or L02SCPU(-P) is appropriate. When higher operation processing speed is needed the L06CPU(-P) or L26CPU(-P)(BT) is the right choice. The L26CPU(-P)(BT) provides the highest program capacity. This CPU provides furthermore a built-in CC-Link connectivity.

- High-speed processing
- Large memory capacity
- Integrated Data logging
- Integrated USB port for programming
- Integrated Ethernet interface for efficient network or PC communication
- SD card memory slot for quick and easy backup of programs and parameters

Specifications	L02SCPU/ L02SCPU-P	L02CPU/ L02CPU-P	L06CPU/ L06CPU-P	L26CPU/ L26CPU-P	L26CPU-BT/ L26CPU-PBT	
Control method	Stored program repeat operation					
Number of I/O points	1024/8192*	1024/8192*	4096/8192*	4096/8192*	4096/8192*	
Programming language	Function block, relay symbol language, MELSP3 (SFC), MELSP-L, structured text (ST), logic symbolic language					
Basic operation processing speed	60 ns	40 ns	9.5 ns	9.5 ns	9.5 ns	
Program size (no. of steps)	20 k	20 k	60 k	260 k	260 k	
Memory capacity	program memory	byte	80 k	80 k	240 k	1040 k
	memory card	—	Depends on the SD/SDHC memory card used			
	standard RAM	byte	128 k	128 k	768 k	768 k
	standard ROM	byte	512 k	512 k	1024 k	2048 k
Built-in functions	integrated I/Os	16 inputs (24 V DC)/8 outputs (5–24 V DC, 0.1 A per channel) ①				
	data logging	10 data logging settings (for each any of 32–4832 kB can be specified)				
	communication	RS232	10 BASE-T/100 BASE-TX (10/100 Mbps)	USB	USB	USB
CC-Link connectivity	—	—	—	—	CC-Link Master/ Local station (up to 10 Mbps)	
Dimensions (WxHxD)	mm	70x90x95	70x90x95	70x90x95	98.5x90x118	
Order information	Art. no.	263070/269668	238057/244976	263068/**	263069/**	238056/244977

* number of points available on a program ** on request

① Model name with "P": source type digital output, model name without "P": sink type digital output.

Digital input modules

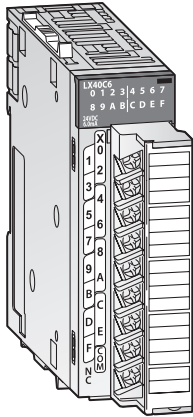

Detection of digital input signals

Various input modules are available for converting digital process signals with different voltage levels into the levels required by the PLC.

All models are capable of using both positive or negative common connections, so that separate modules are not necessary.

- Indication of input status via LED
- Positive/negative common
- Response time 1 to 70 ms
- Modules with 16, 32 or 64 input points available

Specifications		LX40C6	LX10	LX41C4	LX28	LX42C4
Number of input points		16	16	32	8	64
Rated input voltage	V DC	20.4–28.8	100–120 V AC, 50/60 Hz	20.4–28.8	100–240 V AC, 50/60 Hz	20.4–28.8
Rated input current	mA	6.0	8.2 (100 V AC, 60 Hz) 6.8 (100 V AC, 50 Hz)	4.0	16.4 (200 V AC, 60 Hz) 13.7 (200 V AC, 50 Hz) 8.2 (100 V AC, 60 Hz) 6.8 (100 V AV, 50 Hz)	4.0
Input derating (for rated voltage)		100 %	100 % (at 50 °C)	100 %	100 % (at 50 °C)	100 % (at 35 °C)
ON	voltage	V ≥15	≥80	≥19	≥80	≥19
	current	mA ≥4	≥5	≥3	≥5	≥3
OFF	voltage	V ≤8	≤30	≤9	≤30	≤9
	current	mA ≤2	≤1.7	≤1.7	≤1.7	≤1.7
Response time	ms	≤1–70 ①	OFF → ON: ≤15 ON → OFF: ≤20	≤1–70 ①	OFF → ON: ≤10 ON → OFF: ≤20	≤1–70 ①
Inputs per group:		16	16	32	16	32
I/O points		16	16	32	16	64
Status display for the inputs		As operation indicator, all modules are equipped with a LED for each input.				
Connection terminal		18-point removable terminal block with screws	18-point removable terminal block with screws	40-pin connector	18-point removable terminal block with screws	40-pin connector x 2
Internal power consumption (5 V DC)	mA	90	90	100	80	120
Weight	kg	0.15	0.17	0.11	0.15	0.12
Dimensions (WxHxD)	mm	28.5x90x117	28.5x90x117	28.5x90x95	28.5x90x117	28.5x90x95
Order information	Art. no.	238085	255566	238086	255567	238087

① Can be changed in the PLC parameters (Default: 10 ms)

Digital output modules

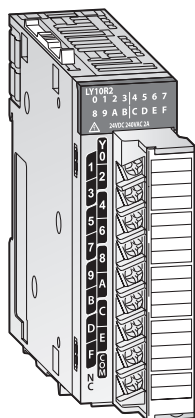

Switching of external processes and devices

The MELSEC L series output modules have different number of outputs and different switching elements for adaptation to many control tasks.

Modules are built with countermeasures in case of external load short-circuits to protect against over-current and overheating.

- Indication of output status via LED
- Sink and source type modules available
- Response time less than 0.5 ms for transistor output modules
- Modules with 16, 32 or 64 output points available

Specifications	LY10R2	LY20S6	LY40NT5P	LY41NT1P	LY42NT1P	LY40PT5P	LY41PT1P	LY42PT1P
Number of output points	16	16	16	32	64	16	32	64
Output type	Relay	Triac	Transistor (sink type)	Transistor (sink type)	Transistor (sink type)	Transistor (source type)	Transistor (source type)	Transistor (source type)
Outputs in groups of	16	16	16	32	32	16	32	32
Rated load voltage	24 V DC/240 V AC	100–240 V AC, 50/60 Hz	24 V DC	24 V DC	24 V DC	24 V DC	24 V DC	24 V DC
Max. switching load	A 2 (8 common)	0.6 (4.8 common)	0.5 (5 common)	0.1 (2 common)	0.1 (2 common)	0.5 (5 common)	0.1 (2 common)	0.1 (2 common)
Response time	OFF → ON	≤10	Total of 1 ms and 0.5 cycles or less	≤0.5	≤0.5	≤0.5	≤0.5	≤0.5
	ON → OFF	≤12	Total of 1 ms and 0.5 cycles or less (resistive load)	≤1	≤1	≤1	≤1	≤1
Load voltage range	<125 V DC/ <264 V AC	85–264 V AC	10.2–28.8 V DC	10.2–28.8 V DC	10.2–28.8 V DC	10.2–28.8 V DC	10.2–28.8 V DC	10.2–28.8 V DC
Protective functions	—	—	Overload protection function, overheat protection function					
I/O points	16	16	16	32	64	16	32	64
Status display for the outputs	As operation indicator, modules with 16 or 32 outputs are equipped with a LED for each output. Modules with 64 outputs have a switchable display with 32 LEDs.							
Connection terminal	18-point removable terminal block with screws	18-point removable terminal block with screws	18-point removable terminal block with screws	40-pin connector	40-pin connector x 2	40-pin connector	40-pin connector	40-pin connector x 2
External power supply of the module	—	—	10.2–28.8 V DC, 9 mA	10.2–28.8 V DC, 13 mA	10.2–28.8 V DC, 9 mA	10.2–28.8 V DC, 17 mA	10.2–28.8 V DC, 20 mA	10.2–28.8 V DC, 20 mA
Internal power consumption 5 V DC	mA 460	300	100	140	190	100	140	190
Weight	kg 0.21	0.22	0.15	0.11	0.12	0.15	0.11	0.12
Dimensions (WxHxD)	mm 28.5x90x117	28.5x90x117	28.5x90x95	28.5x90x95	28.5x90x95	28.5x90x95	28.5x90x95	28.5x90x95
Order information	Art. no. 238088	255568	242167	238089	238090	242168	242169	242170

IO-Link Module

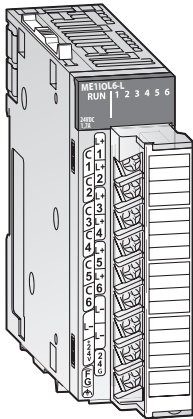

Master module for I/O Link

IO-Link is an extension of conventional digital inputs and outputs and allows the connection of intelligent sensors and actuators to a PLC. The 32-byte input and output data for each device are transmitted over standard cables, special bus cables or communication settings are not necessary.

- Master module for up to six IO-Link devices
- Each channel of the ME110L6-L can also be configured as a normal digital input or output.
- Masking of input data simplifies the data processing by the PLC CPU

- At a stop of the PLC CPU, the output states can either be deleted or retained.
- The parameterized device configuration is checked at the beginning of the IO-Link communication and deviations are detected.
- Storage of the parameters of the IO-Link devices allows the rapid exchange of the device

Specifications		ME110L6-L
No. of channels		6
Channel configuration		IO-Link, digital output, digital input, disabled
IO-Link	rated load voltage	24 V DC
	rated output current	15 mA
	sensor/actuator power supply	200 mA
Digital input	common point	Positive
	rated load voltage	24 V DC
	rated input current	5 mA
	input filter	200 μs
Digital output	rated load voltage	24 V DC
	output type	Source
Rated output current		In total max. 215 mA
Actuator supply		In total max. 215 mA
Protective functions		Overcurrent, overload, short circuit
I/O points		32
Connection terminal		18-point removable terminal block with screws
Applicable cables	cable type	Unshielded cable
	max. length	20 m
	cross-section	0.3–0.75 mm ²
External power consumption	voltage	24 V DC (+20 %, -15 %)
	current	Max. 1.7 A
Weight	kg	0.18
Dimensions (WxHxD)	mm	28.5x90x117
Order information	Art. no.	245825

Analog input modules

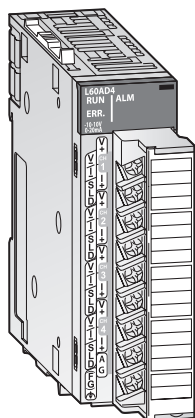

Analog to digital conversion

The analog input module converts analog process signals, for example pressure, flow or fill level, linearly into digital values, which are further processed by the MELSEC L series CPU.

- High-speed conversion of 20 μ s/channel
- High conversion accuracy of $\pm 0.1\%$
- High resolution of 1/20000
- Ensured stability with variable conversion speed
- Easy parameter setting

Specifications			L60AD4	L60AD4-2GH	
Input points			4	4	
Analog input	voltage	V DC	-10–10	-10–10	
	current	mA DC	0–20	0–20	
Digital output			-20480–20479 (-32768–32767)*	-32000–32000 (-32768–32767)*	
Load resistance	voltage	M Ω	1	1	
	current	Ω	250	250	
Max. input	voltage	V	± 15	± 15	
	current	mA	30	30	
I/O characteristics (digital value)	voltage		-20000–20000	-32000–32000	
	current		0–20000	0–32000	
Max. resolution	voltage input	μ V	200	125	
	current input	nA	800	500	
Overall accuracy			$\pm 0.1\%$	$\pm 0.05\%$	
Conversion speed			20 μ s/channel	40 μ s/2 channels	
Number of occupied I/O points			16	16	
Connection terminal			18-point removable terminal block	18-point removable terminal block	
Internal current consumption			mA	520	760
Dimensions (WxHxD)			mm	28.5x90x117	28.5x90x117
Order information			Art. no.	238091	263071

* Value in brackets when using the scaling function

Analog output modules

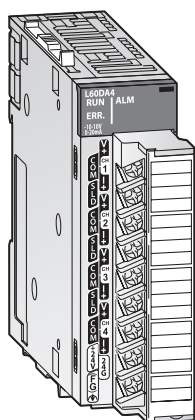

Digital to analog conversion

The analog output module converts digital values predetermined by the CPU into analog current or voltage signal.

- High-speed conversion of 20 μ s/channel
- High conversion accuracy of $\pm 0.1\%$
- High resolution of 1/20000

- Easy parameter setting
- Integrated scaling function

Specifications			L60DA4	
Output points			4	
Digital input			-20480–20479 (-32768–32767)*	
Analog output	voltage	V DC	-10–10	
	current	mA DC	0–20	
Load resistance	voltage	M Ω	0.001–1	
	current	Ω	0–600	
I/O characteristics			digital value	-20000–20000
Max. resolution	voltage input	μ V	200	
	current input	nA	700	
Overall accuracy			$\pm 0.1\%$	
Conversion speed			20 μ s/channel	
Number of occupied I/O points			16	
Connection terminal			18-point removable terminal block	
Internal current consumption			mA	160
Dimensions (WxHxD)			mm	28.5x90x117
Order information			Art. no.	238092

* Value in brackets when using the scaling function

Temperature control modules

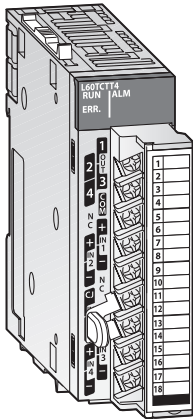

Temperature control modules with PID algorithm

These modules apply the independent control of temperatures. This relieves the CPU of the PLC.

- 4 channels for temperature detection and 4 separate loops of temperature adjustment per module
- Modules for thermocouples and for Pt100 resistance thermometers are available
- Auto tuning function for optimum temperature adjustment control (PID control)

- The modules or single channels of a module can also be used for temperature detection.
- Temperature control can continue even when the PLC program is stopped
- Heating current monitoring at modules L60TCT4BW and L60TCRT4BW to detect a defective or disconnected heater.
- The modules can be used for heating and cooling applications.

4

Modular PLCs

Specifications		L60TCT4	L60TCRT4	L60TCT4BW	L60TCRT4BW
Control output	type	Transistor	Transistor	Transistor	Transistor
Inputs		4 channels per module	4 channels per module	4 channels per module	4 channels per module
Supported temperature sensors		Thermocouple	Pt100 resistance thermometer	Thermocouple	Pt100 resistance thermometer
Sampling cycle		250 ms/4 channels	250 ms/4 channels	250 ms/4 channels	250 ms/4 channels
Control output cycle	s	0.5–100	0.5–100	0.5–100	0.5–100
Input filter		1–100 s (0 s: input filter OFF)			
Temperature control method		PID ON/OFF impulse or 2-position control			
PID constant range	PID constant setting	Setting with automatic tuning possible			
	proportional band P	0.0–1000 % (0 %: 2-position control)			
	integral time I	1–3600 s (set 0 for P control and PD control)			
	differential time D	1–3600 s (set 0 for P control and PI control)			
Target value setting range		Within the temperature range set in the thermocouples/resistance thermometers used			
Dead band setting range		0.1–10.0 %	0.1–10.0 %	0.1–10.0 %	0.1–10.0 %
Transistor output	output signal (sink)	ON/OFF pulse	ON/OFF pulse	ON/OFF pulse	ON/OFF pulse
	rated load voltage	10–30 V DC	10–30 V DC	10–30 V DC	10–30 V DC
	max. load current	0.1 A/1 point, 0.4 A/common	0.1 A/1 point, 0.4 A/common	0.1 A/1 point, 0.4 A/common	0.1 A/1 point, 0.4 A/common
	max. rush current	400 mA for 10 ms	400 mA for 10 ms	400 mA for 10 ms	400 mA for 10 ms
	max. voltage drop when ON	0.1 V DC (TYP) 0.1 A 2.5 V DC (MAX) 0.1 A	0.1 V DC (TYP) 0.1 A 2.5 V DC (MAX) 0.1 A	0.1 V DC (TYP) 0.1 A 2.5 V DC (MAX) 0.1 A	0.1 V DC (TYP) 0.1 A 2.5 V DC (MAX) 0.1 A
	response time	OFF R ON: <2 ms ON R OFF: <2 ms	OFF R ON: <2 ms ON R OFF: <2 ms	OFF R ON: <2 ms ON R OFF: <2 ms	OFF R ON: <2 ms ON R OFF: <2 ms
Insulation method		Transformer between input channels and the power supply and between the inputs			
I/O points		16	16	16	16
Connection terminals		All modules are fitted with a terminal block with 18 screw terminals.			
Applicable wire size	mm ²	0.3–0.75	0.3–0.75	0.3–0.75	0.3–0.75
Internal power consumption (5 V DC)	mA	300	310	330	350
Weight	kg	0.18	0.18	0.33	0.33
Dimensions (WxHxD)	mm	28.5x90x117	28.5x90x117	57x90x117	57x90x117
Order information	Art. no.	246347	246348	246349	246350

High-speed counter modules

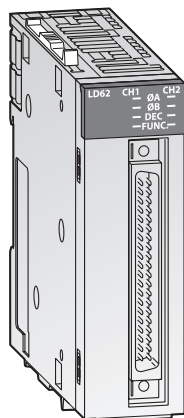

Fast signal counting

The counter modules detect high-frequency signals, which cannot be handled by normal input modules.

- Periodic pulse counter function
- High-speed pulse measurement of up to 500 k pulses/s (LD62D)
- Linear and latch counter

- Ring counter function for counting up to a predefined value with automatic resetting to the start value
- Coincidence output function
- Easy configuration of the modules with GX Works2

Specifications	LD62	LD62D
Counter inputs (channels)	2	2
Count input signal	1-phase input (multiple of 1/2), CW/CCW, 2-phase input (multiple of 1/2/4)	EIA standard RS422A differential type line driver
phase	5/12/24 V DC (2–5 mA)	
signal level		
Max. counting frequency	kHz 200	500
Counting range	32 bits + sign (binary), -2147483648—+2147483647	32 bits + sign (binary), -2147483648—+2147483647
Max. counting speed	kHz 200, 100 or 10	500, 200, 100 or 10
Counting functions	UP/DOWN preset counter and ring counter	
Connection terminal	40-pin connector	40-pin connector
Number of occupied I/O points	16	16
Internal current consumption	mA 310	360
Dimensions (WxHxD)	mm 28.5x90x95	28.5x90x95
Order information	Art. no. 238097	238098

Interface modules

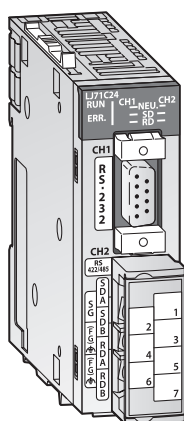

Data exchange with peripheral devices

These modules enable communication with peripheral devices via a standard serial interface.

The LJ71C24 provides one RS232 and one RS422/485 interface and the LJ71C24-R2 provides two RS232 interfaces.

- Maximum transmission speed of 230.4 kbps
- Quick connection using pre-defined protocols included in GX Works2
- Easy to define custom protocols
- Enhanced debugging and support functions

Specifications	LJ71C24	LJ71C24-R2
Interface type	channel 1 RS232-compliance (D-Sub 9P female)	RS232-compliance (D-Sub 9P female)
channel 2	RS422/485-compliance (2-piece terminal block)	RS232-compliance (D-Sub 9P female)
Communications mode	Full duplex/half duplex	
Synchronisation	Start-stop synchronization method	
Data transfer	rate bps 50–230400 (channel 1 only) 115200 (channel 1+2 simultaneously)	
distance	m RS232: 15; RS422/485: 1200	15
Max. no of stations in a multidrop network	No restrictions/64	No restrictions/64
Data format	1 start bit, 7 or 8 data bits, 1 or 0 parity bits, 1 or 2 stop bits	
1 or 2 stop bits	RS232 enabled, RS422/485 disabled	
Error detection	Parity check, checksum	
DTR/DSR and RS/CD control	RS232 enabled, RS422/485 disabled	
CD signal control	RS232 enabled, RS422/485 disabled	
X ON/X OFF (DC1/DC3), DC2/DC4	RS232 enabled, RS422/485 enabled	
Number of occupied I/O points	32	32
Internal current consumption	mA 390	260
Dimensions (WxHxD)	mm 28.5x90x95	28.5x90x95
Order information	Art. no. 238093	238094

CC-Link/CC-Link IE Field modules

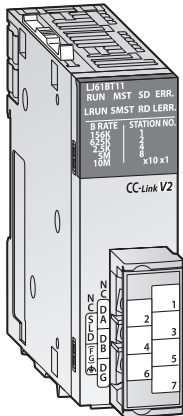

The gateway to CC-Link

CC-Link network enables the controlling and monitoring of decentralized I/O modules at the machine. The CC-Link master/slave module LJ61BT11 makes the MELSEC L series fully compatible with CC-Link.

With a large selection of CC-Link open network compatible devices, constructing a control system is easy.

Even applications requiring vast amounts of data transmissions can be satisfied because CC-Link Version 2 is supported.

- Can be used as Master or Local station
- A huge selection of device types using CC-Link can be connected.
- With the transmission speed auto-tracking function local stations do not require transmission speed setting
- Up to 8192 addressable remote I/O points
- Maximum transmission speed of 10 Mbps
- Standby master station function

Specifications		LJ61BT11
Module type		Master/Slave
Max. no. of connected stations		64
Max. overall cable distance	m	1200 (without repeater)
No. of occupied stations		1–4 stations
Max. number of link points	per system per station	2048 (8192)* 32
Transmission speed		156 kbps/625 kbps/2.5 Mbps/5 Mbps/10 Mbps
Transmission path		Bus (RS485)
Number of occupied I/O points		32
Internal current consumption	mA	460
Dimensions (WxHxD)	mm	25.5x90x118
Order information	Art. no.	238099

* Link points in remote net ver. 2 mode or remote net additional mode

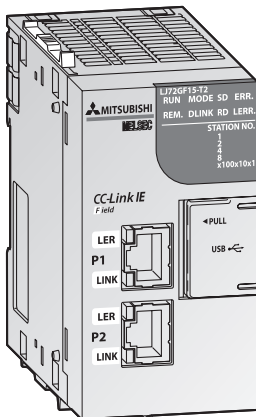

CC-Link IE field network head module

MELSEC L series I/O and intelligent function modules can be connected to the remote I/O head module without a dedicated CPU. There are many benefits to using intelligent device stations including reduced CPU and wiring costs, great flexibility in selecting I/O and intelligent function modules, and compact unit size.

- Intelligent device station
- Up to 2048 addressable remote I/O points
- Maximum transmission speed of 1 GB/s
- RAS functions (Reliability, Availability, Serviceability) for system monitor, remote RESET and self diagnostics
- A huge selection of CC-Link compatible devices can be connected.

Specifications		LJ72GF15-T2
Module type		Intelligent device station
Max. no. of connected stations		120
Max. overall cable distance	m	12000 (with 120 slave stations connected)
Max. station to station distance	m	100
Max. number of link points	per network per station	16384 2048
Transmission speed		1 Gbps
Transmission path		Star, line, mixed star and line, ring topology
Number of occupied I/O points		—
Internal current consumption	mA	1000
Dimensions (WxHxD)	mm	50x90x95
Order information	Art. no.	238100

Ethernet modul

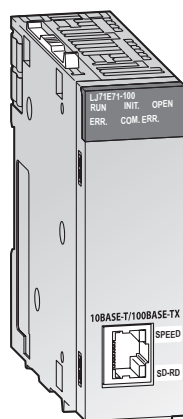

In addition to the build-in Ethernet port of the CPU module the L71E71-100 offers a solution for a second Ethernet network to collect or change PLC data, monitor CPU module operation, control status and transfer any data by TCP/IP or UDP/IP communication. The Web function allows to monitor and control the PLC via a web browser.

The Ethernet module has also the capability of sending and receiving of e-mails to and from a connected device in a remote location via the Internet. E-mails can be sent/received through the CPU module by special instructions. The CPU module can receive/send up to 6K-word data from/to a personal computer or other E71 modules as an e-mail attachment or can send up to 960-word data to a personal computer or portable terminal as the main text of an e-mail.

The other possibility is E-mail sending using the programmable controller CPU monitoring function. Notification conditions (CPU module status or device values) that have been set using parameters are regularly monitored. When the conditions are met, up to 960-word data can be sent as the main text of an e-mail or as attachment.

- Web function
- Communications via MC protocol, fixed buffer and random access buffer
- Up to 960 data words per query are available
- Sending and receiving data via e mail
- Up to 16 communications lines can be opened for concurrent data communications
- Prevention of unauthorized access through a remote password

Specifications		L71E71-100
Communication mode		Full-duplex/half-duplex
No. of simultaneous open connections		16
Fixed buffer communication		1 k words x 16
Random access buffer		6 k words x 1
E-mail	attachement	6 k words x 1
	main text	960 k words x 1
Communication with mail server		SMTP, POP3
Connector		RJ45
Transmission speed		100 Mbps, 10 Mbps
Max. segment length	m	100
Cable		CAT 5 or higher
Internal current consumption (5 V DC)	A	0.6
Number of occupied I/O points		32
Dimensions (WxHxD)	mm	28.5x95x90
Order information		Art. no. 263072

Serial communications adapters

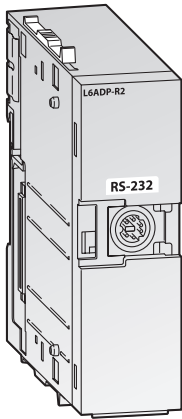

RS232 interface adapter

The L6ADP-R2 provides a RS232 interface for serial communication with the MELSEC L series PLC.

Specifications		L6ADP-R2
Application		Serial connection, e.g. GT10 Terminals
Power supply		MELSEC L series Backplane
Max. transfer rate	kbit/s	115.2
Number of occupied I/O points		—
Internal current consumption	mA	20
Dimensions (WxHxD)	mm	28.5x90x95
Order information	Art. no.	238059

4

Modular PLCs

End cover

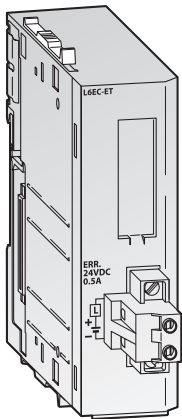

END cover with error terminal

This end cover can be used instead of the standard end cover which comes with the CPU in the basic equipment.

The optional L6EC-ET end cover has a single relay output for error notification.

Specifications		L6EC-ET	L6EC
Application		Error notification via relay output	Standard end cover
Output		Screw terminal	—
Max. switching load	A	0.5 (24 V DC)	—
Dimensions (WxHxD)	mm	28.5x90x112.5	13x90x95
Order information	Art. no.	238062	249151

Note: MELSEC L series CPU modules are supplied with a standard End Cover L6EC.

Branch/extension module

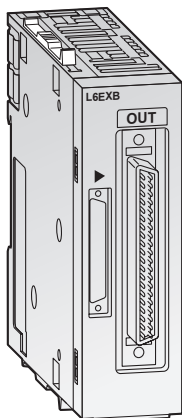

Extension for MELSEC L series PLC

With a L6EXB branch module, which is connected to the CPU, and with up to two (L02CPU, L02CP-P) or up to three extension modules (L26CPU-BT, L26CUPBT), a MELSEC L series PLC can be extended to max. 30/40 modules.

Specifications		L6EXB [Branch module]	L6EXE [Extension module]
Internal power consumption (5 V DC)	A	0.08	0.08
Weight	kg	0.12	0.13
Dimensions (WxHxD)	mm	28.5x90x95	28.5x90x95
Order information	Art. no.	247227	247226

Accessories

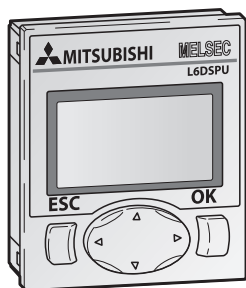

Display module

The display module allows to check the system status and to make setting changes directly from the display, which will be built-in directly into the CPU.

Error status is clearly identified and troubleshooting and error investigation can be performed all without the need for any connections or engineering software.

Specifications	L6DSPU	
Application	Displaying menus, time, and monitoring data. Setting of values and parameters.	
Display	16 letters x 4 lines	
Power supply	From CPU	
Display	LCD with backlight (green/red)	
Language	English, Japanese	
Dimensions (WxHxD)	mm	45x50x17.3
Order information	Art. no.	238058



SD memory card

The SD memory card allows quick and easy back-up of the CPU program and parameters. It can also be used to hold data captured with the data logging function.

The card is selectively available with 2 GB and 4 GB capacity.

Specifications	L1MEM-2GBSD	L1MEM-4GBSD
Card type	SD memory card	SDHC memory card
Memory capacity	2 GB	4 GB
Order information	Art. no. 238060	238061

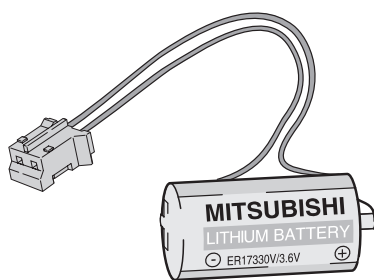

Backup battery

Two different batteries as replacement for the built-in back-up battery are available for the L series CPU.

Specifications	Q6BAT	Q7BAT	Q7BAT-SET
Voltage	V 3.0	3.0	3.0
Capacity	mAh 1800	5000	5000
Scope of delivery	Battery	Battery	Battery plus holder
Order information	Art. no. 130376	204127	204128

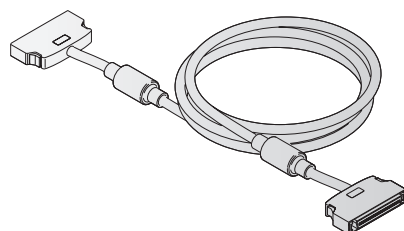

Extension cables

These cables connect a branch module with one or two extension modules.

Specifications	LC06E	LC10E	LC30E
Cable length	m 0.6	1.0	3.0
Weight	kg 0.19	0.23	0.45
Order information	Art. no. 247228	247229	247230

Compact PLCs

FX family

Micro PLCs have opened up the world of opportunities in Industrial Automation due to their small size and low cost. Now many applications that were never previously considered can benefit – from barriers to security systems and a host of others. The FX family is the world's best selling cost-effective 'brick' type PLCs, consisting of six independent but compatible product ranges.

Depending on your application and control needs, you can choose from the small, attractively priced, "stand-alone" FX1S series or the more powerful FX3G, FX3GC, FX3GE, FX3U and FX3UC series.

All FX series PLCs can be expanded to adapt them to the changing needs of your installations and applications.

Network integration is also supported, making it possible for your FX controllers to communicate with other PLCs, controllers and HMIs.

Equipment features

Communications modules

Interface modules with RS232/RS422/RS485 or USB for the connection of peripherals and PLC-PLC links.

Network modules for Ethernet, Profibus DP, CC-Link, DeviceNet, CANopen, Ethernet, Modbus RTU/ASCII and for the configuration of proprietary Mitsubishi Electric networks.

Positioning modules

High-speed counter modules with support for the connection of incremental rotary transducers and positioning modules for servo and stepping motor drives.

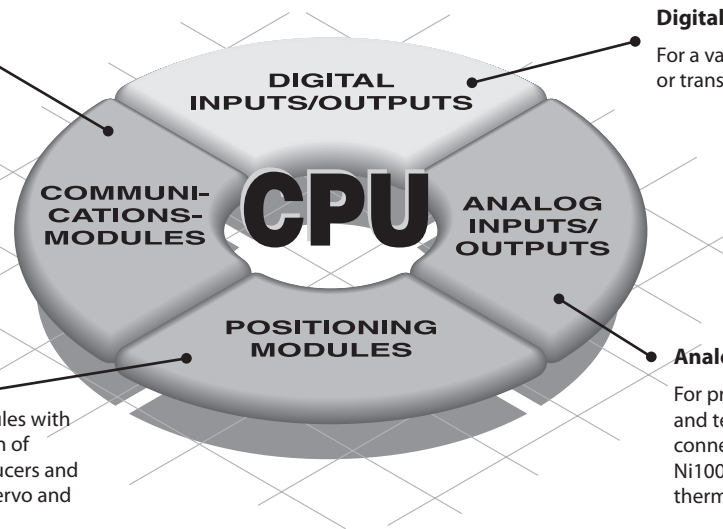

Digital input/output modules

For a variety of signal levels with relay or transistor switches.

Analog input/output modules

For processing current/voltage signals and temperature registration with a direct connection option for Pt100, Pt1000 and Ni1000 resistance thermometers and thermocouples.

Expandability and power

The MELSEC FX family is highly flexible, enabling fast and efficient configuration and programming for the application at hand.

It is the ideal choice, no matter whether you need to install a simple control application requiring up to 30 I/Os (FX1S) or a demanding, complex system with up to 384 I/O points (FX3U/FX3UC).

The capacity of the CPUs of the FX family can be expanded with memory cassettes. Non-volatile memory cassettes with a capacity of up to 64 k program steps are available for reliable, long-term storage of your PLC projects.

In addition to the other advantages this enables you to switch programs at very short notice, simply by replacing a cassette.

There are six series in the FX family, each of which is designed for a different application profile. The diagram highlights the capabilities of each FX PLC type.

The Alpha can also be expanded to provide a small increase in I/O, analogue output, temperature input or networking capability.

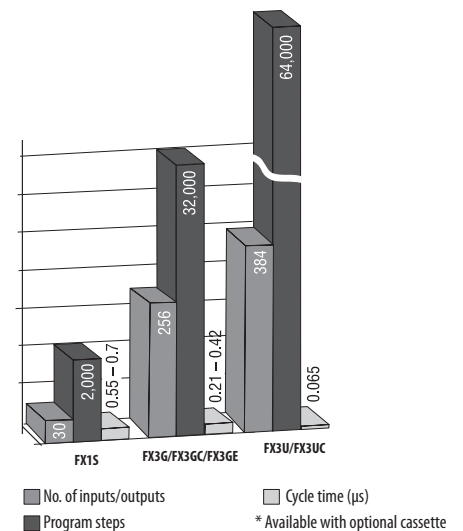

Micro controllers Alpha series

Alpha fills the gap between traditional relays and timers and a PLC. Offering functionality, reliability and flexibility but without the worry of cost of overheads. Alpha is the perfect

maintenance product, and yet can adequately control a new process from the start.

The Alpha 2 can process up to 200 function blocks in a single program, and every single

function (timers, counters, analog signal processing, calendar, clock etc.) can be used as many times as you need in all your programs.

What components are required for an FX PLC system?

A basic FX PLC system can consist of a stand-alone base unit, with the functionality and I/O range increased by adding extension I/O and special function modules. The following section provides an overview of options available.

Base units

The entire FX PLC range can be AC or DC powered with a mix of input and output styles. The PLCs can be programmed with the user friendly GX Works2 programming software, allowing programs to be transferred between different FX PLCs. All PLC base units include an integrated real time clock.

Base units are available with different I/O configurations from 10 to 128 points but can be expanded to 384 points depending upon the FX range selected.

Extension boards

Except for the FX3GC and FX3UC series, extension adapter boards can be installed directly into the base unit and therefore do not require any additional installation space. For a small number of I/O (2 to 4) an extension adapter boards can be installed directly into the FX1S, FX3G, FX3GE or FX3U controller. Interface adapter boards can also provide the FX PLC with additional RS232, RS422, RS485 or USB interfaces. To connect adapter modules (e.g. Ethernet module) a communication adapter has to be installed (except FX3UC).

Extension I/O modules

Unpowered and powered extension I/O modules can be added to the FX3G, FX3GC, FX3GE, FX3U and FX3UC PLCs.

For expansion modules powered by the base unit, the power consumption has to be calculated as the 5 V DC bus can only support a limited number of expansion I/O (for further details please refer to next page – calculation of the power consumption).

Special function modules

A wide variety of special function modules are available for the FX3G, FX3GC, FX3GE, FX3U and FX3UC PLCs. They cover networking functionality, analog control, pulse train outputs, data logging function and temperature inputs.

Memory extension and operator terminals

Each FX family base unit (except FX3GC) can be equipped with a memory cassette. The programming unit interface enables the connection of programming tools like PC and hand held programming units as well as graphical operator terminals.

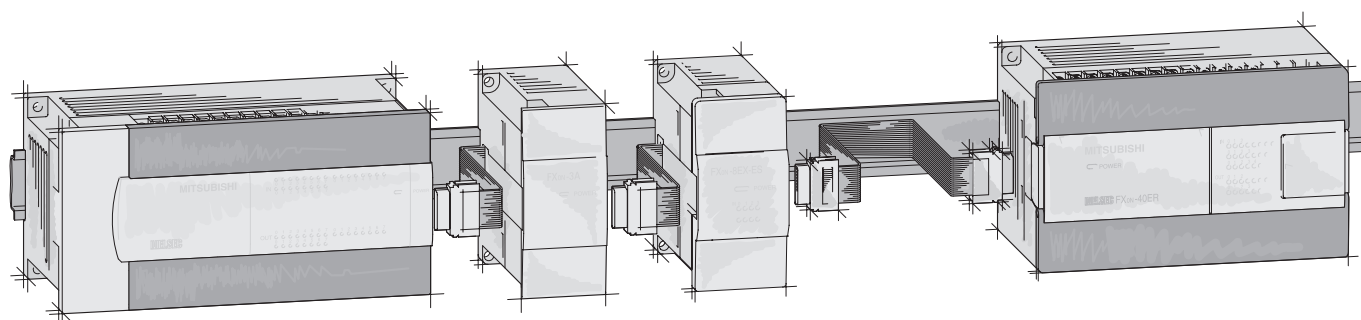

Expansion possibilities		ALPHA 2	FX1S	FX3G	FX3GC	FX3GE	FX3U	FX3UC
Extensions for inside PLC installation	Digital	●	●	—	—	—	—	—
	Analog	●	●	●	—	●	—	—
Extension modules (installation outside the PLC)	Digital	—	—	●	●	●	●	●
	Analog	—	—	●	●	●	●	●
	Temperature	●	—	●	●	●	●	●
	Ethernet	—	●	●	●	●	●	●
	CC-Link	—	—	●	●	●	●	●
	CANopen	—	—	●	●	●	●	●
	Profibus DP	—	—	●	●	●	●	●
	DeviceNet	—	—	●	●	●	●	●
	Modbus RTU/ASCII	—	—	●	●	●	●	●
	SSCNET	—	—	—	—	—	●	●
	J1939	—	—	●	●	●	●	●
	RS232	●	●	●	—	●	●	—
	RS422	—	●	●	—	●	●	—
Communications boards	RS485	—	●	●	—	●	●	—
	USB	—	—	—	—	—	●	—
Communications modules	RS232	—	●	●	●	●	●	●
	RS485	—	●	●	●	●	●	●
Dedicated function modules	High speed counter	—	—	—	—	—	●	●
	Positioning	—	—	—	—	—	●	●
Memory cassettes	●	●	●	—	●	●	●	●
External display	—	●	●	—	—	●	●	—

Calculation of the power consumption

The power consumption figures on the 5 V DC bus for the special function modules are shown in the specifications tables on the following pages.

The maximum permissible currents on the 5 V DC and 24 V DC bus are shown in the table below.

Modules	Max. current	
	5 V bus	24 V bus
FX3G-14/24M□-ES(ESS)	—	400 mA
FX3G-40/60M□-ES(ESS)	—	400 mA
FX3U-16/32M□-ES(ESS)	500 mA	400 mA
FX3U-48~128M□-ES(ESS)	500 mA	600 mA
FX3UC-16MT/D(DSS)	600 mA	—
FX3UC-32MT/D(DSS)	560 mA	—
FX3UC-64MT/D(DSS)	480 mA	—
FX3UC-96MT/D(DSS)	400 mA	—

The residual currents for the 24 V DC service voltage at different input/output configurations are shown in the tables on the right.

A maximum of 256 I/Os are possible for FX3U/ FX3UC (128 I/Os for FX3G).

Max. residual current values (in mA) for FX3U-16M□/E□□ through FX3U-32M□/E□□ for the permissible configuration

Number of additional outputs	40	25											
	32	100	50	0									
	24	175	125	75	25								
	16	250	200	150	100	50	0						
	8	325	275	225	175	125	75	25					
0	400	350	300	250	200	150	100	50	0				
	0	8	16	24	32	40	48	56	64				
	Number of additional inputs												

Max. residual current values (in mA) for FX3U-48M□/E□□ through FX3U-128M□/E□□ for the permissible configuration

Number of additional outputs	64	0														
	56	75	25													
	48	150	100	50	0											
	40	225	175	125	75	25										
	32	300	250	200	150	100	50	0								
	24	375	325	275	225	175	125	75	25							
	16	450	400	350	300	250	200	150	100	50	0					
	8	525	475	425	375	325	275	225	175	125	75	25				
	0	600	550	500	450	400	350	300	250	200	150	100	50	0		
	0	8	16	24	32	40	48	56	64	72	80	88	96			
	Number of additional inputs															

5 Compact PLCs

Sample calculations

The tables below and on the right show different examples for sample power calculation for a PLC system.

The current values for the special function modules can be found in the specifications on the following pages.

Comparison with the current value tables show that the calculated figures for the 5 V bus lie within the allowable ranges.

In the example below all units can be supplied sufficiently with the internal 24 V power supply.

Module	No.	24 V DC calculation		5 V DC calculation	
		Current/module	Calculation	Current/module	Total current
FX3U-80MR/ES	1	600 mA	+600 mA	+500 mA	+500 mA
FX3U-4AD	2	90 mA	-180 mA	110 mA	-220 mA
FX3U-4DA	2	160 mA	-320 mA	120 mA	-240 mA
FX3U-ENET	1	240 mA	-240 mA	—	—
			-140 mA !!!		500-460 mA
				Result:	40 mA (OK!)

An external 24 V power supply has to be added in the example above.

Module	No.	Number of I/Os			24 V DC calculation		5 V DC calculation		
		X	Y	X/Y	Total ①	Total current ②	Current/module	Total current	
FX3U-48MR/ES	1	24	24	—	X = 8 Y = 24 →	+325 mA	500 mA	+500 mA	
FX2N-16EYR-ES/UL	1	—	16	—			—	0 mA	
FX2N-8EX-ES/UL	1	8	—	—			—	0 mA	
FX2N-8EYR-ES/UL	1	—	8	—			—	0 mA	
FX3U-4AD-PT-ADP	1	—	—	—			-50 mA	30 mA	-15 mA
						+275 mA (OK!)		+485 mA (OK!)	
FX2N-32ER-ES/UL	1	16	16	—	X = 16 Y = 0 →	+150 mA residual current for extension unit FX2N-32ER-ES/UL	690 mA	+690 mA	
FX2N-16EX-ES/UL	1	16	—	—			—	0 mA	
FX2N-10PG	1	—	—	8			0 mA	120 mA	-120 mA
FX2N-32CCL	1	—	—	8			-50 mA	130 mA	-130 mA
						+100 mA (OK!)		+440 mA (OK!)	

① Total no. of I/Os which are connected to a base unit to calculate the max. residual current values (see tables)

② see tables above (max. residual current values)

FX1S series

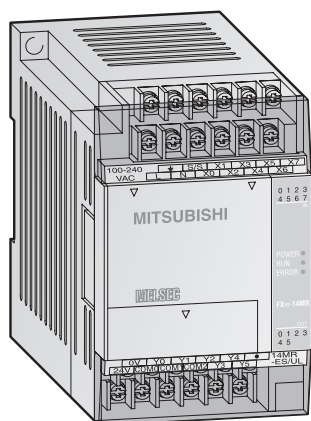

The FX1S series base units are available with 10 to 30 input/output points. It is possible to choose between relay and transistor output types.

- Integrated power supply (AC or DC powered)
- Maintenance-free EEPROM memory
- Ample memory capacity (2000 steps) and device ranges
- High-speed operations
- Incorporated positioning control
- Integrated real-time clock

- System upgrades by exchangeable interface and I/O adapter boards for direct fitting into the base unit
- LEDs for indicating the input and output status
- Standard programming unit interface
- User-friendly programming systems, including IEC 61131-3 (EN 61131-3) compatible programming software, HMI and hand-held programming units

Base units with 10–14 I/Os

Specifications	FX1S-10 MR-DS	FX1S-10 MR-ES/UL	FX1S-10 MT-DSS	FX1S-14 MR-DS	FX1S-14 MR-ES/UL	FX1S-14 MT-DSS
Max. number inputs/outputs	10	10	10	14	14	14
Power supply	24 V DC	100–240 V AC	24 V DC	24 V DC	100–240 V AC	24 V DC
Integrated inputs	6	6	6	8	8	8
Integrated outputs	4	4	4	6	6	6
Output type	Relay	Relay	Transistor (source)	Relay	Relay	Transistor (source)
Power consumption	W	6	19	6	6.5	19
Weight	kg	0.22	0.3	0.22	0.3	0.22
Dimensions (WxHxD)	mm	60x90x49	60x90x75	60x90x49	60x90x75	60x90x49
Order information	Art. no.	141240	141243	141246	141247	141248

Base units with 20–30 I/Os

Specifications	FX1S-20 MR-DS	FX1S-20 MR-ES/UL	FX1S-20 MT-DSS	FX1S-30 MR-DS	FX1S-30 MR-ES/UL	FX1S-30 MT-DSS
Max. number inputs/outputs	20	20	20	30	30	30
Power supply	24 V DC	100–240 V AC	24 V DC	24 V DC	100–240 V AC	24 V DC
Integrated inputs	12	12	12	16	16	16
Integrated outputs	8	8	8	14	14	14
Output type	Relay	Relay	Transistor (source)	Relay	Relay	Transistor (source)
Power consumption	W	7	20	7	8	21
Weight	kg	0.3	0.4	0.3	0.35	0.45
Dimensions (WxHxD)	mm	75x90x49	75x90x75	75x90x49	100x90x49	100x90x75
Order information	Art. no.	141251	141252	141254	141255	141256

FX3G series

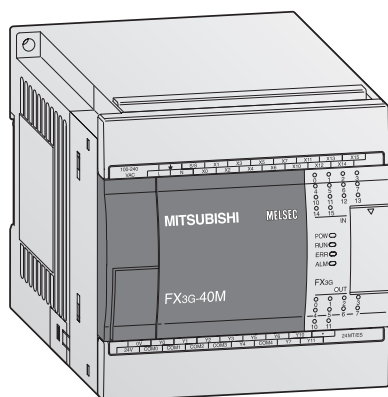

The FX3G series base units are available with 14 to 60 input/output points .

It is possible to choose between relay and transistor output types.

- Integrated USB interface for communication between PLCs and PC
- Integrated serial interface for communication between PCs and HMI
- LEDs for indicating the input and output status
- Detachable terminal blocks for all units
- Slot for memory cassettes
- Integrated real-time clock
- Integrated positioning control
- Exchangeable interface and extension adapters for direct mounting into a base unit
- Expandable with digital I/O modules, special function modules and ADP modules
- User-friendly programming systems, including IEC 61131-3 (EN 61131-3) compatible programming software, HMIs and hand-held programming units

Base units with 14–24 I/Os

Specifications	FX3G-14 MR/ES	FX3G-14 MT/ESS	FX3G-14 MR/DS	FX3G-14 MT/DSS	FX3G-24 MR/ES	FX3G-24 MT/ESS	FX3G-24 MR/DS	FX3G-24 MT/DSS
Integrated inputs/outputs	14	14	14	14	24	24	24	24
Power supply	100–240 V AC	100–240 V AC	24 V DC	24 V DC	100–240 V AC	100–240 V AC	24 V DC	24 V DC
Integrated inputs	8	8	8	8	14	14	14	14
Integrated outputs	6	6	6	6	10	10	10	10
Output type	Relay	Transistor (source)*	Relay	Transistor (source)*	Relay	Transistor (source)*	Relay	Transistor (source)*
Power consumption W	31	31	19	19	32	32	21	21
Weight kg	0.50	0.50	0.50	0.50	0.55	0.55	0.55	0.55
Dimensions (WxHxD) mm	90x90x86	90x90x86	90x90x86	90x90x86	90x90x86	90x90x86	90x90x86	90x90x86
Order information	Art. no. 231466	231470	231474	231478	231467	231471	231475	231479

Base units with 40–60 I/Os

Specifications	FX3G-40 MR/ES	FX3G-40 MT/ESS	FX3G-40 MR/DS	FX3G-40 MT/DSS	FX3G-60 MR/ES	FX3G-60 MT/ESS	FX3G-60 MR/DS	FX3G-60 MT/DSS
Integrated inputs/outputs	40	40	40	40	60	60	60	60
Power supply	100–240 V AC	100–240 V AC	24 V DC	24 V DC	100–240 V AC	100–240 V AC	24 V DC	24 V DC
Integrated inputs	24	24	24	24	36	36	36	36
Integrated outputs	16	16	16	16	24	24	24	24
Output type	Relay	Transistor (source)*	Relay	Transistor (source)*	Relay	Transistor (source)*	Relay	Transistor (source)*
Power consumption W	37	37	25	25	40	40	29	29
Weight kg	0.70	0.70	0.70	0.70	0.85	0.85	0.85	0.85
Dimensions (WxHxD) mm	130x90x86	130x90x86	130x90x86	130x90x86	175x90x86	175x90x86	175x90x86	175x90x86
Order information	Art. no. 231468	231472	231476	231480	231469	231473	231477	231481

* Units with sink transistor outputs on request.

FX3GE series

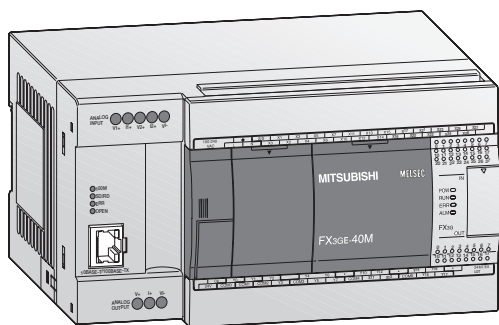

The FX3GE series base units are available with 24 or 40 input/output points.

All base units are equipped with relay outputs.

- Integrated analog input (2ch)
- Integrated analog output (1ch)
- Integrated Ethernet interface
- Integrated USB interface for communication between PLC and PC
- Integrated serial interface for communication between PLC and HMI
- LEDs for indicating the input and output status

- Connection of inputs and outputs via terminals.
- Slot for memory cassettes
- Integrated positioning control
- Expandable with special function modules and ADP modules
- User-friendly programming systems, including IEC 61131-3 (EN 61131-3) compatible programming software, HMIs and hand-held programming units

Base units with 24/40 I/Os

Specifications	FX3GE-24MR/ES	FX3GE-40MR/ES
Integrated inputs/outputs	24	40
Power supply	100–240 V AC	100–240 V AC
Integrated inputs	14	24
Integrated outputs	10	16
Output type	Relay	Relay
Power consumption	W 32	37
Weight	kg 0.6	0.8
Dimensions (WxHxD)	mm 130x90x86	175x90x86
Order information	Art. no. 264869	264870

FX3GC series

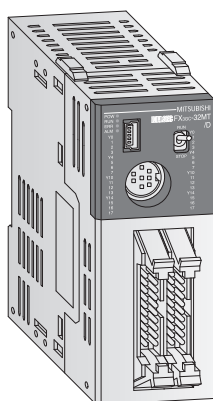

The FX3GC series base units are available with 32 input/output points.

All base units are equipped with transistor outputs.

- Integrated USB interface for communication between PLC and PC
- Integrated serial interface for communication between PLC and HMI
- LEDs for indicating the input and output status
- Connection of inputs and outputs via connectors.
- Integrated positioning control

- Expandable with digital I/O modules, special function modules and ADP modules
- User-friendly programming systems, including IEC 61131-3 (EN 61131-3) compatible programming software, HMIs and hand-held programming units

Base units with 32 I/Os

Specifications	FX3GC-32MT/D	FX3GC-32MT/DSS
Integrated inputs/outputs	32	32
Power supply	24 V DC	24 V DC
Integrated inputs	16	16
Integrated outputs	16	16
Output type	Transistor (sink type)	Transistor (source type)
Power consumption	W 8	8
Weight	kg 0.2	0.2
Dimensions (WxHxD)	mm 34x90x87	34x90x87
Order information	Art. no. 251545	251546

FX3U series

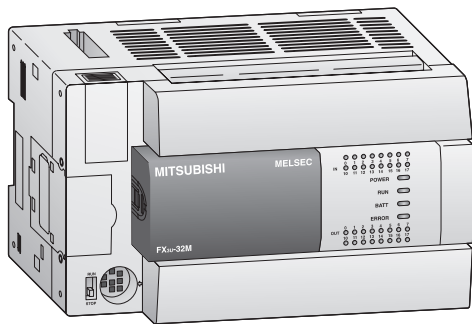

The FX3U series base units are available with 16, 32, 48, 64, 80 or 128 input/output points expandable to 384 points.

Models are available for selection with relay or transistor outputs.

- Integrated serial interface for communication between PCs and HMI
- Integrated positioning control
- Exchangeable interface modules for direct mounting into a base unit
- LEDs for indicating the input and output status
- Slot for memory cassettes
- Integrated real-time clock
- Expandable with digital I/O modules, special function modules and ADP modules
- User-friendly programming systems, including IEC 61131-3 (EN 61131-3) compatible programming software, HMIs and hand-held programming units

Base units with 16–128 I/Os

Specifications	FX3U-16 MR/ES	FX3U-32 MR/ES	FX3U-32 MS/ES	FX3U-48 MR/ES	FX3U-64 MR/ES	FX3U-64 MS/ES	FX3U-80 MR/ES	FX3U-128 MR/ES
Integrated inputs/outputs	16	32	32	48	64	32	80	128
Power supply	100–240 V AC	100–240 V AC	100–240 V AC	100–240 V AC	100–240 V AC	100–240 V AC	100–240 V AC	100–240 V AC
Integrated inputs	8	16	16	24	32	32	40	64
Integrated outputs	8	16	16	24	32	32	40	64
Output type	Relay	Relay	Triac	Relay	Relay	Triac	Relay	Relay
Power consumption W	30	35	35	40	45	45	50	65
Weight kg	0.6	0.65	0.65	0.85	1.0	1.0	1.2	1.8
Dimensions (WxHxD) mm	130x90x86	150x90x86	150x90x86	182x90x86	220x90x86	220x90x86	285x90x86	350x90x86
Order information	Art. no. 231486	231487	237263	231488	231489	237264	231490	231491

Specifications	FX3U-16 MT/ESS	FX3U-32 MT/ESS	FX3U-48 MT/ESS	FX3U-64 MT/ESS	FX3U-80 MT/ESS	FX3U-128 MT/ESS
Integrated inputs/outputs	16	32	48	64	80	128
Power supply	100–240 V AC	100–240 V AC	100–240 V AC	100–240 V AC	100–240 V AC	100–240 V AC
Integrated inputs	8	16	24	32	40	64
Integrated outputs	8	16	24	32	40	64
Output type	Transistor (source type)*	Transistor (source type)*	Transistor (source type)*	Transistor (source type)*	Transistor (source type)*	Transistor (source type)*
Power consumption W	30	35	40	45	50	65
Weight kg	0.6	0.65	0.85	1.0	1.2	1.8
Dimensions (WxHxD) mm	130x90x86	150x90x86	182x90x86	220x90x86	285x90x86	350x90x86
Order information	Art. no. 231492	231493	231494	231495	231496	231497

Specifications	FX3U-16 MR/DS	FX3U-32 MR/DS	FX3U-48 MR/DS	FX3U-64 MR/DS	FX3U-80 MR/DS
Integrated inputs/outputs	16	32	48	64	80
Power supply	24 V DC	24 V DC	24 V DC	24 V DC	24 V DC
Integrated inputs	8	16	24	32	40
Integrated outputs	8	16	24	32	40
Output type	Relay	Relay	Relay	Relay	Relay
Power consumption W	25	30	35	40	45
Weight kg	0.6	0.65	0.85	1.0	1.2
Dimensions (WxHxD) mm	130x90x86	150x90x86	182x90x86	220x90x86	285x90x86
Order information	Art. no. 231498	231499	231500	231501	231502

Specifications	FX3U-16 MT/DSS	FX3U-32 MT/DSS	FX3U-48 MT/DSS	FX3U-64 MT/DSS	FX3U-80 MT/DSS
Integrated inputs/outputs	16	32	48	64	80
Power supply	24 V DC	24 V DC	24 V DC	24 V DC	24 V DC
Integrated inputs	8	16	24	32	40
Integrated outputs	8	16	24	32	40
Output type	Transistor (source type)*	Transistor (source type)*	Transistor (source type)*	Transistor (source type)*	Transistor (source type)*
Power consumption W	25	30	35	40	45
Weight kg	0.6	0.65	0.85	1.0	1.2
Dimensions (WxHxD) mm	130x90x86	150x90x86	182x90x86	220x90x86	285x90x86
Order information	Art. no. 231503	231504	231505	231506	231507

* Units with sink type transistor outputs on request.

FX3UC series

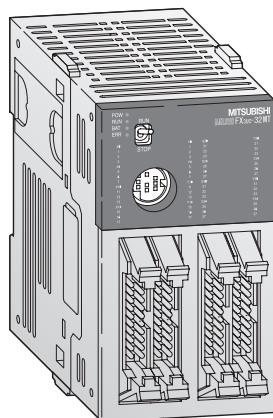

The base units of the FX3UC series are available in versions with 16, 32, 64 or 96 inputs/outputs (expandable to 384 I/Os).

The units are available with transistor outputs only.

- Integrated serial interface for communication between PCs and HMI
- Same instruction set as FX3U
- Integrated positioning control
- Very compact dimensions
- LEDs for indicating the input and output status

- Slot for memory cassette
- Adapter modules and system cabling sets available for units with ribbon cable connectors
- Expandable with digital I/O modules, special function modules and ADP modules
- User-friendly programming systems, including IEC 61131-3 (EN 61131-3) compatible programming software, HMIs and hand-held programming units

Base units with 16–96 I/Os

Specifications	FX3UC-16 MT/DSS	FX3UC-16 MR/D-T	FX3UC-16 MR/DS-T	FX3UC-32 MT/DSS	FX3UC-64 MT/DSS	FX3UC-96 MT/DSS	
Integrated inputs/outputs	16	16	16	32	64	96	
Power supply	24 V DC (+20 %, -15 %)	24 V DC	24 V DC	24 V DC (+20 %, -15 %)	24 V DC (+20 %, -15 %)	24 V DC (+20 %, -15 %)	
Integrated inputs	8	8	8	16	32	48	
Integrated outputs	8	8	8	16	32	48	
Output type	Transistor (source type)*	Relay	Relay	Transistor (source type)*	Transistor (source type)*	Transistor (source type)*	
Power consumption	W	6	6	8	11	14	
Weight	kg	0.2	0.25	0.25	0.3	0.35	
Dimensions (WxHxD)	mm	34x90x74	34x90x74	34x90x74	59.7x90x74	85.4x90x74	
Order information	Art. no.	231508	237305	237306	231509	231510	231511

*Units with sink type transistor outputs on request.

System cabling

A choice of terminal blocks with screw or spring terminals are available for easy wiring of the FX3UC modules with standard ribbon cable connectors.

For detailed information about the terminal blocks, please refer to the FX Family catalogue.

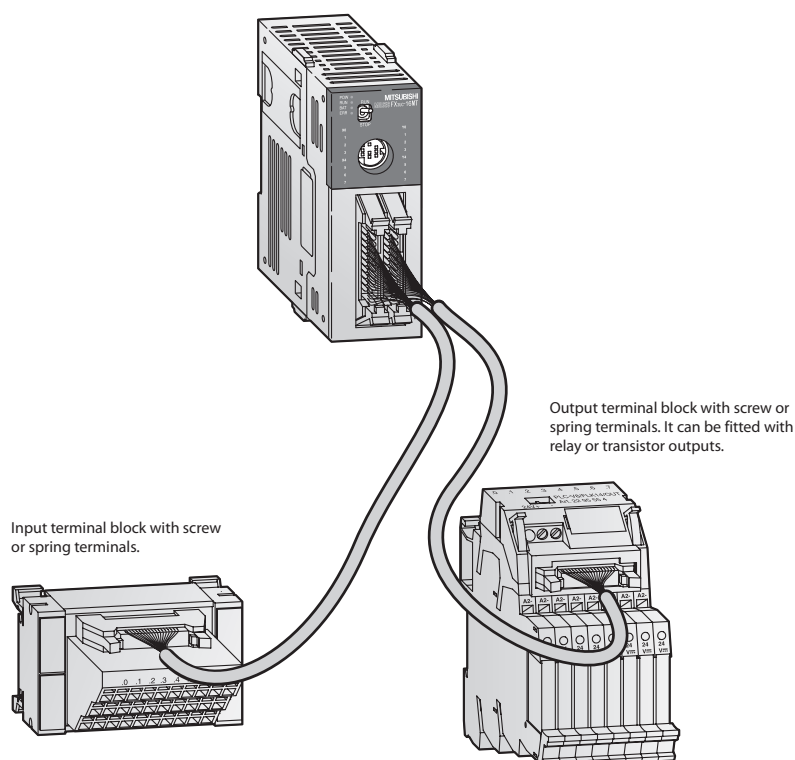

Input terminal block with screw or spring terminals.

Output terminal block with screw or spring terminals. It can be fitted with relay or transistor outputs.

Expandability and functionality

Additional special function and expansion modules are available that make it possible to extend the capacity of the PLC system. There are three basic categories of modules:

- Modules that occupy digital I/Os (connected on the right hand side of the base unit). These are the digital unpowered and powered extension units, as well as the special function modules.
- Communication and adapter modules that are connected to the left hand side of the base unit, for example FX3U-4AD-ADP and FX2NC-485ADP.
- Internal adapter boards for the FX1S, FX3G, FX3GE and the FX3U series. These expansion units are installed directly in the base unit and do not occupy any digital I/O.

Note: To connect special function modules or extension units of the FX0N/ FX2N/FX3U series to an FX3UC series base unit, an adapter FX2NC-CNV-IF or the power supply FX3UC-1PS-5V is required.

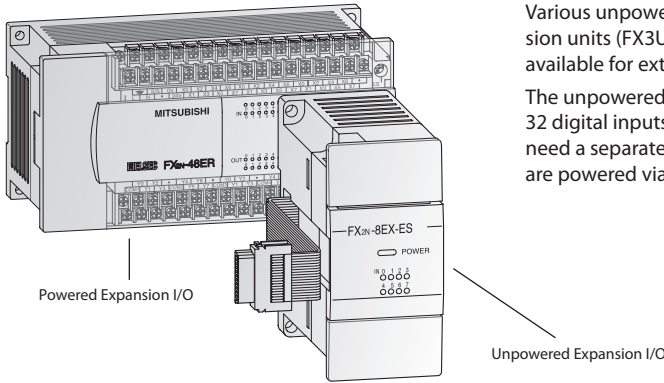

Various unpowered and powered extension units (FX3UC unpowered only) are available for extending the base units. The unpowered units contain 16 or 32 digital inputs/outputs max. and do not need a separate power supply, since they are powered via the system bus.

The powered extension units contain a larger number of inputs/outputs and an integrated power supply unit, to power the system bus and the digital inputs.

Specifications	POWERED					UNPOWERED				
	FX2N-32 ER-ES/UL	FX2N-48 ER-ES/UL	FX2N-8 ER-ES/UL	FX2N-8 EX-ES/UL	FX2N-8 EYR-ES/UL	FX2N-8 EYT-ESS/UL	FX2N-16 EX-ES/UL	FX2N-16 EYR-ES/UL	FX2N-16 EYT-ESS/UL	
Integrated inputs/outputs	32	48	8	8	8	8	16	16	16	
Application	FX3G and FX3U/FX3UC series base units									
Power supply AC range (+10%, -15%)	100–240 V	100–240 V	All modular extension blocks are supplied by the base unit.							
Integrated inputs	16	24	4	8	—	—	16	—	—	
Integrated outputs	16	24	4	—	8	8	—	16	16	
Output type	Relay	Relay	Relay	—	Relay	Transistor (source)**	—	Relay	Transistor (source)**	
Switching voltage (max.)	Generally for relay version: <240 V AC, <30 V DC; for transistor version: 5–30 V DC									
Max. output current per output	A	2	2	—	2	0.5	—	2	0.5	
per group *	A	8	8	—	8	0.8	—	8	1.6	
Related I/O points	32	48	16	8	8	8	16	16	16	
Dimensions (WxHxD)	mm	150x90x87	182x90x87	43x90x87	43x90x87	43x90x87	43x90x87	40x90x87	40x90x87	
Order information	Art. no.	65568	65571	166285	166284	166286	166287	65776	65580	65581

* This limitation applies only per reference terminal for each group. Please observe the terminal assignments for the group identification. ** Units with sink type transistor outputs on request.

Specifications	FX2NC-16 EX-T-DS	FX2NC-16 EYR-T-DS	FX2NC-16 EX-DS	FX2NC-16 EYT-DSS	FX2NC-32 EX-DS	FX2NC-32 EYT-DSS	
	Integrated inputs/outputs	16	16	16	16	32	32
Application	All FX3UC series base units						
Power supply	All modular extension units are supplied by the base unit.						
Integrated inputs	16	—	16	—	32	—	
Integrated outputs	—	16	—	16	—	32	
Output type	—	Relay	—	Transistor (source)**	—	Transistor (source)**	
Switching voltage (max.)	V	Generally for relay version: <240 V AC, <30 V DC; for transistor version: 5–30 V DC					
Max. output current per output	A	2	—	0.1/0.3 ①	—	0.1/0.3 ①	
per group *	A	4/8	—	0.8	—	0.8	
Max. switching power inductive load	VA	80	—	2.4/7.2 ②	—	2.4/7.2 ②	
lamp load	W	100	—	0.3/0.9 ③	—	0.3/0.9 ③	
Connection type	Removable screw terminal blocks		Ribbon cable connector		Ribbon cable connector		
Related I/O points	16	16	16	16	32	32	
Dimensions (WxHxD)	mm	20.2x90x89	24.2x90x89	14.6x90x87	14.6x90x87	26.2x90x87	
Order information	Art. no.	128152	128153	104503	104504	104505	104506

① for Y0 and Y1 = 0.3 A; all others 0.1 A ② 7.2 W for Y0 to Y3; all others 2.4 W ③ 0.9 W for Y0 to Y3; all others 0.3 W

* This limitation applies only per reference terminal for each group. Please observe the terminal assignments for the group identification. ** Units with sink type transistor outputs on request.

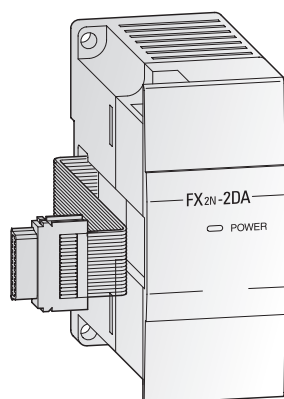

Analog output modules

The analog output modules provide the user with 2 to 4 analog outputs. The modules convert digital values from the FX3G, FX3GE, FX3U and FX3UC controller to the

analog signals required by the process. The modules can output both current and voltage signals.

Specifications	FX2N-2DA	FX2N-4DA	FX3U-4DA*
Analog channels	—	—	—
inputs	—	—	—
outputs	2	4	4
Analog output range	0—+10 V DC/0—+5 V DC/ 4—+20 mA	-10—+10 V DC/0—+20 mA/ 4—+20 mA	-10—+10 V DC/0—+20 mA/ 4—+20 mA
Resolution	2.5 mV/4 μ A (12 bit)	5 mV (10 bit)/20 μ A (11 bit + sign)	0.32 mV (15 bit + sign) 0.6 μ A (15 bit)
Fullscale overall accuracy	\pm 1 %	\pm 1 %	\pm 0.3–0.5 %**
Power supply	5 V DC 24 V DC	30 mA (from base unit) 85 mA	30 mA (from base unit) 200 mA
120 mA (from base unit) 160 mA			
Related I/O points	8	8	8
Dimensions (WxHxD)	mm 43x90x87	55x90x87	55x90x87
Order information	Art. no. 102868	65586	169509

* for FX3G/FX3U/FX3UC only **Dependent on the ambient temperature

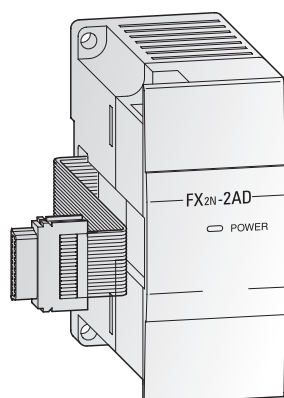

Analog input modules

The analog input modules provide the user with 2 to 8 analog inputs. The module converts analog process signals into digital values which are further processed

by the MELSEC FX3G, FX3GC, FX3GE, FX3U and FX3UC controller. The actual values or mean values over several measurements may be output.

Specifications	FX2N-2AD	FX2N-4AD	FX3U-4AD/FX3UC-4AD*	FX2N-8AD
Analog channels	2	4	4	8
inputs	—	—	—	—
outputs	—	—	—	—
Analog input range	0—+10 V DC/ 0—+5 V DC/ 0/4—+20 mA	-10—+10 V DC / -20—+20 mA/ 4—+20 mA	-10—+10 V DC/ -20—+20 mA/ 4—+20 mA	-10—+10 V DC/ -20—+20 mA/ 4—+20 mA
Resolution	voltage current	2.5 mV, 1.25 mV, 4 μ A (12 bits)	5 mV (11 bit + sign) 20 μ A (10 bit + sign)	0.32 mV (15 bit + sign) 2.5 μ A (13 bit + sign)
Fullscale overall accuracy	\pm 1 %	\pm 1 %	\pm 0.3–1 %	\pm 0.3–0.5 %**
Power supply	5 V DC 24 V DC	20 mA (from base unit) 50 mA (from base unit)	30 mA (from base unit) 55 mA	110 / 100 mA (from base unit) 90 mA/80 mA
50 mA (from base unit) 80 mA				
Related I/O points	8	8	8	8
Dimensions (WxHxD)	mm 43x90x87	55x90x87	20.2x90x89	75x105x75
Order information	Art. no. 102869	65585	169508/210090	129195

Note: The FX2N-8AD can be configured to accept standard analog inputs as well as selected temperature inputs such as K, T or J type thermocouples.

* for FX3G/FX3U/FX3UC only **Dependent on the ambient temperature

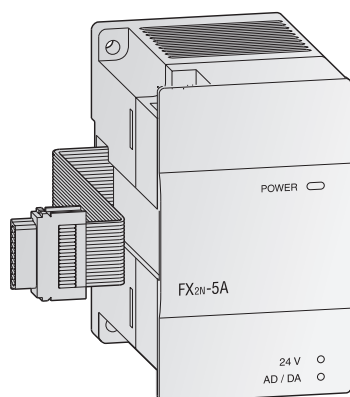

Combined analog I/O modules

The analog input/output modules are available in two different models. They provide the user with 2 or 4 analog inputs and 1 analog output. They serve for conversion of analog process signals into digital values, and vice versa.

As of the FX2N-5A module the analog inputs can be selected between current or voltage input signals.

Specifications	FX0N-3A	FX2N-5A	FX3U-3A-ADP
Analog channels	2	4	2
inputs	—	—	—
outputs	1	1	1
Resolution (input)	voltage current	0—+10 V (8 bit), 0—+5 V (8 bit)	-10—+10 V (15 bit + sign), -100—+100 mV (11 bit + sign)
0—+10 V (2.5 mV/12 bit)			
Resolution (output)	voltage current	0/4—+20 mA (8 bit)	-20—+20 mA (14 bit + sign), 0/4—+20 mA (14 bit)
4—+20 mA (5 μ A/12 bit)			
Power supply	5 V DC 24 V DC	0—+10 V (8 bit), 0—+5 V (8 bit)	-10—+10 V (12 bit)
30 mA (from base unit) 90 mA (from base unit)			
70 mA (from base unit) 90 mA (from base unit)			
20 mA (from base unit) 90 mA			
Related I/O points	8	8	0
Dimensions (WxHxD)	mm 43x90x87	55x90x87	17.6x90x89.5
Order information	Art. no. 41790	153740	221549

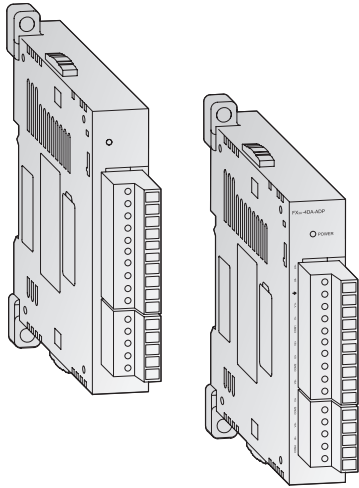

Analog I/O adapters

The FX3U-4AD-ADP adapter module for analog input is a special function adapter to add four analog input points to the FX3G or FX3U/FX3UC PLC system.

The FX3U-4DA-ADP adapter module for analog output is a special function adapter to add four analog output points to the FX3U/FX3UC PLC system.

Specifications	FX3U-4AD-ADP	FX3U-4DA-ADP
Analog channels	4	—
inputs	—	4
outputs	—	4
Analog range	0—+10 V DC, 4—+20 mA	0—+10 V DC, 4—+20 mA
Resolution	2.5 mV/10 μA (12 bit/11 bit)	2.5 mV/4 μA (12 bit)
Overall accuracy	±0.5 %/±1 %	±0.5 %/±1 %
Power supply	5 V DC 24 V DC	15 mA (from base unit) 40 mA 15 mA (from base unit) 150 mA
Related I/O points	0	0
Dimensions (WxHxD)	17.6x90 (106)x89.5	17.6x90 (106)x89.5
Order information	165241	165271

*Dependent on the ambient temperature and signal quality
 Note: when connecting these adapter modules to a FX3U, a communications adapter FX3U-□□□□-BD is required. When connecting an adapter to a FX3G PLC the communications adapter FX3G-CNV-ADP is required.

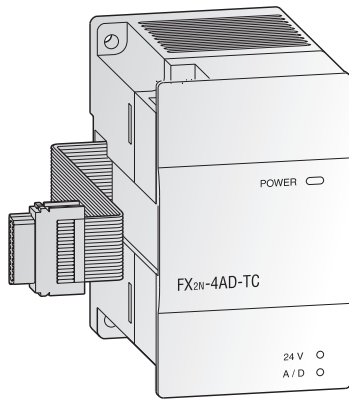

Analog temperature input modules

The analog input module for thermocouples FX2N-4AD-TC is used for processing temperatures. It has 4 independent inputs for detecting signals from thermocouples of types J and K. The type of thermocouple can be chosen independently for each point.

The temperature control module FX2N-2LC is equipped with two temperature input points and two transistor (open collector) output points. It is used to read temperature signals from thermocouples and Pt100 sensors, and performs PID output control.

The analog input module for Pt100 inputs FX2N-4AD-PT permits the connection of four Pt100 sensors to the FX3G, FX3GC, FX3GE, FX3U or FX3UC series controller.

Specifications	FX2N-4AD-TC	FX2N-4AD-PT	FX2N-2LC
Analog inputs	4 (J or K type)	4 (Pt100 sensors)	2 channels*
Compensated temperature range	-100—+600 (J type)/ -100—+1200 (K type)	-100—+600	Thermocouple and Pt100 sensor
Digital outputs	-1000—+6000 (J type)/ -1000—+12000 (K type)	-1000—6000 (12 bit conversion)	2 transistor output points
Resolution	0.3 (J type)/0.4 (K type)	0.2—0.3 °C	0.1 °C or 1 °C
Power supply	5 V DC 24 V DC	40 mA (from base unit) 60 mA	30 mA (from base unit) 50 mA 70 mA (from base unit) 55 mA
Related I/O points	8	8	8
Dimensions (WxHxD)	mm 55x90x87	55x90x87	55x90x87
Order information	Art. no. 65588	65587	129196

*Temperature input modules with 10 channels on request.

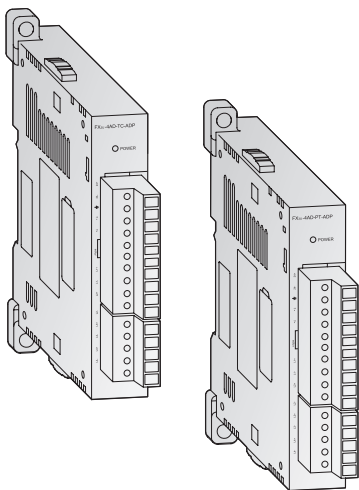

Analog temperature input adapters

The analog input adapter for thermocouples FX3U-4AD-TC-ADP is used for processing temperatures. It has 4 independent inputs for detecting signals from thermocouples of types J and K.

The FX3U-4AD-PT-ADP and FX3U-4AD-PTW-ADP analog input adapters enable the connection of up to four Pt100 thermocouples to the PLC system.

The FX3U-4AD-PNK-ADP analog input adapter enables the connection of up to four Pt1000/Ni1000 thermocouples.

All analog adapters can be used in combination with the base units of the FX3G/FX3U/FX3UC series only.

Specifications	FX3U-4AD-TC-ADP	FX3U-4AD-PNK-ADP	FX3U-4AD-PT-ADP	FX3U-4AD-PTW-ADP
Analog inputs	4 (J or K type)	(Pt1000/Ni1000 sensors, 2/3 wire)	4 (Pt100 sensors)	4 (Pt100 sensors, 3-wire)
Compensated temperature range	-100—+600 (J type)/ -100—+1000 (K type)	-50—+250 (Pt1000)/ -40—+110 (Ni1000)	-50—+250	-100—+600
Digital outputs	-1000—+6000 (J type)/ -1000—+10000 (K type)	-500—+2500 (Pt1000)/ -400—+1100 (Ni1000)	-500—+2500	-1000—+6000
Resolution	0.3 (J type)/0.4 (K type)	0.1	0.1	0.2—0.3
Total accuracy	±0.5 % fullscale	±0.5—1.0 % (fullscale)*	±0.5—1.0 % (fullscale)*	±0.5—1.0 % (fullscale)*
Power supply	5 V DC 24 V DC	15 mA (from base unit) 45 mA	15 mA (from base unit) 50 mA	15 mA (from base unit) 50 mA
Related I/O points	0	0	0	0
Dimensions (WxHxD)	mm 17.6x90 (106)x89.5	17.6x90 (106)x89.5	17.6x90 (106)x89.5	17.6x90 (106)x89.5
Order information	Art. no. 165273	214172	165272	214173

*Dependent on the ambient temperature
 Note: when connecting these adapter modules to a FX3U, a communications adapter FX3U-□□□□-BD is required. When connecting an adapter to a FX3G PLC the communications adapter FX3G-CNV-ADP is required.

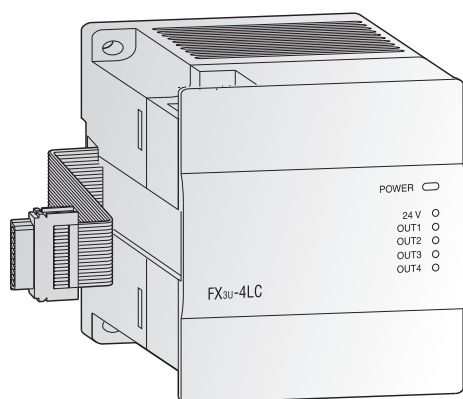

Temperature control module

The temperature control module FX3U-4LC is equipped with four temperature input points and four transistor (open collector) output points. It is used to read temperature signals from thermocouples and Pt100 sensors, and performs PID output control.

The proportional band, the integral time and the derivative time can be easily set by auto tuning.

The channels are isolated against each other. Self-diagnosis functions are provided, and the disconnection of heaters can be detected by current detection (CT).

Specifications	FX3U-4LC
Analog inputs	4 (Thermocouple and Pt100 sensors)
Compensated temperature range	°C -200—+2300
Digital outputs	4 NPN transistor open collector output points
Resolution	°C 0.1 or 1
Total accuracy	±0.3–0.7 % (fullscale, dependent on the ambient temperature)
Power supply	5 V DC 160 mA (from base unit)
	24 V DC 50 mA
Related I/O points	8
Dimensions (WxHxD)	mm 90x90x86
Order information	Art. no. 232806

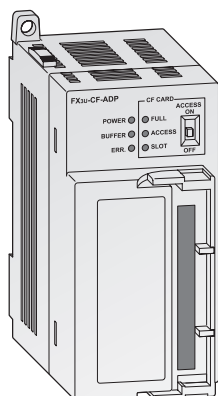

Data logger module

The FX3U-CF-ADP is a general purpose data logging adapter. The difference to other available logging units is that the PLC main unit controls the data logging based on user requirements, e.g. periodical or even based. For tracing a timestamp is automatically added to all data storages, that eases alarm and other time critical

logging. Another usage is the storage of bigger recipe data. A CompactFlash memory card up to 2 GB can be used. Six applied instructions allow all kinds of data writing, manipulation or reading, making this adapter the optimum solution towards customer requirements.

Specifications	FX3U-CF-ADP
Data access method	Controlled by the main unit, no polling from the logging unit possible.
Connectable units	A maximum of one FX3U-CF-ADP can be connected per PLC.
Time stamp function	The real time clock data of the base unit is used.
Recommended storage media	CompactFlash memory card (GT05-MEM-256MC, -512MC, -1GC, -2GC)
Max. file size	512 MB
File format	CSV
Max. numbers of files	63 (Plus one FIFO file.)
FIFO function	One pattern (The file name gets automatically generated.)
Power supply	24 V DC 130 mA
Related I/O points	0
Dimensions (WxHxD)	mm 45x90x89.5
Order information	Art. no. 230104

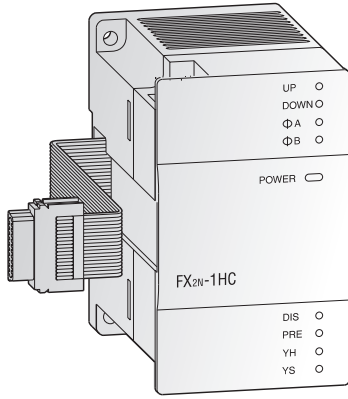

High speed counter and pulse train modules

These high speed modules provide additional counting and pulse train output features to the FX3U/FX3UC PLC. The high speed counters allow 1- or 2-phase pulses with counting speeds up to a maximum of

50 kHz for the FX2N-1HC and 200 kHz for the FX3U modules. The FX3U-2HSY-ADP pulse train output module can provide pulse streams up to 200 kHz for use in basic positioning applications.

Specifications	FX2N-1HC	FX2NC-1HC*	FX3U-4HSX-ADP**	FX3U-2HSY-ADP**	FX3U-2HC
Signal level	5, 12, 24 V DC/7 mA	5 V DC	Differential line driver	5, 12, 24 V DC	
Counter	inputs	2 (1 phase) or 1 (2 phase)	4	—	2
	outputs	—	—	2	2
Max. frequency	inputs kHz	50	100/200	—	100/200
	outputs kHz	—	—	200	—
Counting range (Up/down & ring counter)	16 bit	0–65535	—	—	0–65535
	32 bit	–2147483648–+2147483647	—	—	–2147483648–+2147483647
Output	5–24 V DC; 0.5 A	—	less than 25 mA	5–24 V DC; 0.5 A	
Power supply	5 V DC	90 mA (from base unit)	30 mA (from base unit)	245 mA (from base unit)	
	24 V DC	—	30 mA (from base unit)	60 mA (from base unit)	
Related I/O points	8	0	0	8	
Dimensions (WxHxD)	mm 55x90x87	20.2x90x89	17.6x90 (106)x89.5	17.6x90 (106)x89.5	55x90x87
Order information	Art. no. 65584	217916	165274	165275	232805

*for FX3UC only ** for FX3U only

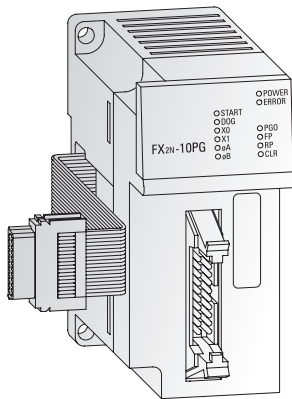

Positioning modules

The positioning modules FX3U-1PG and FX2N-10PG are extremely efficient single-axis positioning modules for controlling either step drives or servo drives (by external regulator) with a pulse chain. They are very suitable for achieving accurate positioning in combination with the FX3U-/FX3UC series PLCs.

The configuration and allocation of the position data are carried out directly via the PLC program.

A very wide range of manual and automatic functions are available to the user.

Specifications	FX3U-1PG	FX2N-10PG
Accessible axes	1	1
Output frequency pulse/s	10–200 000	1–1 000 000
Signal level for digital inputs	24 V DC/40 mA	5 V DC/100 mA; 24 V DC/70 mA
Power supply	5 V DC	150 mA (from base unit)
	24 V DC	120 mA (from base unit)
Related I/O points	8	8
Dimensions (WxHxD)	mm 43x90x87	43x90x87
Order information	Art. no. 259298	140113

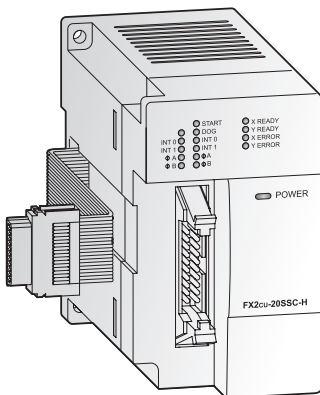

SSCNETIII module FX3U-20SSC-H

The SSCNET module FX3U-20SSC-H can be used in combination with a FX3U/FX3UC programmable controller to achieve a cost effective solution for high precision, high speed positioning. The plug- and-play fiber optic SSCNET cabling reduces setup time and increases control distance for positioning operations in a wide range of applications.

Servo parameters and positioning information for the FX3U-20SSC-H are easily set up with an FX3U or FX3UC base unit and a personal computer. For parameter setting, monitoring and testing the easy programming software FX Configurator-FP is available.

Specifications	FX3U-20SSC-H
Accessible axes	2 (independent or interpolation) via SSCNETIII (servo bus)
Output frequency	1 Hz to 50 MHz
Communications speed	50 Mbps
Starting time ms	1.6 (+1.7 SSCNET cycle time)
Max. to PLC connectable modules	Up to 8 can be connected to the FX3U PLC
Power supply	5 V DC
	24 V DC
Related I/O points	8
Dimensions (WxHxD)	mm 55x90x87
Order information	Art. no. 206189

Note: The FX3U-20SSC-H can only be used in combination with a FX3U/FX3UC series base unit. For applicable servo amplifiers and motors please refer to the MR-J3 servo section of this catalogue.

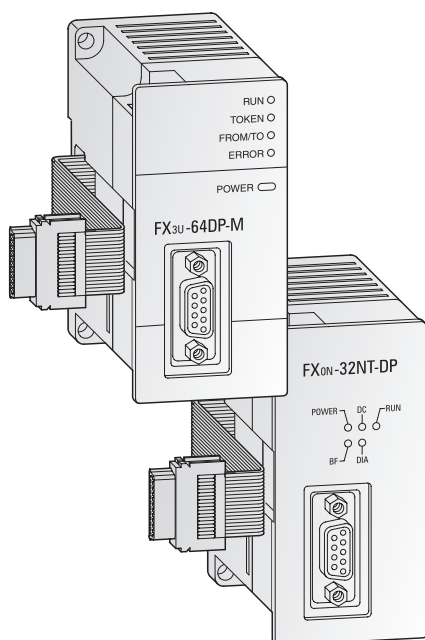

Master and slave modules for Profibus DP

The Mitsubishi Electric Profibus modules provide an FX family CPU with an intelligent Profibus DP link for the implementation of decentralised control tasks.

The FX3U-64DP-M is a Profibus DP master module that allows the integration of a MELSEC FX3U or FX3UC PLC system as a class 1 master in a Profibus DP network.

The FX3U Profibus DP master supplies comprehensive data and alarm processing to the Profibus DP V1 standard. It is easily set up with the GX Configurator-DP software.

The FX0N-32NT-DP and FX3U-32DP are Profibus DP slave modules that make it possible to integrate a FX3G, FX3GC, FX3GE, FX3U or FX3UC in an existing Profibus DP network.*

It links the system to the master PLC in the Profibus DP network for efficient and trouble-free data exchange.

Specifications	FX3U-64DP-M	FX3U-32DP	FX0N-32NT-DP
Module type	Master	Slave	Slave
Transmission type	Bus network		
Transmission data	32 byte/slave (normal service mode) 244 byte/slave (extended service mode)		
Interface	Profibus DP (with 9 pole D-Sub connector)		
Max. number of master per configuration	1	—	—
Repeaters	3	—	—
Max. number of slaves	64	—	—
Communications speed	Profibus standard		
Communications distance	m Max. 1,200 (depends on communication speed)		
Communication cable	Profibus cable with 9-pin D-Sub connector		
Power supply	5 V DC 24 V DC	— 145 mA (from base unit)	Max. 170 mA (from base unit) 60 mA
Related I/O points	8	8	8
Dimensions (WxHxD)	mm 43x90x87	43x90x87	43x90x87
Order information	Art. no. 166085	194214	62125

*Note: the FX3U-64DP-M can be used in combination with a FX3U/FX3UC base unit only.
The FX3U-32DP can be used in combination with FX3G/FX3U/FX3UC base unit only.

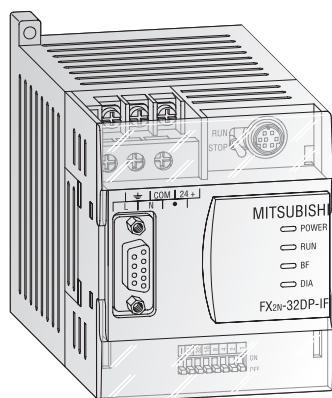

Remote I/O station FX2N-32DP-IF

The remote I/O station FX2N-32DP-IF forms an extremely compact communication unit and provides a connection of I/O modules with up to 256 I/O points and/or up to 8 special function modules of the FX2N series as an alternative (analog I/Os, network, communications and positioning modules).

It features an entire electrical isolation of the Profibus DP connector and of the sensor/actuator circuits.

The FX2N-32DP-IF includes a 240 V power supply unit and a 24 V service voltage terminal, e.g. for analog modules. The FX2N-32DP-IF-D is supplied with 24 V DC. Profibus data such as the baud rate or I/O data can be monitored directly with the programming software or on the hand-held programming unit FX-30P. This facilitates an easy error diagnosis directly on the remote I/O station.

Specifications	FX2N-32DP-IF	FX2N-32DP-IF-D
Power supply	100–240 V AC(+10 %/-15 %) 50/60 Hz	24 V DC(+20 %/-30 %)
Power consumption	30 VA	14 W
Internal current consumption	5 V DC/max. 220 mA (from base unit), 24 V DC/500 mA	5 V DC/max. 220 mA (from base unit)
Interface (connectors)	9-pin D-Sub for Profibus DP, 8-pin Mini-DIN for PC or programming unit FX-30P	
Communication speed	1200 m kbps	9.6/19.2/45.45/93.75
	1000 m kbps	187.5
	400 m kbps	500
	200 m kbps	1500
	100 m kbps	3000/6000/12000
Communication distance	m Max. 1200 (depends on communication speed)	
Communication cable	Profibus cable with 9-pin D-Sub connector	
Max. number of controllable I/O points	256	
Related I/O points	0	
Dimensions (WxHxD)	mm 75x98x87	
Order information	Art. no. 145401	142763
Accessory	Hand-held programming unit FX-30P; art.-no.: 221540	

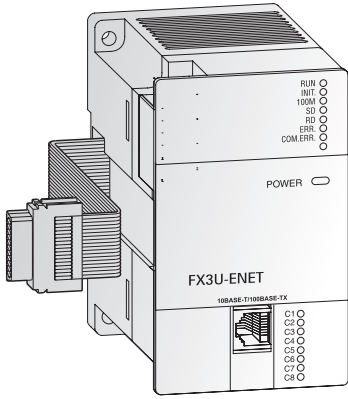

Network module for Ethernet

The FX3U-ENET communications module provides the FX3G or FX3U/FX3UC PLC with a direct connection on to an Ethernet network.

With the Ethernet module installed an FX3G, FX3GC, FX3GE, FX3U or a FX3UC PLC can exchange data quickly and easily with process visualization systems in addition

to supporting full program UP/DOWN load as well as comprehensive monitoring support.

The FX3U-ENET also support Peer to Peer connection and MC Protocol. Up to 8 independent connections are available. It is easily set-up with the FX Configurator-EN software.

Specifications	FX3U-ENET/FX3U-ENET-P502
Protocol	TCP/IP, UDP
Communication mode	Full-duplex/half-duplex
No. of simultaneous open connections	8
Fixed buffer communication	1023 word x 8
Communication with mail server	SMTP, POP3
Interface	IEEE802.3u (100BaseTX), IEEE802.3 (10BaseT)
Connector	RJ45
Max. transfer rate	100 Mbps, 10 Mbps
Max. segment length	m 100
Cable	CAT5 STP or 3 STP
Power supply	24 V DC/240 mA (from base unit)
Related I/O points	8
Dimensions (WxHxD)	mm 55x90x87
Order information	Art. no. 166086/225142

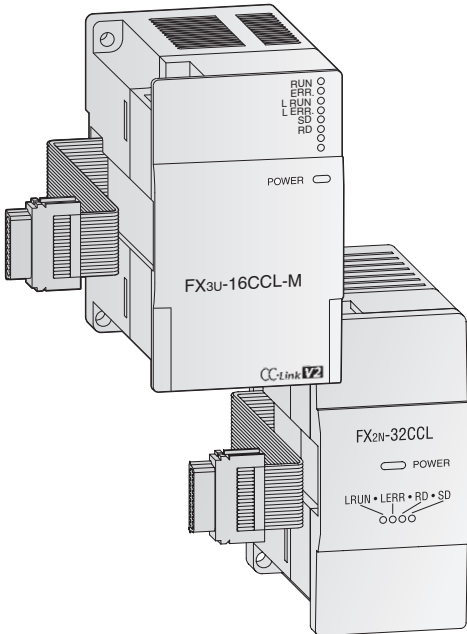

CC-Link master and slave modules

The CC-Link network enables the controlling and monitoring of decentralized I/O modules at the machine.

The CC-Link master module FX3U-16CCL-M is a special extension block which assigns an FX3G, FX3GC, FX3GE, FX3U or FX3UC series PLC as the master station of the CC-Link system.

The setting of all modules within the network is handled directly via the master module.

Up to 16 remote stations and remote device stations can be connected to the master station as decentralized I/O stations. These remote stations can be up to 8 remote device stations or 8 intelligent device stations. 1 master module can be connected to one FX3G, FX3GC, FX3GE, FX3U or FX3UC base unit.

The maximum communications distance is 1200 m without repeater.

The communication modules FX2N-32CCL and FX3U-64CCL enables the user to connect the FX PLC as a slave on an existing CC-Link network.

The buffer memory of the FX2N-32CCL is read and written by FROM/TO instructions.

The slave modules can be used in combination with a FX3G, FX3GC, FX3GE, FX3U and FX3UC PLC.

The connection of the modules is to the extension bus on the right-hand-side of the controller.

Specifications	FX3U-16CCL-M	FX2N-32CCL	FX3U-64CCL*
Module type	Master station	Remote station	Intelligent station
Link points per station	I/O points 32 register 8	32 8	64 16
Max. number of I/O points	FX3G: 32 x number of stations ≤128 FX3U/FX3UC: 32 x number of stations ≤256**	—	—
Number of connectable modules	Max. 16	—	1–4
Power supply	5 V DC — 24 V DC 240 mA	Max. 130 mA (from base unit) 50 mA	— 220 mA
Related I/O points	8	8	8
Dimensions (WxHxD)	mm 55x90x87	43x90x87	55x90x87
Order information	Art. no. 248224	102961	217915

Note: Refer to the Network section of this catalog for I/O blocks and power supply units.

* for FX3G/FX3U/FX3UC only **Total number of I/O points of the base unit and extension units and inside the CC-Link network ≤384.

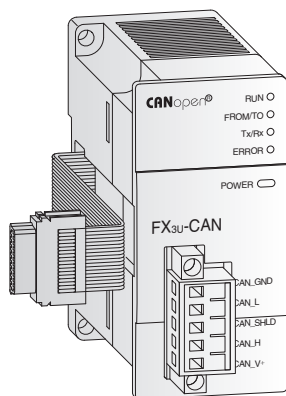

Network module for CANopen

The FX3U-CAN communications module makes it possible to connect an FX3G/FX3GC/FX3GE or FX3U/FX3UC PLC to an existing CANopen network.

In addition to real-time capabilities and high-speed data transfer at rates of up to 1 Mbps the CANopen module also has high transfer reliability and simple network configuration.

Up to 320 data words can be sent and received as process data objects (PDOs). The CANopen profiles CiA 405 V2.0 and CiA 417 V2.0 are supported.

Communication with the module's memory buffer is performed with simple FROM/TO instructions.

Specifications	FX3U-CAN
Module type	CANopen master
CAN standard	ISO 11898/1993
CANopen standard by CiA	DS-301 version 3.0
Additional CANopen features	Based on CiA 301 V4.1, CiA 302, CiA 305 V2.2, CiA 405 V2.0, CiA 417 V2.0 network variables based on DS-405 V1.0
Max. nbr. of modules that can be connected to the network	30 without repeater; 127 with repeater
Station numbers	1-127
Supported baud rate	kBaud 10, 20, 50, 125, 250, 500, 800, 1000
Power supply	5 V DC
	24 V DC
Related I/O points	8
Dimensions (WxHxD)	mm 43x90x95
Order information	Art. no. 252845

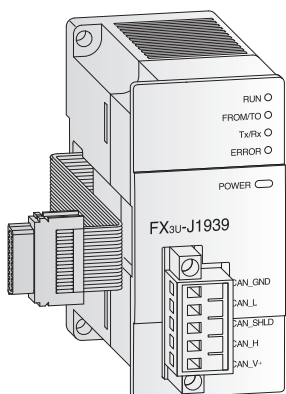

Network module for J1939

The FX3U-J1939 communication module allows the connection of FX3G/FX3GC*/FX3U/FX3UC* Series PLCs to a J1939 network. J1939 is a CAN based protocol used for communication with motors, generators and compressors.

In a J1939 network are no master or slave stations. All nodes may receive each others' messages. Standard messages contain up to 8 bytes of data, extended messages

contain up to 250 bytes of data. Up to 75 standard messages and 4 extension messages can be sent and received.

The FX3U-J1939 is compatible with the NMEA2000 standard used for ship automation and with CAN Layer 2 communication. In this mode, a FX3U-J1939 can send and receive up to 42 messages on a CAN network.

Specifications	FX3U-J1939
Communication standard version	J1939, NMEA2000® compatible node
Network node size	J1939: 2-30 NMEA2000®: 2-50
Communication method	Cyclic, acyclic or request driven (user configurable)
CAN layer-2 communication	Send and receive
Max. cable length	m 5000
Baud rates	kbit/s 10, 20, 50, 100, 125, 250, 500, 800, 1000
Power supply	24 V DC/110 mA (from base unit)
Weight	kg 0.2
Dimensions (WxHxD)	mm 43x90x95
Order information	Art. no. 254276

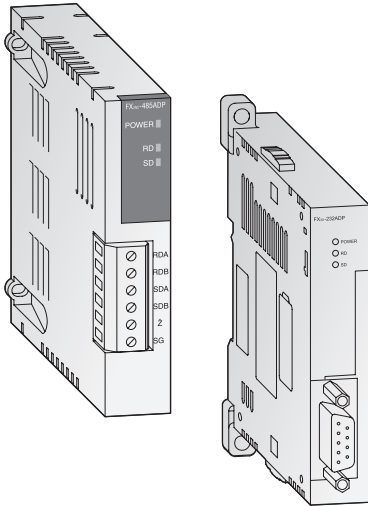

Active data modules (RS485 and RS232)

The addition of active data interface modules permit active communication between the PLC and surrounding devices. With RS232 communications this can include modems, printers, bar code readers, PCs, PLCs etc. Information can be sent and received and is handled by the PLC program with the RS instruction.

With RS485 communication can be configured as either 1:N multidrop, parallel link or peer to peer operation. FX3U-232ADP-MB and FX3U-485ADP-MB also support Modbus RTU and Modbus ASCII.

Specifications	FX2NC-232ADP ^①	FX3U-232ADP-MB ^②	FX2NC-485ADP ^①	FX3U-485ADP-MB ^②
Interface	RS232C with 9 pin D-Sub compact plug (photocoupler isolation)	RS232 with 9-pin D-Sub connector; Modbus RS232C	RS485	RS485; Modbus RS485
Communication speed* kbps	0.3–19.2	0.3–19.2	0.3–19.2	0.3–19.2
Max. communication distance m	15	15	500	500
Power supply	5 V DC 100 mA (from base unit) 24 V DC	30 mA (from base unit)	max. 150 mA (from base unit)	20 mA (from base unit)
Related I/O points	0	0	0	0
Dimensions (WxHxD) mm	19.1x90x83	17.6x90 (106)x74	19.1x90x78	17.6x90 (106)x74
Order information	Art. no. 149110	206190	149111	206191

① Application for FX1S base unit ② Application for FX3G/FX3GC/FX3GE/FX3U/FX3UC base units
* Speed depends on communication method (Parallel link, N:N Network, No protocol, Dedicated protocol etc.)

Note: When connecting these adapter modules to a FX3U, a communications adapter FX3U-□□□-BD is required. When connecting the FX2NC adapters to a FX1S PLC the communications adapter FX1N-CNV-BD is required. When connecting an FX3U adapter to a FX3G PLC the communications adapter FX3G-CNV-ADP is required.

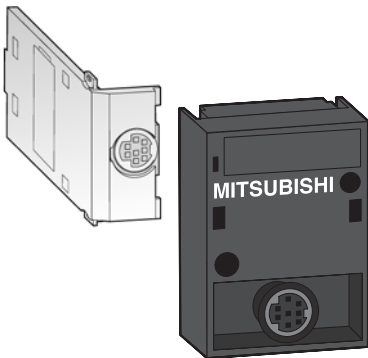

Interface adapters

The FX□□-232-BD interface adapters provide an RS232C interface for serial data communications with the MELSEC FX1S, FX3G or FX3U PLC.

With the help of the interface adapter FX□□-422-BD a RS422 interface can be added to a MELSEC FX1S, FX3G, FX3GE or FX3U PLC.

The interface adapters FX□□-485-BD provide a MELSEC FX1S, FX3G, FX3GE or FX3U PLC with an additional RS485 interface. The adapter, which is simply inserted into the base unit's expansion slot, enables the configuration of RS485 1:n multidrop, parallel link or peer-to-peer networks with FX systems.

Specifications	FX1N-232-BD	FX3G-232-BD	FX3U-232-BD
Applicable for	Base units FX1S	Base units FX3G	Base units FX3U
Interface	RS232C with 9 pole D-Sub connector		
Power supply	5 V DC/20 mA (from base unit)		
Related I/O points	—	—	—
Dimensions (WxHxD) mm	43x38.5x22	35x51x12	19.3x46.1x62.7
Order information	Art. no. 130743	221254	165281

Specifications	FX1N-422-BD	FX3G-422-BD	FX3U-422-BD
Applicable for	Base units FX1S	Base units FX3G	Base units FX3U
Interface	RS422 with 8 pole Mini-DIN connector		
Power supply	5 V DC/60 mA (from base unit)	—	5 V DC/20 mA (from base unit)
Related I/O points	—	—	—
Dimensions (WxHxD) mm	43x38.5x20	35x51x12	19.6x46.1x53.5
Order information	Art. no. 130741	221252	165282

Specifications	FX1N-485-BD	FX3G-485-BD	FX3U-485-BD
Applicable for	Base units FX1S	Base units FX3G	Base units FX3U
Interface	RS485/RS422		
Power supply	5 V DC/60 mA (from base unit)		
Related I/O points	—	—	—
Dimensions (WxHxD) mm	43x38.5x22	35x51x12	19.6x46.1x69
Order information	Art. no. 130742	221253	165283

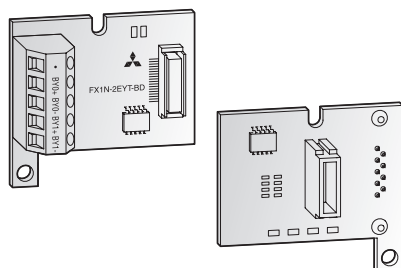

Digital and analog extension adapters FX1S

Two different digital and analog extension adapters are available at a time for direct installation in the base unit controllers of the FX1S series.

Specifications	FX1N-4EX-BD	FX1N-2EYT-BD	FX1N-2AD-BD	FX1N-1DA-BD
Applicable for	Base units FX1S	Base units FX1S	Base units FX1S	Base units FX1S
Function	4 digital inputs	2 transistor outputs	AD converter	DA converter
Dimensions (WxHxD)	mm 43x38.5x22	43x38.5x22	43x38.5x22	43x38.5x22
Order information	Art. no. 139418	139420	139421	139422

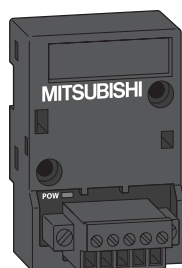

Extension adapters FX3U/FX3G/FX3GE

For the FX3G series PLCs an analog-digital converter with two analog inputs and a digital-analog converter with one analog output is available.

The FX3U-8AV-BD analog setpoint adapter enables the user to set 8 analog setpoint values. All adapters are inserted directly into the extension slot of the base unit.

Specifications	FX3G-2AD-BD	FX3G-1DA-BD	FX3G-8AV-BD	FX3U-8AV-BD
Applicable for	Base units FX3G	Base units FX3G	Base units FX3G	Base units FX3U
Function	A-D converter	D-A converter	Analog setpoint	Analog setpoint
Dimensions (WxHxD)	mm 35x51	35x51	35x51	19.6x46.1x53.5
Order information	Art. no. 221265	221266	221267	237307

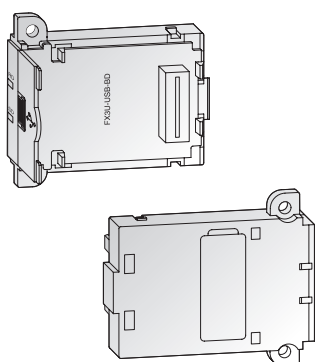

Communication adapter board FX3U-USB-BD

This adapter board is an additional USB 2.0 interface for a FX3U base unit and allows the program transfer from a notebook PC which is not equipped with a serial interface.

Specifications	FX3U-USB-BD
Applicable for	Base units FX3U
Power supply	5 V DC (from base unit)
Weight	kg 0.02
Dimensions (WxHxD)	mm 19.6x46.1x53.5
Order information	Art. no. 165284

Communications adapter

The below listed communications adapters enable the connection of the adapter modules FX□□□□ADP on the left hand side of the FX3G and FX3U base units.

Specifications	FX1N-CNV-BD	FX3G-CNV-ADP	FX3U-CNV-BD
Applicable for	Base unit FX1S	Base units FX3G	Base units FX3U
General specifications	Conforms to base units	Conforms to FX3G base units	Conforms to FX3U base units
Power supply	Not necessary		
Related I/O points	0	0	0
Dimensions (WxHxD)	mm 43x38x14	14.6x74x90	19.6x46.1x53.5
Order information	Art. no. 130745	221268	165285

Power supply modules

To enhance the power supply of a FX3G or FX3U/FX3UC base unit, discrete power supply modules are available.

For detailed information please refer to the power supplies chapter in this catalogue.

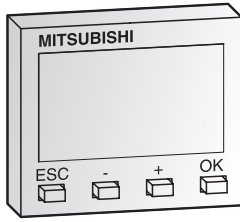

Display modules FX1N-5DM and FX3G-5DM

The display modules FX1N-5DM and FX3G-5DM are inserted directly with space-saving into the controller and

enable monitoring and editing of the data stored in the PLC.

Specifications	FX1N-5DM	FX3G-5DM
Applicable for	Base units FX1S	Base units FX3G series
Display	LCD (with backlight)	LCD (with backlight)
Power supply	5 V DC $\pm 5\%$ (from base unit)	5 V DC $\pm 5\%$ (from base unit)
Current consumption	mA 110	n/a
Dimensions (WxHxD)	mm 40x32x17	49x34x12
Order information	Art. no. 129197	221270

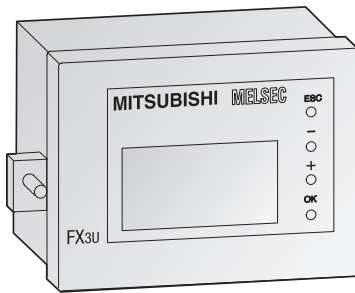

Control and display panel FX3U-7DM, holder FX3U-7DM-HLD

The FX3U-7DM display module can be incorporated in the main unit, or can

be installed in the enclosure using the FX3U-7DM-HLD display module holder.

Specifications	FX3U-7DM	FX3U-7DM-HLD
Applicable for	Base units FX3U	Base units FX3U
Display	16 letters x 4 lines	—
Power supply	5 V DC (from base unit)	—
Current consumption	mA 20	—
Extension cable	—	Included
Dimensions (WxHxD)	mm 48x35x11.5	66.3x41.8x13
Order information	Art. no. 165268	165287

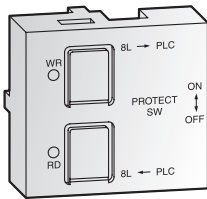

Memory cassettes for FX1S, FX3G and FX3GE

All FX1S, FX3G and FX3GE base units are equipped with a slot for the optional, robust FX memory cassettes. By connection of these memory cassettes, the internal memory of the controller is switched off and only the program specified in the respective memory cassette is run.

The memory cassettes can upload/download programs to and from the FX PLC internal memory with the help of 2 buttons.

The memory cassette FX3G-EEPROM-32L can also be placed on top of the standard BD expansion boards.

Specifications	FX1N-EEPROM-8L	FX3G-EEPROM-32L
Applicable for	Base units FX1S	Base units FX3G
Memory type	EEPROM	EEPROM
Size	2000/8000 steps	32000 steps
Protect switch	Provided	Provided
Data transfer buttons	Provided	Provided
Order information	Art. no. 130746	221269

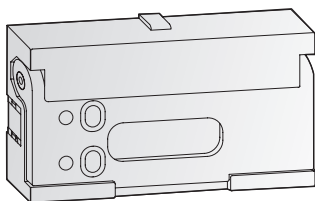

Memory cassettes for FX3U and FX3UC

The memory cassette can be installed in the main unit, and when installed, the memory cassette's internal program is used in place of the internal RAM memory.

The loader functionality in the FX3U-FLROM-64L allows the memory cassette to upload and download programs to and from the internal PLC memory with the help of 2 buttons.

Specifications	FX3U-FLROM-16	FX3U-FLROM-64	FX3U-FLROM-64L	FX3U-FLROM-1M
Applicable for	Base units FX3U	Base units FX3U	Base units FX3U	Base units FX3U
Number of steps	16000	64000	64000	64000 + 1.3 MB for source data
Memory type	Flash memory	Flash memory	Flash memory	Flash memory
Protect switch	Provided	Provided	Provided	Provided
Data transfer buttons	Not provided	Not provided	Provided	—
Dimensions (WxHxD)	mm 37x20x6.1	37x20x6.1	37x20x6.1	37x20x6.1
Order information	Art. no. 165278	165279	165280	245565

The ALPHA 2 series

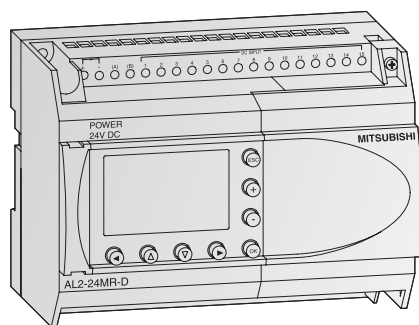

Alpha base units

The Alpha 2 brings the benefits of the Alpha closer to the functionality of a Micro PLC. A program capacity of 200 functions and 38 function blocks including mathematical operations, PWM, 1 KHz high speed counter and SMS text messaging, along with a wide operating temperature (-25 to 55 °C) open up new possibilities in all areas of building and industrial automation. The large back lit screen features display options including bar graphs and scrolling text. Optional extension units can increase the I/O by 4 points of digital I/O.

Features include:

- Expandable with transistor and relay output options
- Analog input/output
- High Speed counters up to 1 kHz
- GSM function for communication with mobile phones
- Multi language support for 8 different languages

Base units with 10–24 I/Os

Specifications		AL2-10MR-A	AL2-10MR-D	AL2-14MR-A	AL2-14MR-D	AL2-24MR-A	AL2-24MR-D
Electrical specifications							
Integrated inputs/outputs		10	10	14	14	24	24
Power supply		100–240 V AC	24 V DC	100–240 V AC	24 V DC	100–240 V AC	24 V DC
Digital inputs		6	6	8	8	15	15
Analog inputs		—	6	—	8	—	8
Channels		—	6	—	8	—	8
Integrated outputs		4	4	6	6	9	9
Max. power consumption	W	4.9	4.0	5.5	7.5	7.0	9.0
Typ. power consumption	all I/Os ON/OFF	3.5/1.85 240 V AC 3.0/1.55 120 V AC	2.5/0.75	4.5/2.0 240 V AC 3.5/1.5 120 V AC	4.0/1.0	5.5/2.5 240 V AC 4.5/2.0 120 V AC	5.0/1.0
Weight	kg	0.2	0.2	0.3	0.3	0.35	0.3
Dimensions (WxHxD)	mm	71.2x90x55	71.2x90x55	124.6x90x52	124.6x90x52	124.6x90x52	124.6x90x52
Order information	Art. no.	215070	215071	215072	215073	215074	215075
Accessories		Power supplies with DIN-rail or wall mounting possibility for powering the 24 V DC modules (refer to the power supply chapter in this catalogue); IP40 mounting frame AL2-FRAME-14/24-IP40, art. no.: 231366; IP54 mounting frame AL2-FRAME-14/24-IP54, art. no.: 231368 for AL2-14/24 IP40 mounting frame AL2-FRAME-10-IP40, art. no.: 231365; IP54 mounting frame AL2-FRAME-10-IP54, art. no.: 231367 for AL2-10					

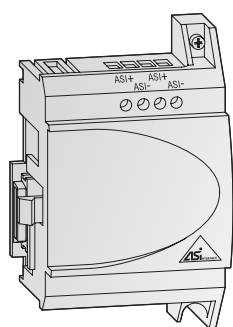

AS interface module AL2-ASI-BD

The Actuator Sensor Interface module AL2-ASI-BD in combination with an ALPHA 2 controller facilitates the data communications via an AS interface system. The AL2-ASI-BD is attached to an ALPHA 2 series module and forms a slave unit. Up to 4 inputs and 4 outputs can be exchanged with the AS Interface master.

The addresses of the slave devices are assigned either automatically via the master in the network or via a programming device (software).

The maximum communication distance is 100 m without a repeater. If 2 repeaters are used, the distance is extended to up to 300 m.

For the AS-Interface a separate power supply is required. The communication signal is superimposed on the power supply of the AS-Interface bus.

Specifications		AL2-ASI-BD
Module type		Slave module
Number of I/O points		4 inputs, 4 outputs
External power supply		30.5 V DC (AS interface power supply)
External current consumption	mA	Max. 40
Communications protocol		AS Interface standard
Weight	kg	0.05
Dimensions (WxHxD)	mm	53.1x90x24.5
Order information	Art. no.	142525

Note: The AL2-ASI-BD cannot be used with the AL2-10MR series.

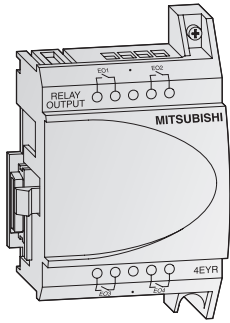

Digital extension modules

There are 4 different extension modules available for the ALPHA 2, which allow the controller to be extended through additional inputs or outputs. The modules are inserted directly into the ALPHA 2 and therefore do not take up any additional space.

The AL2-4EX has the additional feature that 2 inputs may be used as high-speed counters with a counting frequency of 1 kHz. All modules feature photocoupler isolation for all I/Os.

Digital extension modules specifications	AL2-4EX-A2	AL2-4EX	AL2-4EYR	AL2-4EYT
Inputs				
Integrated inputs	4	4	—	—
Input voltage	220–240 V AC	24 V DC (+20 %, -15 %)	—	—
Input current	7.5 mA at 240 V AC (50 Hz), 9.0 mA at 240 V AC (60 Hz)	5.4 mA ± 1 mA at 24 V DC	—	—
Outputs				
Integrated outputs	—	—	4	4
Output type	—	—	Relay	Transistor
Switched voltage (max.)	V	—	250 V AC, 30 V DC	5–24 V DC
Rated current	A	—	2 A per output	1 A per output
Electrical specifications				
Power Supply	AC range (+10 %, -15 %)	220–240 V AC	24 V DC	100–240 V AC
Mechanical specifications				
Dimensions (WxHxD)	mm	53.1x90x24.5	53.1x90x24.5	53.1x90x24.5
Order information				
Art. no.	142522	142521	142523	142524

Note: I1 and I2 of the AL2-4EX can be used as high-speed counter inputs. In each case the response time for the high-speed counter inputs will be 0.5 ms or less. The AL2-4EX-A2, AL2-4EX, AL2-4EYR and AL2-4EYT modules can not be used with the AL2-10MR series.

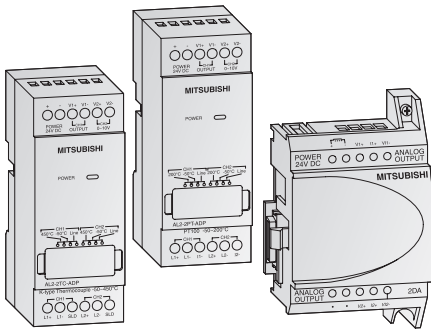

Analog extension modules

The analog extension modules significantly increase the range of applications for the ALPHA 2. With these modules it is possible to output voltage or current signals or to measure temperatures.

Three different analog extension modules are available:

- The AL2-2DA offers two additional analog outputs for the ALPHA 2 and converts a digital input value into a voltage or a current. This module is inserted directly onto the ALPHA 2.

- The AL2-2PT-ADP connects an external Pt100 sensor to convert temperature readings into analog signals (0–10 V).
- The AL2-2TC-ADP connects thermocouple sensors (K type) to convert temperature readings into analog signals (0–10 V).

Analog extension modules specifications	AL2-2DA	AL2-2PT-ADP	AL2-2TC-ADP
Analog inputs			
Integrated inputs	—	2	2
Connectable temperature sensors	—	Pt100 sensor Temp. coefficient 3.850 ppm/°C (IEC 751)	Thermocouple (K type), isolated type (IEC 584-1 1977, IEC 584-2 1982)
Compensated range	—	-50–+200 °C	-50–+450 °C
Analog outputs			
Integrated outputs	2	—	—
Analog output range	voltage	0–10 V DC (5 kΩ–1 MΩ)	—
	current	4–20 mA (max. 500 Ω)	—
Electrical specifications			
Number of channels	2	2	2
Power Supply	24 V DC (-15–+10 %), 70 mA	24 V DC (-15–+20 %), 1 W	24 V DC (-15–+20 %), 1 W
Mechanical specifications			
Dimensions (WxHxD)	mm	53.1x90x24.5	35.5x90x32.5
Order information			
Art. no.	151235	151238	151239

Note: the AL2-2DA module can not be used with the AL2-10MR series

Human Machine Interfaces

HMI control units facilitate communication between operator and machine

HMI control units make systems and their functions transparent, facilitating a process-oriented dialogue between operators and machine. They enable the user to monitor and change their parameters as required. Installation is simple as the HMI units are installed directly at the machine, with no additional modules required for connection to the PLC.

All the information required is at your fingertips, providing maximum transparency for all system processes and with an IP65 rating (IP67 for GOT1000) the HMIs can be used under heavy-duty conditions.

Mitsubishi Electric offers two ranges of Human Machine Interfaces (HMI), the E Series range and the GOT range. These HMIs can be text or graphic and key or touch based. The graphs below are showing the full range of both main ranges of HMIs.

GOT series range

The GOT series is the ultimate in control unit quality and performance. The impressive array of

functions, monitor sizes, and simple touch screen operation give users everything they want and need.

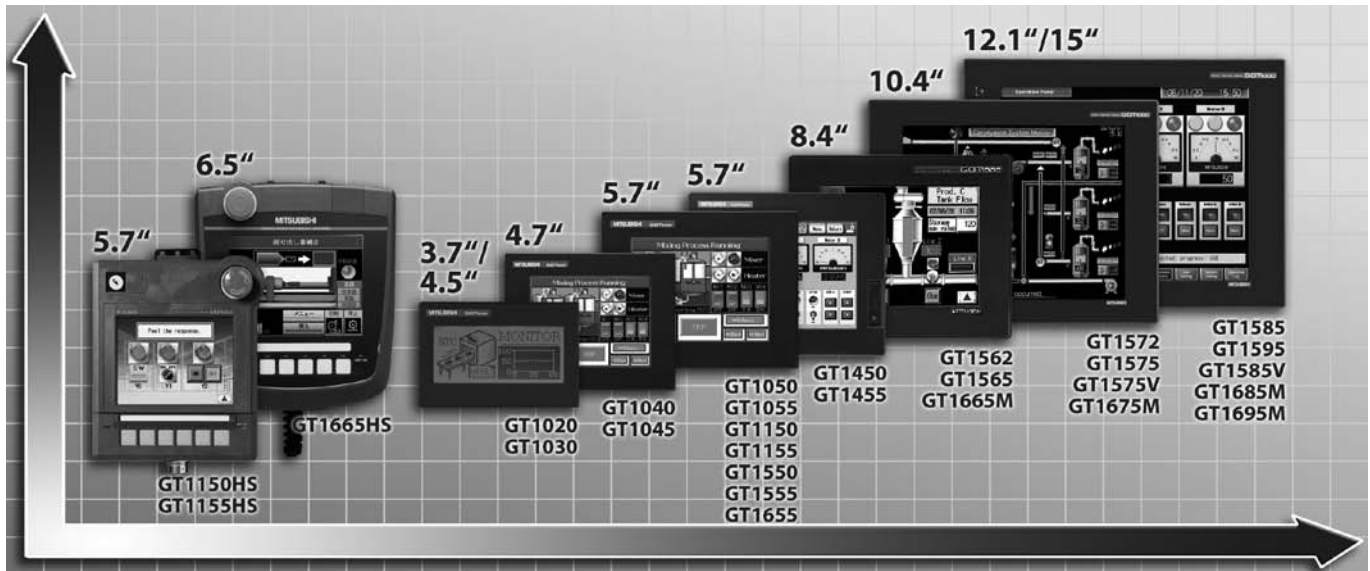

E series range

The E Series is a superb example of successful industrial design. All units are graphic terminals.

Users can select between models with functions keys and high-end touch screen terminals.

Both variants are available with different monitor sizes.

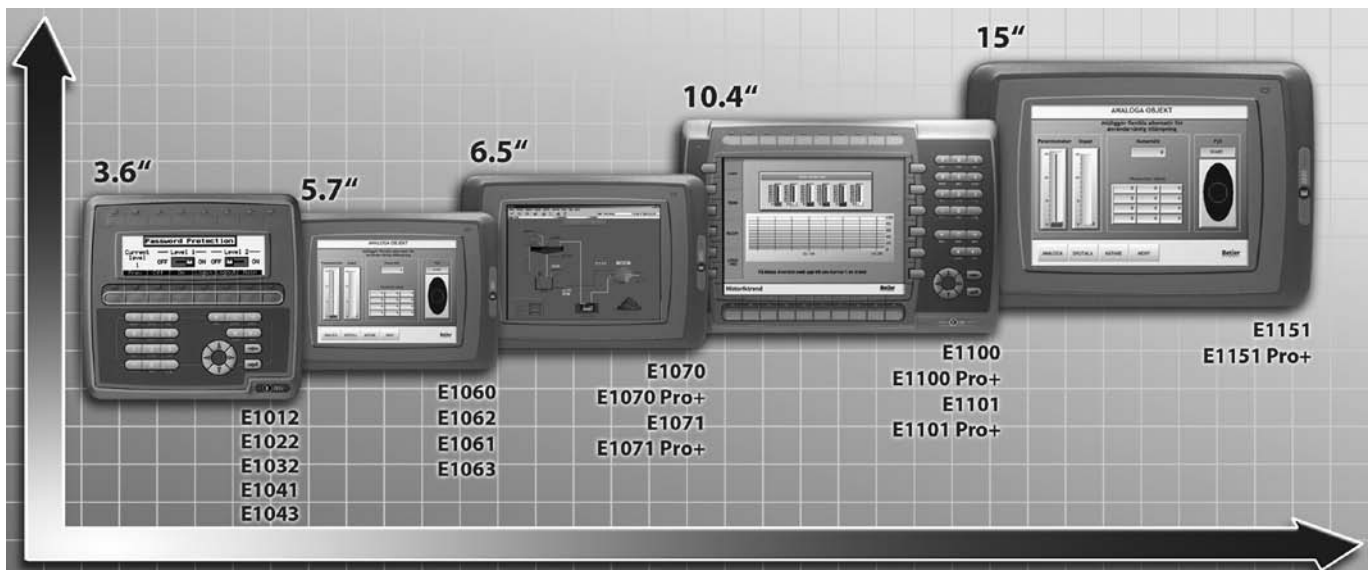

HMI control units for human-machine communication

GOT series

Mitsubishi Electric has once again set new standards in human-machine communication with their new GOT1000 series of touch screen operation terminals. Providing the features customers have been asking for as a top priority in the design of these units – combined with advanced technology and the experience drawn from other series. The result is products that will make work easier for programmers and service staff as well as operators.

The terminals are outstandingly user-friendly. The capabilities of the GOT1000 series really become apparent when they are used in combination with Mitsubishi Electric's MELSEC controllers – whether compact PLCs or modular systems like the advanced iQ Platform – or as human-machine interfaces (HMI) for servo amplifiers or frequency inverter drives.

Some of the highlights of the GOT series are:

- High-resolution screens with 256 or even up to 65,536 colours can also display complex graphics
- Video supported assistance if an error occurs due to multimedia capability
- Fast USB ports, mostly the front of the units, with transparent mode to MELSEC Controllers, servo amplifiers and frequency inverters

- CompactFlash cards or USB memory sticks to transfer and save project data and operation system updates
- Unicode enables display of all international languages
- Online language-switching up to 10 different languages
- Optional interfaces available for Ethernet, Melsecnet/10/H, CC-Link IE as well as additional RS232C and RS422/RS485
- Remote maintenance solution in combination with SoftGOT
- VNC® server support for GT14 and GT16 series

The control units are programmed with the GT Designer3 software package running on a standard PC under MS Windows®.

E series

The most important benefits for the E series include:

- user-friendly text
- control parameters
- data editing
- alarm handling
- recipes
- menu operation
- international characters are supported

The following interfaces are possible on E series HMI units

- RS422/RS232C/RS485
- Profibus DP
- Ethernet TCP/IP

Programming the E Series range of HMIs is done with the E Designer programming software running on a standard PC under MS Windows®.

Drivers for the E series HMI can be easily updated over the Internet. Data communications over longer distances via modems is also possible. This means you can monitor and edit your configuration, programs and data from the comfort of your desk.

Mitsubishi Electric's HMIs can support a large range of international character sets. Like all products in the MELSEC range, the HMI units have CE approval.

All units are applicable for all MELSEC PLC systems and all major third party PLC manufacturers.

GOT series		GT10 (14 models)	GT11 (5 models)	GT12 (4 models)	GT14 (2 models)	GT15 (22 models)	GT16 (20 models)
Display	type	STN	STN	TFT color LCD	TFT, STN	STN, TFT	TFT
	dimensions	3.7"/4.5"/4.7"/5.7"	5.7"	10.4"/8.4"	5.7"	5.7"–15"	5.7"–15"
	text (lines x characters)	User definable	User definable	16-dot standard font: 40 chars. x 30 lines (2-byte) 12-dot standard font: 53 chars. x 40 lines (2-byte)	16-dot standard font: 20 chars. x 15 lines (2-byte) 12-dot standard font: 26 chars. x 20 lines (2-byte)	User definable	User definable
	graphical resolution (pixels)	160x64/288x96/320x240	320x240	640x480	320x240	320x240 to 1024x768	640x480 to 1024x768
Power supply		5 V DC/24 V DC	24 V DC	100 to 240 V AC	24 V DC	24 V DC/220 V AC	24 V DC/220 V AC
Internal memory capacity		512 KB/1.5 MB/3.0 MB	3 MB	9 MB	9 MB	5–9 MB (expandable up to 57 MB)	
External memory card		—	1 (CF, 2 GB max.)	1 (CF, 2 GB max.)	1 (CF)	1 (CF, 2 GB max.)	1 (CF)
Keyboard		Touch-panel	Touch-panel	Touch-panel	Touch-panel	Touch-panel	Touch-panel
Function keys		Touch keys	Touch keys + 6 function keys	Touch keys	Touch keys	Touch keys	Touch keys
Interfaces	serial	2 x RS232, RS422/RS232 (depending on model)	RS232, RS422	RS232, RS422/485	RS232, RS422/485	RS232	RS232
	others	GT104□/GT105□: USB (back side)	USB (front)	USB	USB (Mini-B) (front side) USB (Type-A) (rear side)	USB (front)	USB (front), USB host for memory stick
Network possibilities		Serial	Serial	Ethernet (TCP/IP)	Serial	Ethernet (TCP/IP), CC-Link (IE), RS232, RS422, RS485, A-bus, Q-bus, MELSECNET/10/H, Modbus TCP	
IP Rating (front panel)		IP67	IP67/IP65 (portable models)	IP67	IP67	IP67	IP67

E series		E1012	E1022	E1032	E1041 E1043	E1060 E1062	E1061 E1063	E1070 E1071	E1100 E1101	E1151
Display	type	LCD, monochrome	LCD, monochrome	LCD, monochrome	TFT	TFT	TFT	TFT	TFT	TFT
	dimensions	89.6x17.9 mm	90.2x24.0 mm	135x36 mm	3.5"	5.7"	5.7"	6.5"	10.4"	15"
	text (lines x characters)	User definable								
	graphical resolution (pixels)	160 x32	240x64	240x64	320x240	320x240	320x240	640x480	800x600	1024x768
Power supply		24 V DC (20–30 V)								
Internal memory capacity		512 kB	512 kB	12 MB	12 MB	12 MB	12 MB	12 MB (expandable)	12 MB (expandable)	12 MB (expandable)
External memory card		—	—	—	—	—	—	1 (CF)	1 (CF)	1 (CF)
Keyboard		Membrane	Membrane	Membrane	Touch-panel	Membrane	Touch-panel	Membrane/ Touch-panel	Membrane/ Touch-panel	Touch-panel
Function keys		Yes	Yes	Yes	Touch keys	Yes	Touch keys	Yes/Touch keys	Yes/Touch keys	Touch keys
Interfaces	serial	RS232, RS422/RS232								
	others	—		USB	USB	USB	USB	USB	USB	USB
Network possibilities		Ethernet (TCP/IP) (optional)			Ethernet (TCP/IP), Modbus TCP, MPI (all integrated); Profibus DP (optional)					
IP Rating (front panel)		IP66								

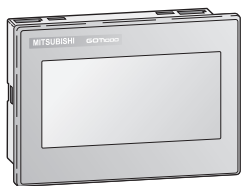
GT1020
GT1030

The micro GOTS GT1020 and GT1030 offer a bright monochrome STN 3.7" or 4.5" display with touch screen functionality and tri-colour background illumination (LBDW and LBLW models, also with white background available) for a broad variety of applications.

Small in dimensions, the versatile micro GOTS offer a number of outstanding powerful features. Different fonts and languages can be used, and when an error occurs the background can be light-up in red as an eye catcher.

They are available with an RS422 (LBL and LBD models) or RS232 (LBL2 and LBD2 models) programming interface.

GT1040
GT1045

The new models GT1040 and GT1050 provide a 2-colour (16 scales of blue/white) STN display, GT1045 and GT1055 a 256 colour STN display. The monitor sizes of GT1040/GT1045 amount to 4.7" and of GT1050/GT1055 amount to 5.7". All displays feature a graphical resolution of 320x240 pixels and are designed as touch screens.

The internal memory, used for projects and system data, is 3 MB. This is twice as big as the memory of a GT1030. With an option module it is possible to save GOT project data. Suitable connection cables for the back side interfaces (e.g. USB, RS422, and RS232) are available, too.

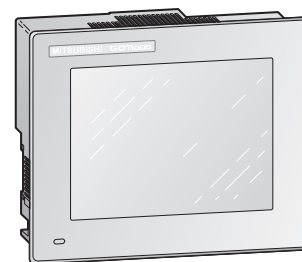
GT1050
GT1055

Apart from many automation components of Mitsubishi Electric also devices of third party manufacturers and PCs can be connected.

The integrated high-speed USB interface (not available for GT1020/GT1030) allows the programming of Mitsubishi Electric PLCs, frequency inverters and servo amplifiers by using transparent mode.

All GOT1000 can be programmed easily via PC with the software package GT Designer3.

All GOT1000 panels can be mounted and used horizontal or vertical, which increases the flexibility in planning and application.

Specifications		GT1020-LBL/-LBD/-LBD2/LBLW/-LBDW/-LBDW2 GT1030-HBD/-HBD2/-HBDW/-HBDW2/-HWD/-HWD2/ GT1030-HWDW/-HWDW2/-HBL/HBLW/-HWL/-HWLW	GT1040-QBBD GT1050-QBBD	GT1045-QSBD GT1055-QSBD	
Display unit	type	STN, monochrome	STN, blue/white, 16 scales	STN, 256 colours	
	dimensions (mm)	86.4x34.5 (3.7")/109.4x36 (4.5")	96x72 (4.7")/115x86 (5.7")	96x72 (4.7")/115x86 (5.7")	
	text (lines x characters)	User definable	User definable	User definable	
	character height (mm)	User definable, Windows fonts	User definable, Windows fonts	User definable, Windows fonts	
	graphical resolution (pixels)	160x64/288x96	320x240	320x240	
Power supply	GT1020: 5 V DC/24 V DC GT1030: 24 V DC 5 V DC/24 V DC		24 V DC	24 V DC	
Internal memory capacity	512 kB/1.5 MB		3.0 MB	3.0 MB	
Memory card slot	—		—	—	
Keyboard type	Touch-panel		Touch-panel	Touch-panel	
Function keys	internal	Touch keys		Touch keys	
	external	—		—	
LED indicators	—		—	—	
Interfaces	serial	RS232, RS422/2 x RS232		RS232, RS422	
	parallel	—		—	
	others	—		USB	
Interface slot for optional cards	—		1, for saving project data	1, for saving project data	
Real-time clock	GT1020: —/GT1030: integrated		Integrated	Integrated	
Network communication possibilities	type	Serial (max. 2 GOTs per FX or Q PLC), Multidrop master (max. 16 GOTs via master unit per FX or Q PLC, Modbus RTU)			
	max. no. of nodes	2		2	
IP Rating (front panel)	IP67		IP67	IP67	
Dimensions (WxHxD)	mm	113x74x27/145x76x29.5	139x112x41/164x135x56	139x112x41/164x135x56	
Weight	kg	0.2/0.3	0.45/0.7	0.45/0.7	
Order information	Art. no.	200738/200491/200492/208670/208668/208669/242110/ 242111/242112/242113/242114/242115/ 242116/242117/242118/242119/242120/242121		221929 218492	221930 218491
		Programming software (refer to page 5), cables and interface adapters (refer to page 101)			

**GT1150
GT1155**

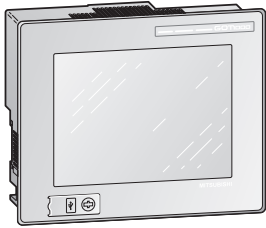

**GT1150HS
GT1155HS**

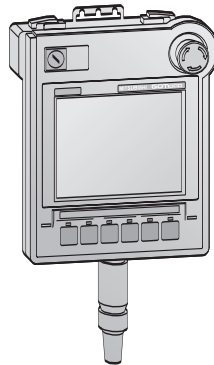

**GT1275
GT1265**

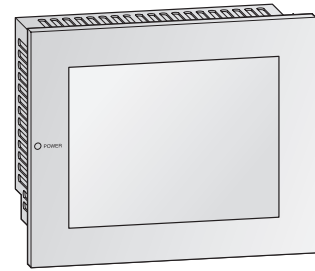

The GT11 series graphic operating terminals GT1150-QLBD and GT1150HS-QLBD (display with 16 grey scales), GT1155-QSBD and GT1155HS-QSBD (256 colours) are the standard models of the versatile GOT1000 series. They offer a wide range of basic functions for stand-alone use.

Beside their outstanding speed and performance they feature a modern design and a first on the market front USB port for project download and PLC maintenance.

The panels can be mounted and used horizontally or vertically.

The GT1150HS-QLBD and GT1155HS-QSBD are handsome portable terminals that boast top level quality for medium sized terminals. They share the same functions as all GT11 series terminals.

Mitsubishi Electric Controllers, inverters and servo amplifiers can be easily programmed via the transparent USB functionality.

All GT11 terminals feature recipes, alarms, multi-language and Unicode support.

Furthermore they offer various graphical object libraries.

The new GT12 models offer flexible configurations and expandability. The built-in interfaces (Ethernet, RS422/485 and RS232) enable connection to up to two kinds of FA equipment simultaneously.

The GT1275 has a 10.4" color touch screen, while the screen size of the GT1265 is 8.4".

Both operator terminals provide many essential functions suited for engineering solutions.

Specifications		GT1150-QLBD/ GT1155-QSBD/GT1155-QTBD	GT1150HS-QLBD/ GT1155HS-QSBD	GT1275-VNBA/GT1275-VNBD/ GT1265-VNBA/GT1265-VNBD
Display unit	type	QL: STN, 16 grey scales QS: STN, 256 colours QT: TFT, 256 colours	QL: STN, 16 grey scales QS: STN, 256 colours	TFT color LCD
	dimensions (mm)	115x86 (5.7")	115x86 (5.7")	10.4"/8.4"
	text (lines x characters)	User definable	User definable	16-dot standard font: 40 chars. x 30 lines (2-byte) 12-dot standard font: 53 chars. x 40 lines (2-byte)
	character height (mm)	User definable, Windows fonts	User definable, Windows fonts	User definable, Windows fonts
	graphical resolution (pixels)	320x240	320x240	640x480
Power supply	24 V DC		24 V DC	VNBA: 100–240 V AC VNBD: 24 V DC
Internal memory capacity	3 MB		3 MB	9 MB
Memory card slot	1 (CompactFlash)		1 (CompactFlash)	1 (CompactFlash, 2 GB max.)
Keyboard type	Touch-panel		Touch-panel	Touch-panel
Function keys	internal	Touch keys		Touch keys
	external	—		—
LED indicators	1 (Power ON)		1 (Power ON)	1 (Power ON)
Interfaces	serial	RS232C, RS422 (2ch)		RS232, RS422/485
	parallel	—		—
	others	USB (front side)		USB
Interface slot for optional cards	—		—	—
Real-time clock	Integrated		Integrated	Integrated
Network communication possibilities	type	Serial (max. 2 GOTs per FX or Q PLC), Multidrop master (max. 16 GOTs via master unit per FX or Q PLC, Modbus RTU)		—
	max. no. of nodes	2		—
IP Rating (front panel)	IP67		IP67	IP67
Dimensions (WxD)	mm	164x135x56	176x220x93	303x214x53/241x190x58
Weight	kg	0.7	1.0	2.3/1.7
Order information	Art. no.	162709/ 162710/215077	170180/170181	229836/237188 229837/237189
		Programming software (refer to page 5), cables and interface adapters (refer to page 101)		

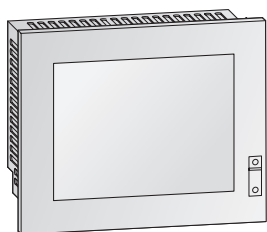
GT1450
GT1455

The GT1450 and GT1455 models provide an exceptionally clear 5.7" display comprising 16 grey scale steps or up to 65,536 colours with a resolution of 320x240 pixels.

Windows fonts are utilized for clear text presentation and a CF card interface for project operation systems and data storage is provided.

The front side USB interface can be used for communication with a PC, OS installation and project data download. Optionally an Ethernet compatible version of each model is available.

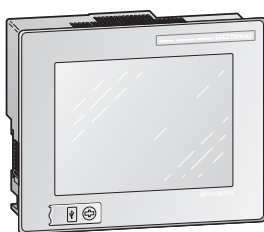
GT1550
GT1555

The GT1550 and GT1555 models provide an exceptionally clear 5.7" display comprising 16 grey scale steps over 4,096 colours up to 65,536 colours and full VGA resolution quality (640x480 pixels).

Windows fonts are utilized for clear text presentation and a CF card interface for project operation systems and data storage is available.

These models open the door to visualization of complex processes with modern functions and full network support.

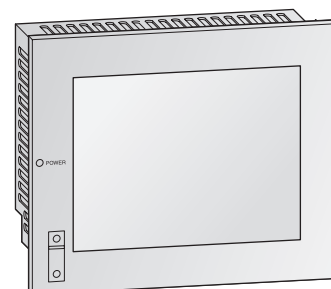
GT1562
GT1565

The proprietary operating system as well as the completely new developed hardware result in an outstanding performance and quality of the GT15 operator terminals. The user can choose between several fast project up- and download options; high-speed serial connection with 115 kBaud, USB or project transfer via CF-card is available.

In addition, the GT15 offer Ethernet project transfer via the optional Ethernet interface GT15-J71E71-100.

Specifications		GT1455-QTBDE/ GT1450-QLBDE	GT1550-QLBD/GT1555-QSBD/ GT1555-QTBD/GT1555-VTBD	GT1562-VNBA/GT1565-VTBA GT1562-VNBD/GT1565-VTBD
Display unit	type	QT: TFT color LCD QL: STN, 16 grey scales	QL: STN monochrome QS: STN 4096 colours QT, VT: TFT, 65536	TFT, 16 colours/65536 colours
	dimensions (mm)	115x86 (5.7")	115x86 (5.7")	171x128 (8.4")
	text (lines x characters)	16-dot standard font: 20 chars. x 15 lines (2-byte) 12-dot standard font: 26 chars. x 20 lines (2-byte)	User definable	User definable
	character height (mm)	User definable, Windows fonts	User definable, Windows fonts	User definable, Windows fonts
	graphical resolution (pixels)	320x240	320x240/VTBD: 640x480	640x480
Power supply	24 V DC	24 V DC	A types: 100–240 V AC D types: 24 V DC	
Internal memory capacity	9 MB	9 MB	VN types: 5 MB (expandable up to 53 MB) VT types: 9 MB (expandable up to 57 MB)	
Memory card slot	1 (CompactFlash)	1 (CompactFlash)	1 (CompactFlash, 256 MB max.)	
Keyboard type	Touch-panel	Touch-panel	Touch-panel	
Function keys	internal	Touch keys	Touch keys (300 per screen)	Touch keys
	external	—	—	—
LED indicators	1 (Power ON)	1 (Power ON)	1	
Interfaces	serial	RS232, RS422/485	RS232	RS232C
	parallel	—	—	—
	others	USB (Mini-B) (front side) USB (Type-A) (rear side)	USB (front side)	USB (on panel front)
Interface slot for optional cards	—	2	1/2	
Real-time clock	Integrated	Integrated	Integrated	
Network communication possibilities	type	Ethernet ^① , RS422/485, RS232	Ethernet, Melsecnet/10/H, CC-Link IE, RS422/RS485, RS232, A-bus, Q-bus	Ethernet, Melsecnet/10/H, CC-Link IE, RS422/RS485, RS232, A-bus, Q-bus
	max. no. of nodes	—	2	2
IP Rating (front panel)	IP67	IP67	IP67	
Dimensions (WxHxD)	mm	164x135x56	167x135x60	241x150x56
Weight	kg	0.7	1.1	1.9
Order information	Art. no.	248881/248880	203472/203471/203470/ 209823	166240/162705 169480/169481
Accessories	Programming software (refer to page 5), cables and interface adapters (refer to page 101)			

^① Only for models GT1455-QTBDE and GT1450-QLBDE (equipped with Ethernet)

GT1572

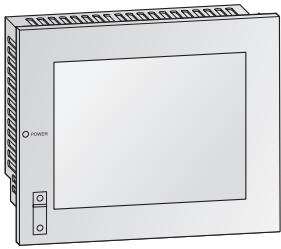

GT1575
GT1575V

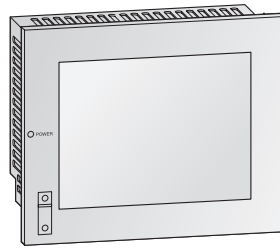

GT1585
GT1595
GT1585V

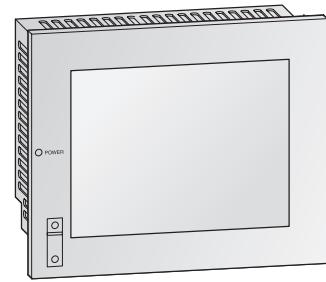

MELSEC PLCs can easily be programmed using the front USB port with integrated Transparent Mode, so updates on PLCs, servo amplifiers, inverters and GOT terminals can be accomplished without opening the cabinet.

The file system of the CF card is PC compatible. Projects and operating system components can be downloaded to the CF card. The GT15 can load the files from the CF card. This is a crucial advantage for manufacturers of serial machines.

In terms of networks, the GT15 are especially powerful with options for MELSECNET/10/H, CC-Link (IE) and Ethernet as well as the four-driver-concept (4 drivers at the same time and the possibility of data exchange via gateway between the drivers as well as third party manufacturers).

By using a MES option card the GT15 are able to communicate direct with Windows databases without needing a Gateway-PC.

The Video models GT1585V-STBD and GT1575V-STBD additionally support video/RGB input to monitor images from PC's, cameras and vision sensors directly on the GOT.

All GT15 operator terminals listed on this page are available as AC type (-A models*) or as DC type (-D models).

* Not for the video models

Specifications		GT1572-VNBA/GT1575-VNBA GT1572-VNBD/GT1575-VNBD	GT1575-VTBA/GT1575-STBA GT1575-VTBD/GT1575-STBD, GT1575V-STBD	GT1585-STBA/GT1595-XTBA GT1585-STBD/GT1595-XTBD, GT1585V-STBD
Display unit	type	TFT, 16 colours/256 colours	TFT, 65536 colours (expandable)	TFT, 256 colours (expandable)
	dimensions (mm)	211x158 (10.4")	211x158 (10.4")	246x185 (12.1")/304x228 (15")
	text (lines x characters)	User definable	User definable	User definable
	character height (mm)	User definable, Windows fonts	User definable, Windows fonts	User definable, Windows fonts
	graphical resolution (pixels)	640x480	640x480/800x600	800x600/1024x768
Power supply	A types	100–240 V AC	100–240 V AC	100–240 V AC
	D types	24 V DC	24 V DC	24 V DC
Internal memory capacity		5 MB (expandable up to 53 MB)	9 MB (expandable up to 57 MB)	9 MB (expandable up to 57 MB)
Memory card slot		1 (CompactFlash 256 MB max.)	1 (CompactFlash 256 MB max.)	1 (CompactFlash 256 MB max.)
Keyboard type		Touch-panel	Touch-panel	Touch-panel
Function keys	internal	Touch keys	Touch keys	Touch keys
	external	—	—	—
LED indicators		1	1	1
Interfaces	serial	RS232C	RS232C	RS232C
	parallel	—	—	—
	others	USB (on panel front)	USB (on panel front)	USB (on panel front)
Interface slot for optional cards		1	2	2
Real-time clock		Integrated	Integrated	Integrated
Network communication possibilities		Ethernet, Melsecnet/10/H, CC-Link IE, RS422/RS485, RS232, A-bus, Q-bus	Ethernet, Melsecnet/10/H, CC-Link IE, RS422/RS485, RS232, A-bus, Q-bus	Ethernet, Melsecnet/10/H, CC-Link IE, RS422/RS485, RS232, A-bus, Q-bus
IP Rating (front panel)		IP67	IP67	IP67
Dimensions (WxHxD)	mm	303x214x56	303x214x56	316x242x56/397x296x61
Weight	kg	2.3	2.3/2.4	2.8/4.9
Order information	Art. no.	166241/166242 169482/169483	162706/162707/169484/169485, video model 203496	162708/169464/169486/203469, video model 203495
	Accessories	Programming software (refer to page 5), cables and interface adapters (refer to page 101)		

GT1655-VTBD
GT1662-VNBA
GT1662-VNBD

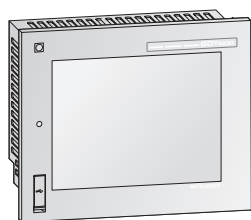

GT1665HS-VTBD

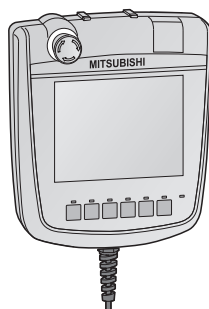

GT1672-VNBA
GT1672-VNBD

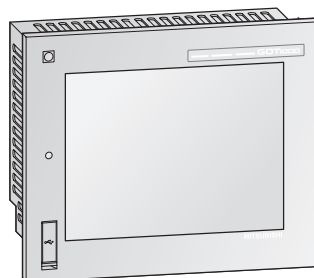

GT1675-VNBA
GT1675-VNBD

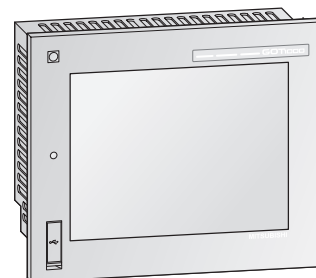

The graphic operating terminals of the GT16 series impress with their functionality and comprehensive connection options. The high-resolution TFT display delivers crisp, sharp images in up to 65,536 colours and can be viewed clearly even from less favourable angles. Screen displays can be created with the intuitive GT Designer3 PC programming package, which makes it easy to program graphical elements like data displays, diagrams and touch key controlled switch

elements and arrange them on the spacious 10.4" screen. The resulting interfaces simplify the operation of even more complex processes.

In addition to generously-dimensioned project and data memory of up to 15 MB (expandable with a CF card), the units come with comprehensive network connections already integrated, including Ethernet, CC-Link, Modbus and MELSECNET. In addition to this you can also use standard serial

interfaces like RS232, RS2422 and RS485. With the exception of the handheld GT1665HS-VTBD control terminal, all the models can also be connected to the bus connector of a MELSEC PLC rack system.

USB ports on the front of the units (except on the handheld GT1665HS-VTBD) make it possible to use standard USB thumb drives for storing projects and data – for example when you are switching the PLC CPU.

You just save the PLC program to the thumb drive via the GT16's USB port and then load it back onto the new PLC when it has been installed.

The GT1665HS-VTBD is a handheld control terminal with the same functions as the stationary units, plus additional function keys and an Emergency OFF button.

Specifications		GT1655-VTBD GT1662-VNBA GT1662-VNBD	GT1665HS-VTBD	GT1672-VNBA GT1672-VNBD	GT1675-VNBA GT1675-VNBD	
Display unit	type	5.7", TFT, 65536 colours 8.4", TFT, 16 colours	6.5", TFT, 65536 colours	10.4", TFT, 16 colours	10.4", TFT, 4096 colours	
	dimensions (mm)	115x86/171x128	211x158	211x158	211x158	
	text (lines x characters)	40 chars. x 30 lines (16 Pkt.) 53 chars. x 40 lines (12 Pkt.)	User definable	40 chars. x 30 lines (16 Pkt.) 53 chars. x 40 lines (12 Pkt.)	40 chars. x 30 lines (16 Pkt.) 53 chars. x 40 lines (12 Pkt.)	
	character height (mm)	User definable, Windows fonts	User definable, Windows fonts	User definable, Windows fonts	User definable, Windows fonts	
	graphical resolution (pixels)	640x480	640x480	640x480	640x480	
Power supply	A types	100–240 V AC	—	100–240 V AC	100–240 V AC	
	D types	24 V DC	24 V DC	24 V DC	24 V DC	
Memory capacity	11–15 MB	15 MB	11 MB	11 MB		
Internal memory capacity	1 (CompactFlash)	1 (CompactFlash)	1 (CompactFlash)	1 (CompactFlash)		
Keyboard type	Touch-panel	Touch-panel	Touch-panel	Touch-panel		
Function keys	internal	Touch keys	Touch keys	Touch keys	Touch keys	
	external	—	—	—	—	
LED indicators	1 (POWER)	1 (POWER)	1 (POWER)	1 (POWER)		
Interfaces	Ethernet (TCP/IP), RS232, RS422/485, USB (front), CF slot	Ethernet (TCP/IP), RS232, RS422/485, USB (Front), CF-Slot	Ethernet (TCP/IP), RS232, RS422/485, USB (Front), CF-Slot	Ethernet (TCP/IP), RS232, RS422/485, A-bus, Q-bus, MELSECNET/10/H		
Interface slot for optional cards	1 CF slot	1 CF slot	1 CF slot	1 CF slot		
Multimedia capability	—	—	—	—		
Real-time clock	Integrated	Integrated	Integrated	Integrated		
Network communication possibilities	Ethernet (TCP/IP), CC-Link (IE), Modbus, RS232, RS422/485, A-bus, Q-bus, MELSECNET/10/H	Ethernet (TCP/IP), Modbus, RS232, RS422/485	Ethernet (TCP/IP), CC-Link (IE), Modbus, RS232, RS422/485, A-bus, Q-bus, MELSECNET/10/H	Ethernet (TCP/IP), CC-Link (IE), Modbus, RS232, RS422/485, A-bus, Q-bus, MELSECNET/10/H		
IP Rating (front panel)	IP67	IP67	IP67	IP67		
Dimensions (WxHxD)	mm	167x135x60/241x190x52	210x230x97	303x214x49	303x214x49	
Weight	kg	1.0/1.8	2.1	2.3	2.3	
Order information	Art. no.	244210 237194 237194	237248	237192 237193	237190 237191	
	Accessories	Programming software (refer to page 5), cables and interface adapters (refer to page 101)				

GT1665M

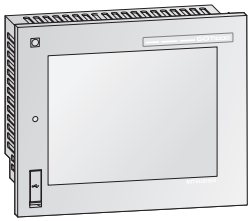

GT1675M

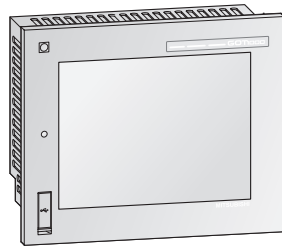

GT1685M

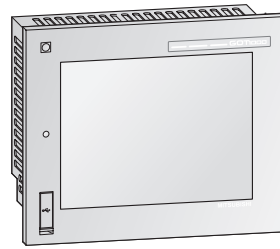

GT1695M

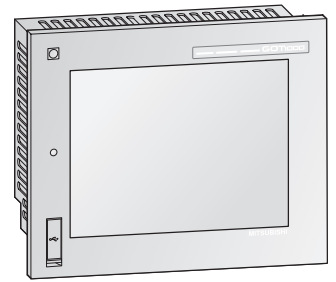

The new all-in-one models of the GT16 series are packed with all the solutions to meet the needs of customers. This leads GT16 terminals to become full components of system control management.

Many of the well-known useful functions are already integrated, e.g. a variety of network connections such as Ethernet and RS422/RS485 beside the generously measured project and data memory of 15 MB (with CF card expandable up to 57 MB max.).

Using separate expansions units it is very easy to upgrade the GT16 with increased memory, special functions or additional interfaces. The high-speed USB ports on the front panel allow the user to save and restore project data and PLC programs via standard USB memory sticks. This is very helpful if the PLC CPU needs to be exchanged. The PLC program can be saved and restored using the USB port of the GT16.

The high-resolution TFT monitor shows pictures, windows, diagrams and touchkeys in highest quality and up to 65536 colours. All screens can be created individually with the GT Designer3 software, installed on a standard PC. Every item can be moved freely on the whole 15" monitor. This makes using easier even for complex applications.

Up to four CCD cameras can be connected, and with an installed multimedia option card it is possible to record and analyze event-driven videos.

Ports for Microphones and speakers are integrated. The build-in Self-diagnosis function recognizes problems and plays an instruction video or shows helpful hints. In perfect interaction with the powerful iQ Platform this function helps to decrease downtimes.

Using an MES option card GT16 operation terminals can communicate directly with Windows databases without the need of a gateway PC.

Specifications		GT1665M-STBA, GT1665M-STBD, GT1665M-VTBA, GT1665M-VTBD	GT1675M-STBA, GT1675M-STBD, GT1675M-VTBA, GT1675M-VTBD	GT1685M-STBA, GT1685M-STBD	GT1695M-XTBA, GT1695M-XTBD
Display unit	type	8.4", TFT, 65536 colours	10.4", TFT, 65536 colours	12.1", TFT, 65536 colours	15", TFT, 65536 colours
	dimensions (mm)	171x128	211x158	249x184.5	304.1x228.1
	text (lines x characters)	User definable	User definable	User definable	User definable
	character height (mm)	User definable, Windows fonts	User definable, Windows fonts	User definable, Windows fonts	User definable, Windows fonts
graphical resolution (pixels)	STB□:	800x600	800x600	800x600 (SVGA)	1024x768 (XGA)
	VTB□:	640x480	640x480		
Power supply	A types	100–240 V AC	100–240 V AC	100–240 V AC	100–240 V AC
	D types	24 V DC	24 V DC	24 V DC	24 V DC
Memory capacity		15 MB	15 MB	15 MB	15 MB (expandable up to 57 MB)
Internal memory capacity		1 (CompactFlash)	1 (CompactFlash)	1 (CompactFlash)	1 (CompactFlash)
Keyboard type		Touch-panel	Touch-panel	Touch-panel	Touch-panel
Function keys	internal	Touch keys	Touch keys	Touch keys	Touch keys
	external	—	—	—	—
LED indicators		1 (POWER)	1 (POWER)	1 (POWER)	1 (POWER)
Interfaces		Ethernet (TCP/IP), RS232, RS422/485, USB (front), CF slot, Human sensor, optional: function cards, Video out			
Interface slot for optional cards		1 CF slot	1 CF slot	1 CF slot	1 CF slot
Multimedia capability		Optional	Optional	Optional	Optional
Real-time clock		Integrated	Integrated	Integrated	Integrated
Network communication possibilities		Ethernet (TCP/IP), CC-Link (IE), Modbus, RS232, RS422/485, A-bus, Q-bus, MELSECNET/10/H			
IP Rating (front panel)		IP67	IP67	IP67	IP67
Dimensions (WxHxD)	mm	241x190x52	303x214x49	316x242x52	397x296x61
Weight	kg	1.7	2.1	2.7	5.0
Order information	Art. no.	221949/221950 221951/221952	221945/221946 221947/221948	221360 221361	221358 221359

Accessories Programming software (refer to page 5), cables and interface adapters (refer to page 101)

E1012
E1022
E1032



E1012, E1022 and E1032 have programmable function keys and a separate keypad. The graphic-capable displays illustrate symbols, alarms, line diagrams and text in arbitrary sizes. Formulas, text and changes in the sequence program can be done directly via the keys.

E1041
E1043

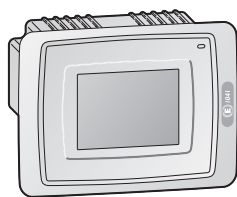

The E1041 and E1043 terminals have a 3.5" TFT touch screen (65,536 colours or 16 grey scales). Recipes, text and editing changes are entered via keys. Password levels protect the system against unauthorised access, while sixteen separate alarm groups keep you informed on all-important developments.

E1060
E1062

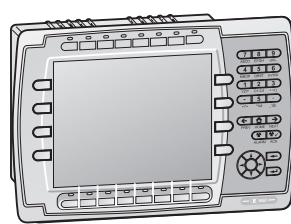

The 5.7" TFT display of the E1060 offers 65,536 colors and 16 function keys for screen-based user-friendly operation. Inputs and changes can be made with the help of the keys. The integrated password protection prevents from unauthorized access. 16 alarm groups keep you informed and up-to-date of all important events. The E1062 is functionally identical to the E1060, but offers 16 shades of gray TFT display instead of the color display.

E1061
E1063

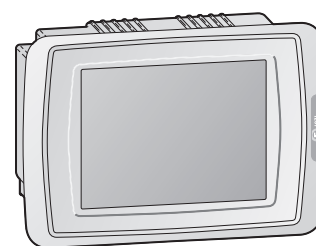

The E1061 and E1063 operator terminals have the same features as E1041 and E1043, but with the 5.7" TFT touch screen (65,536 colors or 16 gray levels), they offer the larger display.

Each unit features two PLC ports, one USB host port to connect mouse, keyboard, printer and USB memory sticks as well as an integrated Ethernet interface.

Profibus DP is available via a separate extension module.

Specifications		E1012/E1022	E1032	E1041/E1043	E1060/E1062	E1061/E1063
Display unit	type	LCD monochrome	LCD monochrome	TFT colour/TFT grey scale	TFT colour/TFT grey scale	TFT colour/TFT grey scale
	dimensions (mm)	89.6x17.9/90.2x24.0	135x36	75x54 (3.5")	120x91 (5.7")	145x110 (5.7")
	text (lines x characters)	User definable	User definable	User definable	User definable	User definable
	character height (mm)	User definable, Windows fonts	User definable, Windows fonts	User definable, Windows fonts	User definable, Windows fonts	User definable, Windows fonts
	graphical resolution (pixels)	160x32/240x64	240x64	320x240	320x240	320x240
Power supply	24 V DC (20–30 V)	24 V DC (20–30 V)	24 V DC (20–30 V)	24 V DC (20–30 V)	24 V DC (20–30 V)	
Internal memory capacity	512 kB	12 MB	12 MB	12 MB	12 MB	
Flash memory	—	32 MB (Intel Strata Flash)	32 MB (Intel Strata Flash)	32 MB (Intel Strata Flash)	32 MB (Intel Strata Flash)	
Keyboard type	Membrane	Membrane	Touch-panel	Membrane	Touch-panel	
Function keys	internal	6	8	Touch keys	16	Touch keys
	external	—	—	—	—	—
LED indicators	6 (integrated in keys)	16 (8 integrated in keys)	1 (Power ON)	16 (8 integrated in keys)	1 (Power ON)	
Interfaces	serial	RS232C, RS422/RS485	RS232C, RS422/RS485	RS232C, RS422/RS485	RS232C, RS422/RS485	RS232C, RS422/RS485
	parallel	—	—	—	—	—
	others	—	USB	USB	USB	USB
Interface slot for optional cards	1	1	1	1	1	
Real-time clock	Integrated	Integrated	Integrated	Integrated	Integrated	
Network communication possibilities	Ethernet (TCP/IP) (optional)	Ethernet (TCP/IP), Modbus TCP, MPI (all integrated); Profibus DP (optional)	Ethernet (TCP/IP), Modbus TCP, MPI (all integrated); Profibus DP (optional)	Ethernet (TCP/IP), Modbus TCP, MPI (all integrated); Profibus DP (optional)	Ethernet (TCP/IP), Modbus TCP, MPI (all integrated); Profibus DP (optional)	
IP Rating (front panel)	IP66	IP66	IP66	IP66	IP66	
Dimensions (WxHxD)	mm	155x114x40/155x155x41	202x187x63	156x119x63	275x168x63	201x152x63
Weight	kg	0.4/0.5	0.9	0.56	1.1	0.87
Order information	Art. no.	202084/202085	169297	169298/169299	216254/216306	216305/216307
Accessories		Programming software E-Designer (refer to page 5), cables and interface adapters (refer to page 101)				

**E1070
E1070 Pro+**

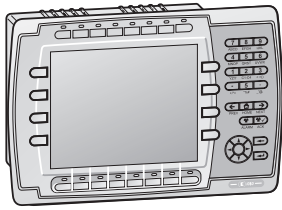

The operator terminal E1070 offers a 6.5" TFT display with 65,536 colours and a resolution of 640x480 pixels. 16 freely programmable function keys facilitate the inputs directly at the terminal.

The 6.5" TFT colour display of the E1071 with 65,536 colours provides a user-friendly touch screen operation. Recipes, text and editing changes are entered via touch keys.

**E1071
E1071 Pro+**

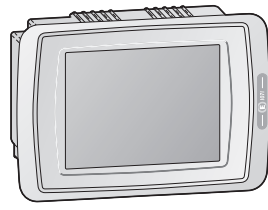

The operator terminal E1100 offers a 10.4" TFT display with 65,536 colours and a resolution of 800x600 pixels. Freely programmable function keys facilitate the inputs directly at the terminal.

The operator terminals E1101 and E1151 provide a user-friendly TFT colour touch screen. The E1101 offers a resolution of 800x600 pixels on a 10.4" screen, the E1151 provides a 15" screen with 1024x768 pixels.

**E1100
E1100 Pro+**

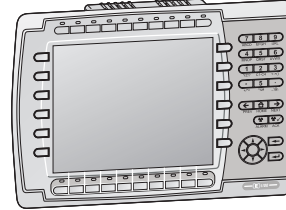

All E1000 operator terminals on this page provide two PLC ports, a USB host port to connect mouse, keyboard, printer and USB memory as well as an integrated Ethernet interface. Profibus DP is available via a separate extension module.

The internal memory of 12 MB can be expanded.

The integrated password protection protect the system against unauthorised access, and sixteen separate alarm groups keep you informed on all-important developments.

**E1101, E1101 Pro+
E1151, E1151 Pro+
DT1151**

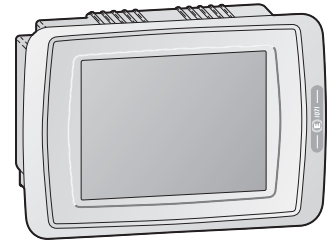

Using an E1000 Pro+ operator terminal gives the user all the functionality of the standard E1000 family but also makes it possible to view external files such as PDF files, HTML pages and PowerPoint presentations directly on the screen of the operator terminal.

The DT1151 is an industrial monitor with a 15" TFT-LCD touch screen, designed to be mounted in a cabinet and connected to an industrial PC. The monitor is optimized for a max. resolution of 1024x768 pixels.

Specifications		E1070/E1070 Pro+	E1071/E1071 Pro+	E1100/E1100 Pro+	E1101/E1101 Pro+, E1151/E1151 Pro+, DT1151
Display unit	type	TFT	TFT	TFT	TFT
	dimensions (mm)	134x100 (6.5")	134x100 (6.5")	211x158 (10.4")	211x158 (10.4") , 304x228 (15")
	text (lines x characters)	User definable	User definable	User definable	User definable
	character height (mm)	User definable, Windows fonts	User definable, Windows fonts	User definable, Windows fonts	User definable, Windows fonts
	graphical resolution (pixels)	640x480	640x480	800x600	800x600 , 1024x768
Power supply	24 V DC (20–30 V)		24 V DC (20–30 V)	24 V DC (20–30 V)	24 V DC (20–30 V)
Internal memory capacity	12 MB (expandable)		12 MB (expandable)	12 MB (expandable)	12 MB (expandable)
Memory card (intern./extern.)	2 (CompactFlash 4–1024 MB)		2 (CompactFlash 4–1024 MB)	2 (CompactFlash 4–1024 MB)	2 (CompactFlash 4–1024 MB)
Keyboard type	Membrane		Touch-panel	Membrane	Touch-panel
Function keys	internal	16 (8 with integrated LEDs)	Touch keys	20 (10 with integrated LEDs)	Touch keys
	external	Max. 64 (optional with MAC-E-Key16)	Max. 64 (optional with MAC-E-Key16)	Max. 64 (optional with MAC-E-Key16)	Max. 64 (optional with MAC-E-Key16)
LED indicators	18		1 (Power ON)	20	1 (Power ON)
Interfaces	serial	RS232C, RS422, RS485		RS232C, RS422, RS485	RS232C, RS422, 485
	parallel	—		—	—
	others	USB		USB	USB
Interface slot for optional cards	1		1	1	1
Real-time clock	Integrated		Integrated	Integrated	Integrated
Network communication possibilities	Ethernet TCP/IP, Modbus TCP, MPI (all integrated); Profibus DP (optional)		Ethernet TCP/IP, Modbus TCP, MPI (all integrated); Profibus DP (optional)	Ethernet TCP/IP, Modbus TCP, MPI (all integrated); Profibus DP (optional)	Ethernet TCP/IP, Modbus TCP, MPI (all integrated); Profibus DP (optional)
IP Rating (front panel)	IP65		IP65	IP65	IP65
Dimensions (WxHxD)	mm	285x177x62	219x154x61	382x252x64	302x228x64 , 398x304x60
Weight	kg	1.3	1.1	2.3	2.0/3.7
Order information	Art. no.	156096/203301	156097/203302	156098/203303	156099/203324 156100/203325/DT1151: 203326
Accessories	Programming software E-Designer (refer to page 5), cables and interface adapters (refer to page 101)				

Interface adapters and cables

The HMI communications and interface adapters support connection directly to a PLC or directly to a network.

All GT15 modules can be used for the GT16 terminals, too, except the Ethernet module GT15-J71E71-100.

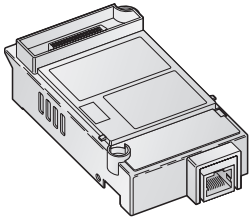

Adapter type (use)	Interface name	Application	Order number
MELSEC A-bus interface	GT15-75ABUSSL	GT15/GT16 (1 channel), slim model	166243
	GT15-ABUS	GT15/GT16 (1 channel), standard model	169467
	GT15-75ABUS2SL	GT15/GT16 (2 channels), slim model	166304
	GT-15ABUS2	GT15/GT16 (2 channels), standard model	169468
MELSEC Q-bus interface	GT15-75QBUSL	GT15/GT16 (1 channel), slim model	166305
	GT15-QBUS	GT15/GT16 (1 channel), standard model	169465
	GT15-75QBUS2SL	GT15/GT16 (2 channels), slim model	166306
Ethernet RJ45	GT15-QBUS2	GT15/GT16 (2 channels), standard model	169466
	GT15-J71E71-100	GT15	166309
Serial interface	GT15-RS2-9P	GT15/GT16 (serial interface RS232, 9-pin D-Sub)	169469
	GT15-RS2T4-9P	GT15/GT16 (converter RS232 -> RS422; 9-pin D-Sub) *	166307
	GT15-RS4-9S	GT15/GT16 (serial interface RS422/485, 9-pin D-Sub)	169470
	GT15-RS4-TS	GT15/GT16 (serial interface RS422/485, screw terminals)	169471
	GT15-RS2T4-25P	GT15/GT16 (converter RS232 -> RS422; 25-pin D-Sub)	166308
	GT01-RS4-M	RS485 Multi-drop master unit, 16 GOT's to one FX/Q PLC	225497
CC-Link interface	GT15-J61BT13	GT15/GT16	203494
	GT15-J71GP23-SX	GT15/GT16, CCLink IE interface, 1 GBaud, optical ring	218576
	GT15-J71GF13-T2	GT15/GT16, CCLink IE Field interface	247574
MELSECNET/10	GT15-J71LP23-25	GOT Melsecnet/H/10 for GT15/GT16 HMIs, optical ring(SI)	229842
	GT15-J71BR13	GOT Melsecnet/H/10 for GT15/GT16 HMIs, coaxial bus	229843
USB	GT15-PRN	GT15/GT16 (for USB connection to pictbridge compatible printers)	170169
MES option card (for direct database connection)	GT15-MESB48M	GT15 option card with 48 MB expansion memory and MES functionality	203473
	GT16M-MESB	GT16 option card with MES functionality	221369

* not supported by GT15, 5.7"

For all GOT and E series operator terminals a wide variety of different cables are available.

All cables and interfaces have to be ordered separately due to the specific application.

All GT15 cables can be used for GT16, too. The following table shows an overview of the available cables.

Operator terminal	Interface	Cable name	Connector	Application	Available length (m)	Order number
E1000	RS232	CAB30	D-Sub female connector 9 pin<-> D-Sub female connector 9 pin	Personal Computer	3	163002
	RS232	CAB34	D-Sub male connector 9 pin<-> MINI-DIN male connector 6 pin	MELSEC System Q	3	163006
	RS422	CAB36	D-Sub male connector 25 pin <-> D-Sub male connector 9 pin	Siemens S7/MPI direct	3	205178
	RS422	CAB17	D-Sub male connector 25 pin <-> MINI-DIN male connector 6 pin	MELSEC System Q	3	140472
	RS422	CAB19	D-Sub male connector 25 pin <-> MINI-DIN male connector 8 pin	MELSEC FX family	3	146861
GT1020 GT1030	RS232	GT01-C30R2-6P	Mini-DIN male connector 6 pin <-> D-Sub male connector 9 pin	Personal Computer	3	163959
	RS422	GT10-C30R4-8P	Open terminals <-> MINI-DIN male connector 8 pin	MELSEC FX family	3	200494
	RS232	GT10-C30R2-6P	Open terminals <-> MINI-DIN male connector 6 pin	MELSEC System Q	3	200498
	RS232	GT10-RS2TUSB-5S	Mini-DIN male connector 6 pin <-> MINI-B USB	PC + GT09-C20USB-5P	3	200500 + 166373
GT10 QVGA GT11 GT14 GT15 GT16	RS232	FX-232-CAB1	D-Sub male connector 9 pin <-> D-Sub male connector 9 pin	Personal Computer	3	124972
	USB	GT09-C20USB-5P	USB <-> USB		2	166373
	RS232	GT01-C30R2-6P	D-Sub male connector 9 pin<-> MINI-DIN male connector 6 pin	MELSEC System Q	3	163959
	RS232	GT01-C30R2-9S	D-Sub male connector 9 pin <-> D-Sub male connector 9 pin	MELSEC FX family	3	163957
	RS422	GT01-C□□□R4-8P	D-Sub female connector 9 pin<-> MINI-DIN female connector 8 pin	MELSEC FX family	1, 3, 10, 20, 30	163948 (3 m)
	RS422	GT01-C□□□R4-25P	D-Sub female connector 9 pin <-> D-Sub female connector 25 pin	MELSEC A/System Q	3, 10, 20, 30	163953 (3 m)
	RS232/RS485	GT14-RS2T4-9P	Signal conversion adapter for D-sub female connector 9 pin <-> 5 pin (fixed type)			248882
	USB	GT14-C10EXUSB-4S	Panel-mounted USB port extension	HMI USB Host	1	248883
	Q(A)nS-bus	GT15-A15C□□B	Special bus connector	MELSEC (Q)AnS series	0.7, 1.2, 3, 5	166358 (3 m)
	A-bus, QnA-bus	GT15-C□□□NB	Special bus connector	GT15/GT16 via AnA-/QnA-bus	0.7, 1.2, 3, 5, 10, 20, 30	166371 (3 m)
	MELSEC System Q-bus	GT15-QC□□□B	Special bus connector	MELSEC System Q	0.6, 1, 3, 5, 10	166348 (3 m)
GT16	RS422/RS485	GT16-C20R4-9S	D-Sub female connector 25 pin <-> D-Sub female connector 9 pin	MELSEC System Q	0.2	221380

For further connection possibilities please refer to HMI Technical cataloge

Frequency Inverters

Mitsubishi Electric's comprehensive range of frequency inverters offers a wealth of benefits for the user, making it easy to choose the perfect solution for every drive application.



With most Mitsubishi Electric Frequency Inverters an overload capacity of 200 % is standard. This means they deliver double the performance of the competing inverters with the same rating.

Mitsubishi Electric inverters also have active current limiting. This provides the perfect response characteristics of the current vector system and gives you the confidence you need

for demanding drive applications. The system instantly identifies overcurrents and limits them automatically with its fast response, allowing the motor to continue operating normally at the current threshold.

Mitsubishi Electric inverters are also able to communicate with industry standard bus systems like Ethernet TCP/IP, Profibus DP, Device-Net, CC-Link, CC-Link IE Field, LonWorks, RS485/Modbus RTU making it possible to integrate frequency inverters as part of a complete automation system.

Mitsubishi Electric inverters are real energy savers achieving maximum drive capacity utilisation with minimum power consumption. Flux optimisation ensures that the connected motor only gets exactly the amount of magnetic flux required for optimum efficiency. This is particularly important at low speeds as motors are normally using a voltage/frequency control system.

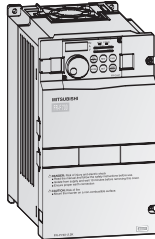
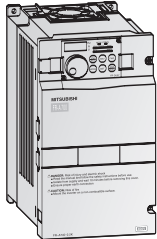
Feature	FR-D700 SC	FR-E700 SC	FR-F700	FR-A700
				
Rated motor output range	0.1–7.5 kW	0.1–15 kW	0.75–630 kW	0.4–630 kW
Frequency range	0.2–400 Hz	0.2–400 Hz	0.5–400 Hz	0.2–400 Hz
Power supply	Single-phase, 200–240 V (-15%/+10 %) Three-phase, 380–480 V (-15%/+10 %)	Single-phase, 200–240 V (-15%/+10 %) Three-phase, 380–480 V (-15%/+10 %)	Three-phase, 380–500 V (-15%/+10 %)	Three-phase, 380–500 V (-15%/+10 %)
Protection	IP20	IP20	FR-F700: IP00/IP20 FR-F746: IP54	FR-A740: IP00/IP20 FR-A741: IP00
Special functions	<ul style="list-style-type: none"> ● V/f control ● Sensorless vector control ● Brake transistor ● Safe Torque Off (STO) according EN 61800-5-2 ● Energy saving control (Optimum excitation control) ● Maintenance timer ● dancer Control 	<ul style="list-style-type: none"> ● V/f control ● Sensorless vector control ● Brake transistor ● Safe Torque Off (STO) according EN 61800-5-2 ● Torque limit ● Ext. brake control ● Flying start ● Remote I/O ● Maintenance timer 	<ul style="list-style-type: none"> ● Energy saving control ● Simple magnetic flux vector control ● V/f control ● Traverse function ● Switch motor to direct mains operation ● Special Function for the Water and HVAC application ● Regeneration avoidance function ● Flying start ● Life time diagnostics ● Integrated PLC function ● Integrated BACNet ● Integrated EMC filter 	<ul style="list-style-type: none"> ● Torque control ● Positon control ● Real Sensorless Vector Control ● Closed loop vector control ● Continuous energy recovery capability (FR-A741) ● Regeneration avoidance function ● Integrated PLC function ● Easy gain tuning ● Life time diagnostics ● Integrated EMC filter
Specifications	Refer to page 104	Refer to page 105	Refer to page 106	Refer to page 108

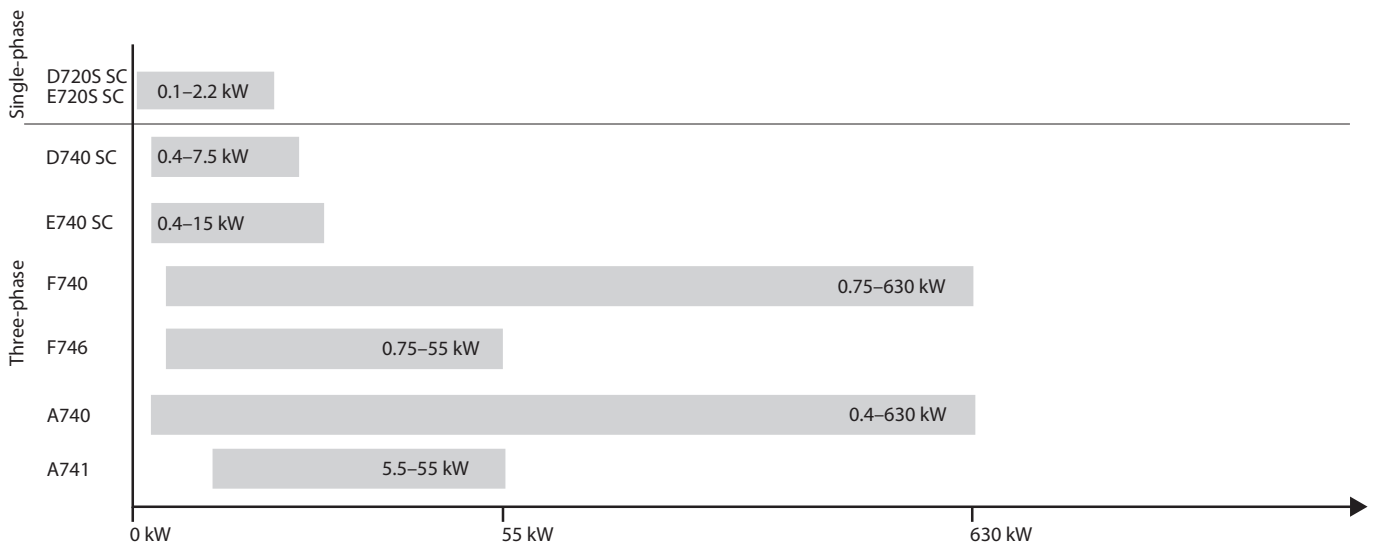

Intelligent technology

Compatible with many new applications

- PID control
The integrated PID control for example supports a flow control for pumps.
- Torque boost
Torque boost selection is possible.

Comprehensive protection functions for safe operation

- Built-in electronic overcurrent protection
- Selection of the protection function for automatic retry after alarm occurrence.

Safety function "Safe Torque Off" (STO) according EN 61800-5-2

The "Safe Torque Off" function (STO) disconnects the power from the motor and prevents an unexpected re-start. Thereupon the motor coasts to a halt. Compared to the traditional technology with contactors, this integrated Safety function reduces the effort in hardware, wiring and maintenance and offers higher performance and lifetime.

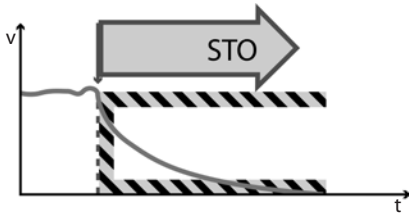

Flexible 5-point V/f curve

The integrated flexible 5-point V/f curve enables you to match the torque curve perfectly to the characteristics of your machine.

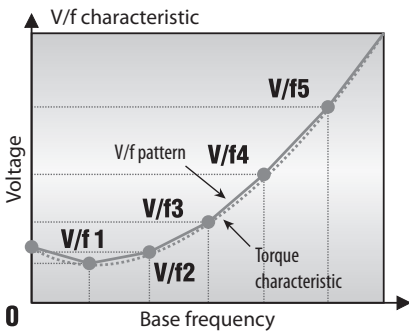

Magnetic flux vector control

The integrated flux vector control of the inverter system makes it possible to achieve high torques, even at low motor speeds.

The sensorless vector control system of the FR-A700 series enables fast, high-precision speed and torque regulation, even when using general-purpose motors without an encoder. When the FR-A7AP is mounted to the FR-A700, full-scale vector control operation can be performed using a motor with encoder.

Fast response/high accuracy speed control (zero speed control, servo lock), torque control, and position control can be performed. Vector control offers excellent control characteristics when compared to V/F control and other control techniques, achieving the control characteristics equal to those of DC machines.

Compatible with numerous I/Os

- Multi-speed operation
(15 different pre-selected speeds are available)
- 0/4 to 20 mA and 0 to 5 V DC/ 0 to 10 V DC control input
- Multi-input terminals: selection of different input functions
- Multi-output terminals: selection of different output functions
- 24 V external power supply output (permissible values: 24 V DC/0.1 A)

Operating functions and other convenient functions

- Frequency jumps (three points) to avoid the machine's resonant frequency
- Fast acceleration/deceleration mode
- Full monitoring capabilities for monitoring actual operating time and much more
- User-selectable alternative configurations with up to three parameter sets
- Zero current detection

Second electronic thermal function

This function is used to rotate two motors of different rated currents individually by a single inverter.

Regeneration avoidance function

The regeneration avoidance function can prevent the inverter from being shut down by regenerative overvoltages when strong regenerative loads cause power to be released into the frequency inverter (for example when braking the motor or with loads that actively drive the motor).

The inverter can automatically increase the output frequency or disable the braking ramp when a programmed threshold value is reached. The response sensitivity, dynamics and working range are all adjustable.

For example, this function can prevent a shutdown with an overvoltage error when the speed of a fan controlled by the inverter is increased by the draft from another fan operating in the same ventilation duct.

The function then temporarily increases the output frequency above the setpoint value.

This function can also be used to brake loads with the DC bus voltage, without using braking modules.

Automatic restart after instantaneous power failures

In pump and fan applications normal operation can be continued automatically after brief power failures. The system simply reactivates the coasting motor and automatically accelerates it back up to its setpoint speed.

The graphic below shows how the frequency inverter can respond to a brief power outage. Instead of coasting down completely and stopping, the motor is automatically "caught" by the frequency inverter and re-accelerated back up to its previous speed.

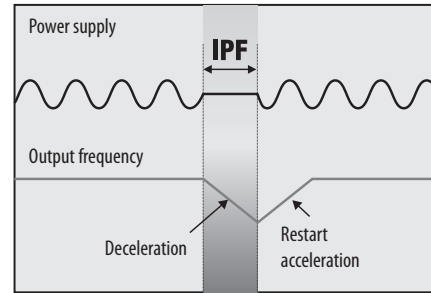

Maintenance timer

The maintenance timer function can be used to monitor the service life of different components.

Power regeneration

The new FR-A741 is equipped with power regeneration function for improving braking performance. Feeding the energy generated by braking back into the power grid generates much less heat than a braking resistor. In addition to cutting power consumption this also reduces installation space requirements by eliminating the need for cooling hardware.

The energy fed back into the grid can also be used for other purposes, reducing operating costs still further. The integrated power regeneration function makes it possible to use smaller and much less expensive drive systems and enables simpler and more compact switchgear cabinet layouts.

FR-D700 SC ultra-compact standard inverters

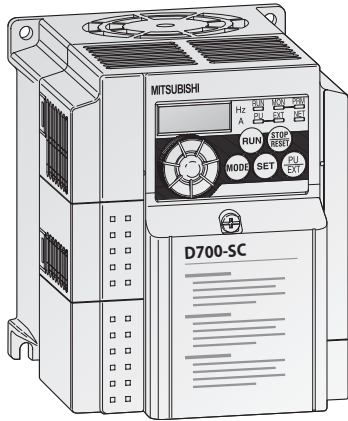

The ultra compact FR-D700 SC series frequency converters excel through their very simple operation whilst still providing many functions.

The spring clamp controller connections version enables simple and fast set-up of the frequency inverter. The D700 has an integrated safety stop and internal safety diodes.

The small dimensions render the FR-D700 SC series frequency inverters ideal for use in restricted spaces. New functions such as intermediate circuit control of the output frequency, the dancer roll control or the traverse function, facilitate universal use in numerous applications such as

- Pumps
- Fans
- Presses
- Conveyor belts
- Industrial washing machines
- Automatic shelf systems

The FR-D720S SC is available in the output power range from 0.1 to 2.2 kW, the FR-D740 SC in the output power range from 0.4 to 7.5 kW.

The frequency inverters FR-D720S SC are for single-phase use 200 to 240 V AC. The frequency inverters FR-D740 SC are designed for three-phase connections 380 to 480 V AC (50/60 Hz).

The output frequency ranges from 0.2 to 400 Hz.

7

Frequency Inverters

Product line		FR-D720S-□SC-EC-E6						FR-D740-□SC-EC-E6									
		008	014	025	042	070	100	012	022	036	050	080	120	160			
Output	Rated motor capacity ①	kW	0.1	0.2	0.4	0.75	1.5	2.2	0.4 (0.55)	0.75 (1.1)	1.5 (2.2)	2.2 (3)	3.7 (4)	5.5 (7.5)	7.5 (11)		
	Rated output capacity ②	kVA	0.3	0.5	1	1.6	2.8	3.8	1.2	2	3	4.6	7.2	9.1	13		
	Rated current ③	A	0.8	1.4	2.5	4.2	7	10	1.2 (1.4)	2.2 (2.6)	3.6 (4.3)	5 (6)	8 (9.6)	12 (14.1)	16 (19.2)		
	Overload capacity ④	150 % of rated motor capacity for 60 s; 200 % for 0.5 s															
Input	Voltage ⑤	3-phase, 0 V up to power supply voltage															
	Power supply voltage	1-phase, 200–240 V AC, -15 %/+10 %						3-phase, 380–480 V AC, -15 %/+10 %									
	Voltage range	170–264 V AC at 50/60 Hz						325–528 V AC at 50/60 Hz									
	Frequency range	50/60 Hz ±5 %						50/60 Hz ±5 %									
Control-specifications	Rated input capacity ⑥	kVA	0.5	0.9	1.5	2.3	4	2.2	1.5	2.5	4.5	5.5	9.5	12	17		
	Control method	V/f control, optimum excitation control or general-purpose magnetic flux vector control															
	Modulation control	Sine evaluated PWM, Soft PWM															
	PWM switching frequency	0.7–14.5 kHz, user adjustable															
	Frequency range	Hz	0.2–400														
	Possible starting torque	≥150 %/1 Hz (for vector control oder slip compensation)															
	Torque boost	Manual torque boost															
	Acceleration/deceleration time	s	0.1–3600														
	Acceleration/deceleration characteristics	Linear or S-pattern acceleration/deceleration mode selectable															
	Braking torque	DC braking	Operating frequency: 0–120 Hz, operating time: 0–10 s, voltage: 0–30 % (externally adjustable)														
	Motor protection	Electronic motor protection relay (rated current user adjustable)															
	Control signals for operation	Frequency setting signal	0–5 V DC, 0–10 V DC, 0/4–20 mA, from operation panel (parameter unit). Frequency setting increment is selectable.														
Input signals		Any of 5 signals can be selected using parameters 178–182 (input terminal function selection): multi-speed selection, remote setting, second function selection, terminal 4 input selection, JOG operation selection, PID control valid terminal, external thermal input, PU-external operation switchover, V/F switchover, output stop, start self-holding selection, traverse function selection, forward rotation, reverse rotation command, inverter reset, PU-NET operation switchover, external-NET operation switchover, command source switchover, inverter operation enable signal, and PU operation external interlock															
Operation functions		Maximum/minimum frequency setting, frequency jump operation, external thermal relay input selection, automatic restart after instantaneous power failure operation, forward/reverse rotation prevention, remote setting, second function, multi-speed operation, regeneration avoidance, slip compensation, operation mode selection, offline auto tuning function, PID control, computer link operation (RS485), optimum excitation control, power failure stop, speed smoothing control, Modbus-RTU															
Output signals		Operating status	Can be selected using parameters 190 and 192 (output terminal function selection): inverter operation, up-to-frequency, overload alarm, output frequency detection, regenerative brake prealarm, electronic thermal relay function prealarm, inverter operation ready, output current detection, zero current detection, PID lower limit, PID upper limit, PID forward/reverse rotation output, fan alarm, heatsink overheat pre-alarm, deceleration at an instantaneous power failure, PID control activated, PID output interruption, during retry, life alarm, current average value monitor, remote output, alarm output, fault output, fault output 3, maintenance timer alarm														
Others		Analog signal	0–10 V DC														
	Cooling		Self cooling			Fan cooling			Self cooling			Fan cooling					
	Protective structure ⑦		IP20														
	Frequency inverter weight	kg	0.5	0.5	0.9	1.1	1.5	2.0	1.3	1.3	1.4	1.5	1.5	3.3	3.3		
Dimensions (WxHxD)	mm	68x128x80.5			68x128 x142.5	68x128 x162.5	108x128 x155	140x150 x145	108x128x129.5			108x128 x135.5	108x128 x155.5	108x128 x165.5	220x150x155		
Order information	Single coated PCB (EC)	Art. no.	247595	247596	247597	247598	247599	247600	247601	247602	247603	247604	247605	247606	247607		
	Double coated PCB (E6)	Art. no.	266097	266098	266099	266100	266100	266102	266103	266104	266135	266136	266137	266137	266139		

Remarks:

- ① The rated motor capacity indicated is the maximum capacity applicable for use of the Mitsubishi Electric 4-pole standard motor. The motor capacity ratings in brackets are for ambient temperatures up to 40 °C.
- ② The specifications of the rated output capacity are related to a motor voltage of 440 V.
- ③ The rated output current in brackets are for ambient temperatures up to 40 °C.
- ④ The % value of the overload capacity rating indicated is the ratio of the overload current to the inverter's rated output current. For repeated duty, allow time for the inverter and motor to return to or below the temperatures under 100 % load.
- ⑤ The maximum output voltage does not exceed the power supply voltage. The maximum output voltage can be changed within the setting range. However, the pulse voltage value of the inverter output side voltage remains unchanged at about $\sqrt{2}$ that of the power supply.
- ⑥ The power supply capacity varies with the value of the power supply side inverter impedance (including those of the input reactor and cables).
- ⑦ FR-DU07: IP40 (except for the PU connector)

FR-E700 SC compact inverters

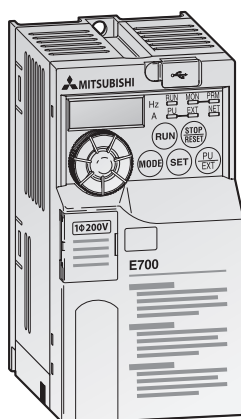

Improved functions and equipment features such as an integrated USB interface, an integrated “digital dial” with display, improved efficiency in the low speed range as well as the possibility of using one of many option cards such as the exchangeable I/O cards, for instance, render the FR-E700 SC a commercial universal genius for many applications, such as

- Textile machines
- Door and gate actuators
- Elevators
- Cranes
- Material handling systems

Improved speed/power limitation guarantees increased machine protection. This reliably prevents damage to the machines.

The FR-E720S SC is available in the output power range from 0.1 to 2.2 kW, the FR-E740 SC in the output power range from 0.4 to 15 kW.

The frequency inverters FR-E720S SC are for single-phase use 200 to 240 V AC. The frequency inverters FR-E740 SC are designed for three-phase connections 380 to 480 V AC (50/60 Hz).

The output frequency ranges from 0.2 to 400 Hz.

Product line	FR-E720S-□SC-EC/-E6						FR-E740-□SC-EC/-E6									
	008	015	030	050	080	110	016	026	040	060	095	120	170	230	300	
Output	Rated motor capacity ①	kW														
	Rated output capacity ②	kVA														
	Rated current ③	A														
	Overload capacity ④	150 % of rated motor capacity for 60 s; 200 % for 3 s														
Input	Voltage ⑤	3-phase, 0 V up to power supply voltage														
	Power supply voltage	1-phase, 200–240 V AC, -15 %/+10 %						3-phase, 380–480 V AC, -15 %/+10 %								
	Voltage range	170–264 V AC at 50/60 Hz						325–528 V AC at 50/60 Hz								
	Frequency range	50/60 Hz ±5 %														
Control-specifications	Rated input capacity ⑥	kVA														
	Control method	V/f control, optimum excitation control, general-purpose magnetic flux vector control or advanced magnetic flux vector control														
	Modulation control	Sine evaluated PWM, Soft PWM														
	PWM switching frequency	0.7–14.5 kHz, user adjustable														
	Frequency range	Hz														
	Possible starting torque	≥200 %/0.5 Hz (advanced magnetic flux vector control (3.7 K or less))														
	Torque boost	Manual torque boost														
	Acceleration/deceleration time	0.01–360 s, 0.1–3600 s (may be set individually for acceleration and deceleration)														
	Acceleration/deceleration characteristics	Linear or S-pattern acceleration/deceleration mode selectable														
	Braking torque DC braking	Operating frequency: 0–120 Hz, operating time: 0–10 s, voltage: 0–30 % (externally adjustable)														
	Motor protection	Electronic motor protection relay (rated current user adjustable)														
	Frequency setting signal	0–5 V DC, 0–10 V DC, 0/4–20 mA, from operation panel (parameter unit)														
	Control signals for operation	Input signals	Any of 7 signals can be selected using parameters 178 to 184 (input terminal function selection): multi-speed selection, remote setting, stop-on contact selection, second function selection, terminal 4 input selection, JOG operation selection, PID control valid terminal, brake opening completion signal, external thermal input, PU-external operation switchover, V/F switchover, output stop, start self-holding selection, forward rotation, reverse rotation command, inverter reset, PU-NET operation switchover, external-NET operation switchover, command source switchover, inverter operation enable signal, PU operation external interlock													
Operation functions		Maximum/minimum frequency setting, frequency jump operation, external thermal relay input selection, automatic restart after instantaneous power failure operation, forward/reverse rotation prevention, remote setting, brake sequence, second function, multi-speed operation, stop-on contact control, drop control, regeneration avoidance, slip compensation, operation mode selection, offline auto tuning function, PID control, computer link operation (RS485)														
Safety stop function		The safety stop signal can be input to terminals S1 and S2 (complying with the safety standards EN ISO 13849-1 category 3, PLd EN62061, IEC61508 SIL2).														
Output signals		Operating status	Can be selected using parameters 190 to 192 (output terminal function selection): inverter operation, up-to-frequency, overload alarm, output frequency detection, regenerative brake prealarm, electronic thermal relay function prealarm, inverter operation ready, output current detection, zero current detection, PID lower limit, PID upper limit, PID forward/reverse rotation output, brake opening request, fan alarm, (from FR-E720S-050SC, from FR-E740-040SC) heatsink overheat pre-alarm, deceleration at an instantaneous power failure, PID control activated, monitor output „safety stop“, monitor output 2 „safety stop“, during retry, life alarm, current average value monitor, remote output, alarm output, fault output, fault output 3, maintenance timer alarm.													
Others	Analog signal	0–10 V DC														
	Cooling	Self cooling		Fan cooling		Self cooling		Fan cooling		Self cooling						
	Protective structure ⑦	IP20														
	Frequency inverter weight	kg														
Order information	Dimensions (WxHxD)	mm														
	Single coated PCB	Art. no.	234795	234796	234797	234798	234799	234800	234801	234802	234803	234804	234805	234806	234807	234808
Double coated PCB (-E6)	Art. no.	240974	240975	240976	240977	240978	240979	240980	240981	240982	240983	240984	240985	240986	240987	240988

Remarks:

- ① The rated motor capacity indicated is the maximum capacity applicable for use of the Mitsubishi Electric 4-pole standard motor.
- ② The specifications of the rated output capacity are related to a motor voltage of 440 V.
- ③ The rated output current in the parentheses applies when low acoustic noise operation is to be performed at an ambient temperature higher than 40 °C with the parameter 72 (PWM frequency selection) value set to 2 kHz or higher.
- ④ The %-value of the overload capacity indicated is the ratio of the overload current to the inverters rated output current.
For repeated duty, allow time for the inverter and motor to return to or below the temperatures under 100 % load.
- ⑤ The maximum output voltage does not exceed the power supply voltage. The maximum output voltage can be changed within the setting range.
However, the pulse voltage value of the inverter output side voltage remains unchanged at about $\sqrt{2}$ that of the power supply.
- ⑥ The power supply capacity varies with the value of the power supply side inverter impedance (including those of the input reactor and cables).
- ⑦ FR-DU07: IP40 (except for the PU connector)

FR-F700 energy saving inverters

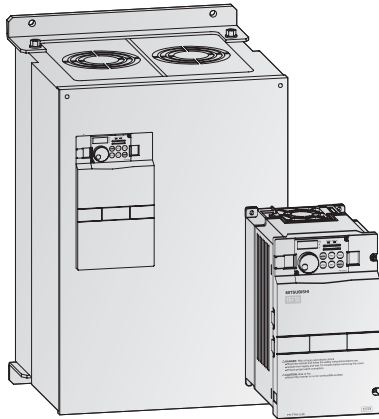

Mitsubishi Electric's FR-F700 series is a range of frequency inverters with truly exceptional power conservation capabilities. These inverters are ideal for pumps, ventilation fans and applications with reduced overload requirements such as:

- Air conditioning systems, e.g. in building management (integrated BACNet)
- Air extraction systems
- Fans and blowers
- Hydraulics systems
- Compressors
- Sewage and drains systems
- Ground water pumps
- Heat pumps
- Drive systems with high idling rates

The integrated PLC functions allow an easy individualisation of the customer's application. The entire machine is controlled by the inverter, where the display functions as a HMI.

The FR-F740 is available in the output power range from 0.75 to 630 kW.

The FR-F746 with its waterproof structure IP54 is available in the output power range from 0.75 to 55 kW.

All the inverters in the series are designed for connection to three-phase 380 to 500 V (50/60 Hz) power supplies.

The output frequency ranges from 0.5 to 400 Hz.

Product line			FR-F740-□-EC/-E1/FR-F746-□-EC																
			00023	00038	00052	00083	00126	00170	00250	00310	00380	00470	00620	00770	00930	01160			
Output	Rated motor capacity ^①	kW	120 % overload capacity (SLD) ^⑤	0.75	1.5	2.2	3.7	5.5	7.5	11	15	18.5	22	30	37	45	55		
		150 % overload capacity (LD)	0.75	1.5	2.2	3.7	5.5	7.5	11	15	18.5	22	30	37	45	55			
	Rated current ^②	A	120 % overload	I_{rated}	2.3	3.8	5.2	8.3	12.6	17	25	31	38	47	62	77	93	116	
			capacity (SLD) ^⑤	$I_{max. 60 s}$	2.5	4.2	5.7	9.1	13.9	18.7	27.5	34.1	41.8	51.7	68.2	84.7	102.3	127.5	
		150 % overload	I_{rated}	2.8	4.6	6.2	10	15.1	20.4	30	37.2	45.6	56.4	74.4	92.4	111.6	139.2		
			capacity (LD)	$I_{max. 60 s}$	2.1	3.5	4.8	7.6	11.5	16	23	29	35	43	57	70	85	106	
	Rated output capacity	kVA	SLD ^⑤	2.5	4.2	5.8	9.1	13.8	19.2	27.6	34.8	42	51.6	68.4	84	102	127.2		
		LD	$I_{max. 3 s}$	3.1	5.2	7.2	11.4	17.2	24	34.5	43.5	52.5	64.5	85.5	105	127.5	159		
	Overload capacity ^②	SLD	120 % of rated motor capacity for 3 s; 110 % for 1 min. (max. ambient temperature 40 °C) – typical for pumps and fans																
		LD	150 % of rated motor capacity for 3 s; 120 % for 1 min. (max. ambient temperature 50 °C) – typical for conveyor belts and centrifuges																
Voltage ^③		3-phase AC, 0 V to power supply voltage																	
Frequency range		0.5–400 Hz																	
Carrier frequency		0.7–14.5 kHz (user adjustable)																	
Input	Power supply voltage		3-phase, 380–500 V AC, -15 %/+10 %																
	Voltage range		323–550 V AC at 50/60 Hz																
	Power supply frequency		50/60 Hz ±5 %																
	Rated input capacity ^④	kVA	SLD ^⑤	2.8	5	6.1	10	13	19	22	31	37	45	57	73	88	110		
LD			2.5	4.5	5.5	9	12	17	20	28	34	41	52	66	80	100			
Others	Cooling		FR-F740	Self cooling			Fan cooling												
	Protective structure ^⑥	FR-F740	IP20 ^⑦												IP00				
		FR-F746	IP54																
	EMC filter		The frequency inverters FR-F740 are fitted with an integrated EMC noise filter for industrial environments (Environment 2) and meet the emission requirements of EN 61800-3, Category C3/C4.																
	Power loss	kW	SLD ^⑤	0.06	0.08	0.1	0.16	0.19	0.24	0.34	0.39	0.49	0.58	0.81	1	1.17	1.51		
		LD		0.05	0.08	0.09	0.14	0.18	0.22	0.31	0.35	0.44	0.52	0.71	0.93	1.03	1.32		
Frequency inverter weight	kg	FR-F740	3.5	3.5	3.5	3.5	3.5	6.5	6.5	7.5	7.5	13	13	23	35	35			
	FR-F746		12.5	12.5	12.5	12.5	12.5	18.5	18.5	21.5	21.5	30	30	30	42	42			
Dimensions (WxHxD)	mm	FR-F740	150x260x140						220x260x170			220x300x190			325x550x195		435x550x250		
	FR-F746		249x395x210						319x395x240			319x445x260			354x560x260		360x590x265		471x660x320
Order information FR-F740 ^⑧	Frequency inverters		156569	156570	156571	156572	156573	156594	156595	156596	156597	156598	156599						
	Double coated PCB (-E1)		158589	158591	158592	158593	158594	158595	158596	158597	158598	158599	158600	158601	158602	158603			
	Input power frame												169827	169828	169829				
	Control card FR-CF70-EC												189878	189878	189878				
Order information FR-F746			Art. no.	163796	163797	163798	163799	163800	163801	163802	163803	163804	163805	163806	163807	163808	163809		

Remark:
Explanation for ① to ⑨ see next page.

Product line		FR-F740-□-EC																	
		01800	02160	02600	03250	03610	04320	04810	05470	06100	06830	07700	08660	09620	10940	12120			
Output	Rated motor capacity ^①	kW	120 % overload capacity (SLD) ^⑤	90	110	132	160	185	220	250	280	315	355	400	450	500	560	630	
			150 % overload capacity (LD)	75	90	110	132	160	185	220	250	280	315	355	400	450	500	560	630
	Rated current ^⑥	A	120 % overload	I_{rated}	180	216	260	325	361	432	481	547	610	683	770	866	962	1094	1212
			capacity (SLD) ^⑤	$I_{max. 60 s}$	198	238	286	357	397	475	529	602	671	751	847	953	1058	1203	1333
		A	150 % overload	I_{rated}	216	259	312	390	433	518	577	656	732	820	924	1039	1154	1313	1454
			capacity (LD)	$I_{max. 60 s}$	144	180	216	260	325	361	432	481	547	610	683	770	866	962	1094
	Rated output capacity	kVA	SLD ^⑤	137	165	198	248	275	329	367	417	465	521	587	660	733	834	924	
			LD	110	137	165	198	248	275	329	367	417	465	521	587	660	733	834	
	Overload capacity ^②		SLD	120 % of rated motor capacity for 3s; 110 % for 1 min. (max. ambient temperature 40 °C) – typical for pumps and fans															
			LD	150 % of rated motor capacity for 3s; 120 % for 1 min. (max. ambient temperature 50 °C) – typical for conveyor belts and centrifuges															
Voltage ^③			3-phase AC, 0 V to power supply voltage																
Frequency range	Hz		0.5–400																
Carrier frequency	kHz		0.7–6 (user adjustable)																
Input	Power supply voltage		3-phase, 380–500 V AC, -15 %/+10 %																
	Voltage range		323–550 V AC at 50/60 Hz																
	Power supply frequency		50/60 Hz ±5 %																
Rated input capacity ^④	kVA	SLD ^⑤	137	165	198	248	275	329	367	417	465	520	587	660	733	834	924		
		LD	110	137	165	198	248	275	329	367	417	465	520	587	660	733	834		
Others	Cooling		Fan cooling																
	Protective structure ^⑦		IP00 ^⑦																
	Power loss	kW	SLD ^⑤	2.7	3.3	3.96	4.8	5.55	6.6	7.5	8.4	9.45	10.65	12	13.5	15	16.8	18.9	
			LD	2.25	2.7	3.3	3.96	4.8	5.55	6.6	7.5	8.4	9.45	10.65	12	13.5	15	16.8	
	Frequency inverter weight	kg	37	50	57	72	72	110	110	220	220	220	260	260	370	370	370	370	
Reactor weight	kg	20	22	26	28	29	30	35	38	42	46	50	57	67	85	95	95		
Dimensions (WxHxD)	mm		435x550x250	465x620x300	465x740x360	498x1010x380	498x1010x380	680x1010x380	680x1010x380	790x1330x440	790x1330x440	995x1580x440	995x1580x440						
Order information ^⑧	Art. no.	Frequency inverters																	
		Input power frame	169830	169831	169832	169833	169834	169835	169836	169837	169838	169839	169840	169841	169842	169843	169844		
		Control card FR-CF70-ECT	189879	189879	189879	189879	189879	189879	189879	189879	189879	189879	189879	189879	189879	189879	189879	189879	

Remarks:

- The applied motor capacity indicated is the maximum capacity applicable for use of the Mitsubishi Electric 4-pole standard motor.
- The overload capacity in % is the ratio of the overload current to the inverter's rated current in the respective operating mode. For repeated duty cycles allow sufficient time for the inverter and the motor to cool below the temperature reached at 100 % load. The waiting periods can be calculated using the r.m.s. current method ($I^2 \times t$), which requires knowledge of the duty.
- The maximum output voltage cannot exceed the power supply voltage. The output voltage can be varied over the entire power supply voltage range.
- The rated input capacity varies depending on the impedance values on the power supply side of the inverter (including the cables and input reactor).
- When the load curve with 120 % overload capacity is selected the maximum permitted ambient temperature is 40 °C.
- When operating with carrier frequencies ³ kHz this value is reduced automatically as soon as the frequency inverter exceeds 85 % of the rated output current.
- When the cable bushing for the optional expansion cards is broken out the unit has an IP00 protection rating.
- FR-DU07: IP40 (except for the PU connector)
- The inverter types FR-F740-01800 and above are all delivered with PCBs with two coats of protective varnish. For types FR-F740-00023 through 01160 varnished PCBs are standard. The double-coated version is available as an option.

Common specifications FR-F740/F746 EC		Description
Control specifications	Voltage/frequency characteristics	Base frequency adjustable from 0 to 400 Hz; selection between constant torque, variable torque or optional flexible 5-point V/f characteristics
	Starting torque	120 % (3 Hz) when set to simple magnetic flux vector control and slip compensation
	Acceleration/deceleration time	0; 0.1–3600 s (can be set individually)
	Acceleration/deceleration characteristics	Linear or S-form course, user selectable
	DC injection brake	Operating frequency (0–120 Hz), operating time (0–10 s) and operating voltage (0–30 %) can be set individually. The DC brake can also be activated via the digital input.
	Motor protection	Electronic motor protection relay (rated current user adjustable)
	Control method	V/f control, optimum excitation control or simple magnetic flux vector control
Control signals for operation	Modulation control	Sine evaluated PWM, Soft PWM
	Input signals	Any of 12 signals can be selected using parameters 178 to 189 (input terminal function selection)
	Output signals	Any of 7 signals can be selected using parameter 190 to 196 (output terminal function selection)
Display	When using the FR-A7AY, FR-A7AR option	In addition to the above operating modes parameters 313 to 319 (function selection for the additional 7 output terminals) can also be used to assign the following four signals: control circuit capacitor life, main circuit capacitor life, cooling fan life, inrush current limit circuit life
	Pulse/analog output	You can also use parameter 54 (assign analog current output) and 158 (assign analog voltage output) to assign the following displays to one or both outputs.
	Parameter unit display (FR-PU07/FR-DU07)	Operating status
	Alarm definition	Output frequency, motor current (steady or peak value), output voltage, alarm indication, frequency setting, motor running speed, converter output voltage (steady or peak value), electronic thermal load factor, input power, output power, road meter, cumulative energization time, actual operation time, motor load factor, watt-hours meter, power saving effect, cumulative saving power, regenerative brake circuit duty (01800 and above), PID set point, PID process value, PID deviation monitor, I/O terminal monitor, optional input terminal monitor (FR-DU07 only), optional output terminal monitor (FR-DU07 only), option fitting state monitor (FR-PU07 only), terminal assignment state (FR-PU07 only)
Interactive guidance	Alarm definition is displayed when the protective function is activated, the output voltage/current/frequency/cumulative energization time right before the protection function was activated and the past 8 alarm definitions are stored.	
		Operation guide/trouble shooting with a help function (FR-PU07 only)

FR-A700 high end inverters

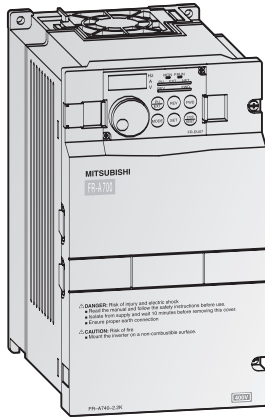

The FR-A700 frequency inverters combine innovative functions and reliable technology with maximum power, economy and flexibility.

The FR-A740 is the appropriate inverter for demanding drive tasks with requirements for high torque and excellent frequency precision. Its extensive functions allow adaption to many applications. The outstanding drive features of the FR-A740 suit various needs, like:

- Conveyor technology
- Chemical machines
- Winding machines

- Printing machines
- Cranes and lifting gear
- High-bay warehousing systems
- Extruders
- Centrifuges
- Machine tools

The FR-A740 is available in the output power range from 0.4 to 630 kW.

All the inverters in the series are designed for connection to three-phase 380 to 500 V (50/60 Hz) power supplies.

The output frequency ranges from 0.2 to 400 Hz.

7

Frequency Inverters

Product line			FR-A740-□-EC-E1																	
			00023	00038	00052	00083	00126	00170	00250	00310	00380	00470	00620	00770	00930	01160				
Output	Rated motor capacity ^①	kW	120 % overload capacity (SLD)	0.75	1.5	2.2	3.7	5.5	7.5	11	15	18.5	22	30	37	45	55			
			150 % overload capacity (LD)	0.75	1.5	2.2	3.7	5.5	7.5	11	15	18.5	22	30	37	45	55			
			200 % overload capacity (ND) ^①	0.4	0.75	1.5	2.2	3.7	5.5	7.5	11	15	18.5	22	30	37	45			
			250 % overload capacity (HD)	0.25	0.4	0.75	1.5	2.2	3.7	5.5	7.5	11	15	18.5	22	30	37			
			120 % overload capacity (SLD)	$I_{nenn}^{③}$	2.3	3.8	5.2	8.3	12.6	17	25	31	38	47	62	77	93	116		
	Rated current ^②	A	I_{max} 60 s	2.5	4.2	5.7	9.1	13.9	18.7	27.5	34.1	41.8	51.7	68.2	84.7	102.3	127.6			
			I_{max} 3 s	2.8	4.6	6.2	10	15.1	20.4	30	37.2	45.6	56.4	74.4	92.4	111.6	139.2			
			150 % overload-capacity (LD)	$I_{nenn}^{③}$	2.1	3.5	4.8	7.6	11.5	16	23	29	35	43	57	70	85	106		
			I_{max} 60 s	2.5	4.2	5.8	9.1	13.8	19.2	27.6	34.8	42	51.6	68.4	84	102	127.2			
			I_{max} 3 s	3.2	5.3	7.2	11.4	17.3	24	34.5	43.5	52.5	64.5	85.5	105	127.5	159			
			200 % overload-capacity (ND)	$I_{nenn}^{③}$	1.5	2.5	4	6	9	12	17	23	31	38	44	57	71	86		
			I_{max} 60 s	2.3	3.8	6	9	13.5	18	25.5	34.5	46.5	57	66	85.5	106.5	129			
			I_{max} 3 s	3	5	8	12	18	24	34	46	62	76	88	114	142	172			
			250 % overload-capacity (HD)	$I_{nenn}^{③}$	0.8	1.5	2.5	4	6	9	12	17	23	31	38	44	57	71		
			I_{max} 60 s	1.6	3	5	8	12	18	24	34	46	62	76	88	114	142			
			I_{max} 3 s	2	3.8	6.3	10	15	22.5	30	42.5	57.5	77.5	95	110	142.5	177.5			
Rated output capacity ^②	kVA	SLD	1.8	2.9	4	6.3	9.6	13	19.1	23.6	29	35.8	47.3	58.7	70.9	88.4				
		LD	1.6	2.7	3.7	5.8	8.8	12.2	17.5	22.1	26.7	32.8	43.4	53.3	64.8	80.8				
		ND	1.1	1.9	3	4.6	6.9	9.1	13	17.5	23.6	29	33.5	43.4	54.1	65.5				
		HD	0.6	1.1	1.9	3	4.6	6.9	9.1	13	17.5	23.6	29	33.5	43.4	54.1				
Overload capacity ^④		SLD	110 % of rated motor capacity for 60 s; 120 % for 3 s (max. ambient temperature 40 °C) – inverse time characteristics																	
		LD	120 % of rated motor capacity for 60 s; 150 % for 3 s (max. ambient temperature 50 °C) – inverse time characteristics																	
		ND	150 % of rated motor capacity for 60 s; 200 % for 3 s (max. ambient temperature 50 °C) – inverse time characteristics																	
		HD	200 % of rated motor capacity for 60 s; 250 % for 3 s (max. ambient temperature 50 °C) – inverse time characteristics																	
Input		Voltage ^⑤	3-phase AC, 0 V to power supply voltage																	
		Frequency range	Hz 0.2–400																	
		Regenerative braking torque	100 % torque/2 % ED																	
		Carrier frequency	kHz 0.7–14.5																	
		Power supply voltage	3-phase, 380–500 V AC, -15 %/+10 %																	
		Voltage range	323–550 V AC at 50/60 Hz																	
		Power supply frequency	50/60 Hz ±5 %																	
		Rated input capacity ^②	kVA	SLD	2.5	4.5	5.5	9	12	17	20	28	34	41	52	66	80	100		
				LD	2.1	4	4.8	8	11.5	16	20	27	32	37	47	60	73	91		
				ND	1.5	2.5	4.5	5.5	9	12	17	20	28	34	41	52	66	80		
HD	0.8			1.5	2.5	4.5	5.5	9	12	17	20	28	34	41	52	66				
Others	Cooling	Protective structure ^⑥	Self cooling Fan cooling																	
		EMC filter	The frequency inverters FR-A740 are fitted with an integrated EMC noise filter for industrial environments (Environment 2) and meet the emission requirements of EN 61800-3, Category C3/C4.																	
	Power loss	kW	SLD	0.06	0.082	0.98	0.15	0.21	0.28	0.39	0.4	0.55	0.69	0.97	1.18	1.36	1.78			
			LD	0.05	0.08	0.09	0.14	0.18	0.22	0.31	0.35	0.44	0.52	0.71	0.93	1.03	1.32			
			ND	0.05	0.065	0.075	0.1	0.15	0.2	0.25	0.29	0.4	0.54	0.65	0.81	1.02	1.3			
			HD	0.043	0.05	0.06	0.075	0.1	0.146	0.18	0.21	0.29	0.4	0.54	0.65	0.74	1.02			
	Frequency inverter weight	kg	3.8	3.8	3.8	3.8	3.8	7.1	7.1	7.5	7.5	13	13	23	35	35				
	Dimensions (WxHxD)	mm	150x260x140						220x260x170			220x300x190			250x400x190			325x550x195		435x550x250
Order information	Art. no.	Frequency inverters	169826	169797	169798	169799	169800	169801	169802	169803	169804	169805	169806							
		Double coated PCB (-E1)	206810	206811	206812	206813	206844	206845	206846	206847	206848	206849	206850	206851	206852	206853				
		Input power frame													169827	169828	169829			
		Control card FR-CA70-EC													169877	169877	169877			

Remark:
Explanation for ① to ⑥ see next page.

Product line			FR-A740-□-EC																
			01800	02160	02600	03250	03610	04320	04810	05470	06100	06830	07700	08660	09620	10940	12120		
Output	Rated motor capacity ^①	kW	120 % overload capacity (SLD)	90	110	132	160	185	220	250	280	315	355	400	450	500	560		
			150 % overload capacity (LD)	75	90	110	132	160	185	220	250	280	315	355	400	450	500	560	
			200 % overload capacity (ND) ^①	55	75	90	110	132	160	185	220	250	280	315	355	400	450	500	
			250 % overload capacity (HD)	45	55	75	90	110	132	160	185	220	250	280	315	355	400	450	
	Rated current ^②	A	120 % overload capacity (SLD)	180	216	260	325	361	432	481	547	610	683	770	866	962	1094	1212	
			150 % overload capacity (LD)	144	180	216	260	325	361	432	481	547	610	683	770	866	962	1094	
			200 % overload capacity (ND)	110	144	180	216	260	325	361	432	481	547	610	683	770	866	962	
			250 % overload capacity (HD)	86	110	144	180	216	260	325	361	432	481	547	610	683	770	866	
			120 % overload capacity (SLD)	198	238	286	358	397	475	529	602	671	751	847	953	1058	1203	1333	
			150 % overload capacity (LD)	173	216	259	312	390	433	518	577	656	732	820	924	1039	1154	1313	1454
			200 % overload capacity (ND)	126	165	204	243	300	339	411	450	522	594	682	790	908	1036	1214	1402
			250 % overload capacity (HD)	99	126	165	204	243	300	339	411	450	522	594	682	790	908	1036	1214
			120 % overload capacity (SLD)	216	259	312	390	433	518	577	656	732	820	924	1039	1154	1313	1454	
			150 % overload capacity (LD)	173	216	259	312	390	433	518	577	656	732	820	924	1039	1154	1313	
			200 % overload capacity (ND)	126	165	204	243	300	339	411	450	522	594	682	790	908	1036	1214	
			250 % overload capacity (HD)	99	126	165	204	243	300	339	411	450	522	594	682	790	908	1036	
	Rated output capacity ^②	kVA	SLD	137	165	198	248	275	329	367	417	465	521	587	660	733	834	924	
			LD	110	137	165	198	248	275	329	367	417	465	521	587	660	733	834	
			ND	84	110	137	165	198	248	275	329	367	417	465	521	587	660	733	
			HD	80	84	110	137	165	198	248	275	329	367	417	465	521	587	660	
	Overload capacity ^④		SLD	110 % of rated motor capacity for 60 s; 120 % for 3 s (max. ambient temperature 40 °C) – inverse time characteristics															
			LD	120 % of rated motor capacity for 60 s; 150 % for 3 s (max. ambient temperature 50 °C) – inverse time characteristics															
			ND	150 % of rated motor capacity for 60 s; 200 % for 3 s (max. ambient temperature 50 °C) – inverse time characteristics															
HD			200 % of rated motor capacity for 60 s; 250 % for 3 s (max. ambient temperature 50 °C) – inverse time characteristics																
Voltage ^⑤		3-phase AC, 0 V to power supply voltage																	
Frequency range		Hz 0.2–400																	
Regenerative braking torque (max. value/permissible duty)		20 % torque/continuous 10 % torque/continuous ^⑥																	
Carrier frequency		kHz 0.7–14.5 0.7–6																	
Input	Power supply voltage		3-phase, 380–500 V AC, -15 %/+10 %																
	Voltage range		323–550 V AC at 50/60 Hz																
	Power supply frequency		50/60 Hz ±5 %																
	Rated input capacity ^⑦	kVA	SLD	137	165	198	247	275	329	366	416	464	520	586	660	733	833	924	
			LD	110	137	165	198	247	275	329	366	416	464	520	586	659	733	833	
ND			100	110	137	165	198	248	275	329	367	417	465	521	587	660	733		
HD			80	84	110	137	165	198	248	275	329	367	417	465	521	587	660		
Cooling		Fan cooling																	
Protective structure ^⑧		IP00 ^⑧																	
Others	Power loss	kW	SLD	2.65	2.9	3.57	3.8	4.2	5.02	5.5	6.4	7.2	8.19	8.6	10.37	11.5	13.2	14.94	
			LD	2	2.4	2.9	3	3.8	4.2	5.1	5.5	6.4	7.2	8	8.6	10.2	11.5	13.2	
			ND	1.54	1.9	2.4	2.5	3	4	4.2	5	5.5	6.5	7	7.3	8.1	9.3	10.5	
			HD	1.14	1.44	1.9	1.97	2.5	2.57	4	4.2	5	5.5	6.5	7	6.91	8.1	9.3	
	Frequency inverter weight		kg 37 50 57 72 72 110 110 175 175 175 260 260 370 370 370																
	Reactor weight		kg 20 22 26 28 29 30 35 38 42 46 50 57 67 85 95																
Dimensions (WxHxD)		mm 435x550x250 465x620x300 465x740x360 498x1010x380 680x1010x380 790x1330x440 995x1580x440																	
Order information	Art. no.	Frequency inverters																	
		Input power frame		169830	169831	169832	169833	169834	169835	169836	169837	169838	169839	169840	169841	169842	169843	169844	
		Control card FR-CA70-ECT		169877	190051	190051	190051	190051	190051	190051	190051	190051	190051	190051	190051	190051	190051	190051	

- Remarks:
- The rated motor capacity indicated is the maximum capacity applicable for use of the Mitsubishi Electric 4-pole standard motor. The 200 % overload capacity (ND) is the factory default setting.
 - The rated output capacity indicated assumes that the output voltage is 440 V.
 - When operating the inverter of 75 K (type 02160) or more with a value larger than 2 kHz set in Pr. 72 PWM frequency selection, the rated output current is max. 85 %.
 - The % value of the overload capacity indicates the ratio of the overload current to the inverter's rated output current. For repeated duty, allow time for the inverter and motor to return to or below the temperatures under 100 % load.
 - The maximum output voltage does not exceed the power supply voltage. The maximum output voltage can be changed within the setting range.
However, the pulse voltage value of the inverter output side voltage remains unchanged at about $\sqrt{2}$ that of the power supply.
 - For the 11 K to 22 K capacities (type 00023 to 00250 and 00310 to 00620), using the dedicated external brake resistor (FR-ABR-H) will achieve the performance of 100 % torque/6 % ED.
 - The rated input capacity varies depending on the impedance values on the power supply side of the inverter (including the cables and input reactor).
 - When the cable bushing for the optional expansion cards is broken out the unit has an IP00 protection rating.
 - FR-DU07: IP40 (except for the PU connector)

FR-A741 high end inverters with integrated power regeneration function

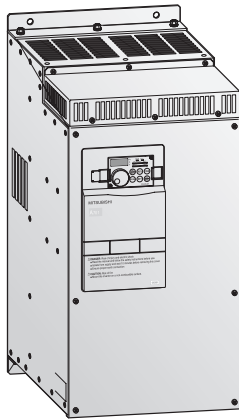

The FR-A741 is the latest addition to the high-performance FR-A700 series. It sets new standards with an integrated power regeneration function that also improves braking performance.

Featuring a large number of innovative technologies, this compact frequency inverter delivers exceptional performance and is ideal for hoist drives and high-powered machines with torque that can be used for regenerative braking.

The advantages over conventional frequency inverter technology are very significant:

- 100 % braking energy infeed
- No braking resistor required
- No external brake transistor required
- Up to 40 % less space for installation needed, depending on the output capacity
- Integrated AC reactor

The FR-A741 is available in the output power range from 5.5 to 55 kW.

All the inverters in the series are designed for connection to three-phase 380 to 500 V (50/60 Hz) power supplies.

The output frequency ranges from 0.2 to 400 Hz.

Product line		FR-A741										
		5.5k	7.5k	11k	15k	18.5k	22k	30k	37k	45k	55k	
Output	Rated current ^① A 200 % overload capacity (ND)	12	17	23	31	38	44	57	71	86	110	
	Rated motor capacity ^① kW 200 % overload capacity (ND)	5.5	7.5	11	15	18.5	22	30	37	45	55	
	Rated output capacity ^② kVA	9.1	13	17.5	23.6	29	32.8	43.4	54	65	84	
	Overload capacity ^③	150 % of rated motor capacity for 60 s; 200 % for 3 s (max. ambient temperature 50 °C)										
	Voltage ^④	3-phase AC, 0 V to power supply voltage										
	Frequency range	Hz 0.2–400										
	Regenerative braking torque	100 % continuous/150 % for 60 s										
Input	Carrier frequency	kHz 0.7–14.5										
	Power supply voltage	3-phase, 380–500 V AC, -15 %/+10 %										
	Voltage range	323–550 V AC at 50/60 Hz										
	Power supply frequency	50/60 Hz ±5 %										
Others	Rated input capacity ^⑤ kVA	12	17	20	28	34	41	52	66	80	100	
	Cooling	Fan cooling										
	Protective structure	IP00										
	Power loss	kW	0.33	0.44	0.66	0.86	1.1	1.29	1.45	1.95	2.36	2.7
	Frequency inverter weight	kg	25	26	37	40	48	49	65	80	83	115
Dimensions (WxHxD)	mm	250x470x270		300x600x294		360x600x320		450x700x340		470x700x368		600x900x405
Order information		Art. no.	216905	216906	216907	216908	216909	217397	216910	216911	216912	216913

Remarks:

- ① The rated motor capacity indicated is the maximum capacity applicable for use of the Mitsubishi Electric 4-pole standard motor.
- ② The rated output capacity indicated assumes that the output voltage is 440 V.
- ③ The % value of the overload capacity indicates the ratio of the overload current to the inverter's rated output current.
For repeated duty, allow time for the inverter and motor to return to or below the temperatures under 100 % load.
- ④ The maximum output voltage does not exceed the power supply voltage. The maximum output voltage can be changed within the setting range.
However, the pulse voltage value of the inverter output side voltage remains unchanged at about $\sqrt{2}$ that of the power supply.
- ⑤ The power supply capacity varies with the value of the power supply side inverter impedance (including those of the input reactor and cables).

Common specifications FR-A700

FR-A740/FR-A741 EC		Description	
Control specifications	Control method	V/F control, advanced magnetic flux vector control and real sensorless vector control)/vector control (when used with option FR-A7AP) ①	
	Modulation control	Sine evaluated PWM, Soft PWM	
	Frequency setting resolution	Analog input	0.015 Hz/0–50 Hz (terminal 2, 4: 0–10 V/12 bit) 0.03 Hz/0–50 Hz (terminal 2, 4: 0–5 V/11 bit, 0–20 mA/11 bit, terminal 1: -10–+10 V/12 bit) 0.06 Hz/0–50 Hz (terminal 1: 0–±5 V/11 bit)
		Digital input	0.01 Hz
	Frequency accuracy	±0.2 % of the maximum output frequency (temperature range 25±10 °C) via analog input; ±0.01 % of the set output frequency (via digital input)	
	Voltage/frequency characteristics	Base frequency adjustable from 0 to 400 Hz; selection between constant torque, variable torque or optional flexible S-point V/f characteristics	
	Starting torque	200 %, 0.3 Hz (0.4–3.7 K), 150 %, 0.3 Hz (5.5 K or more) (under real sensorless vector control or vector control)	
	Torque boost	Manual torque boost	
	Acceleration/deceleration time	0; 0.1–3600 s (can be set individually), linear or S-pattern acceleration/deceleration mode, backlash measures acceleration/deceleration can be selected.	
	Acceleration/deceleration characteristics	Linear or S-form course, user selectable	
	DC injection brake	Operating frequency (0–120 Hz), operating time (0–10 s) and operating voltage (0–30 %) can be set individually. The DC brake can also be activated via the digital input.	
	Stall prevention operation level	Operation current level can be set (0–220 % adjustable), whether to use the function or not can be selected	
	Motor protection	Electronic motor protection relay (rated current user adjustable)	
	Torque limit level	Torque limit value can be set (0 to 400 % variable)	
Control signals for operation	Frequency setting values	Analog input	Terminal 2, 4: 0–5 V DC, 0–10 V DC, 0/4–20 mA Terminal 1: 0–±5 V DC, 0–±10 V DC
		Digital input	Input using the setting dial of the operation panel or parameter unit Four-digit BCD or 16 bit binary (when used with option FR-A7AX)
	Start signal	Available individually for forward rotation and reverse rotation. Start signal automatic self-holding input (3-wire input) can be selected.	
	Input signals	Common	Any of 12 signals can be selected using parameters 178 to 189 (input terminal function selection) from among: multi speed selection, remote setting, stop-on-contact, second function selection, third function selection, terminal 4 input selection, JOG operation selection, selection of automatic restart after instantaneous power failure, flying start, external thermal relay input, inverter operation enable signal (FR-HC/FR-CV connection) ⑤, FR-HC connection (instantaneous power failure detection) ⑤, PU operation/external inter lock signal, external DC injection brake operation start, PID control enable terminal, brake opening completion signal, PU operation/external operation switchover, load pattern selection forward rotation reverse rotation boost, V/F switching, load torque high-speed frequency, S-pattern acceleration/deceleration C switchover, pre-excitation, output stop, start self-holding selection, control mode changing, torque limit selection, start-time tuning start external input, torque bias selection 1, 2 ②, P/PI control switchover, forward rotation command, reverse rotation command, inverter reset, PTC thermistor input, PID forward reverse operation switchover, PU-NET operation switchover, NET-external operation switchover, command source switchover, conditional position pulse train sign ①, conditional position droop pulse clear ①, magnetic flux decay output shutoff ⑥
		Pulse train input	100 kpps
	Output signals	Operating status	Any of 7 signals can be selected using parameter 190 to 196 (output terminal function selection) from among: inverter running, up-to-frequency, instantaneous power failure/undervoltage, overload warning, output frequency (speed) detection, second output frequency (speed) detection, third output frequency (speed) detection, regenerative brake prealarm ⑤, electronic thermal relay function pre-alarm, PU operation mode, inverter operation ready, output current detection, zero current detection, PID lower limit, PID upper limit, PID forward rotation reverse rotation output, commercial power supply-inverter switchover MC1, commercial power supply-inverter switchover MC2, commercial power supply-inverter switchover MC3, orientation completion ①, orientation error ②③, brake opening request, fan fault output, heatsink overheat pre-alarm, inverter running/start command on ⑤, deceleration at an instantaneous power failure, PID control activated, during retry, PID output interruption, position control preparation ready ⑤, life alarm, alarm output 1, 2, 3 (power-off signal), power savings average value update timing, current average monitor, maintenance timer alarm, remote output, forward rotation output ①, reverse rotation output ①, low speed output, torque detection, regenerative status output ①, start-time tuning completion, in-position completion ①, minor fault output and alarm output. Open collector output (5 points), relay output (2 points) and alarm code of the inverter can be output (4 bit) from the open collector
		When using the FR-A7AY, FR-A7AR option	In addition to the above operating modes parameters 313 to 319 (function selection for the additional 7 output terminals) can also be used to assign the following four signals: control circuit capacitor life, main circuit capacitor life, cooling fan life, inrush current limit circuit life (Only positive logic can be set for extension terminals of the FR-A7AR)
		Pulse train output	50 kpps
		Analog output	You can select any signals using Pr. 54 FM terminal function selection (pulse train output) and Pr. 158 AM terminal function selection (analog output) from among output frequency, motor current (steady or peak value), output voltage, frequency setting, operation speed, motor torque, converter output voltage (steady or peak value), electronic thermal relay function load factor, input power, output power, load meter, motor excitation current, reference voltage output, motor load factor, power saving effect, regenerative brake duty ⑤, PID set point, PID measured value, PLC function output ⑤, motor output, torque command, torque current command and torque monitor.
	Display	Parameter unit display (FR-PU07/FR-DU07)	Operating status
Alarm definition			Alarm definition is displayed when the protective function is activated, the output voltage/current/frequency/cumulative energization time right before the protection function was activated and the past 8 alarm definitions are stored.
Interactive guidance		Operation guide/trouble shooting with a help function (FR-PU07 only)	
Protection	Protective functions	Overcurrent during acceleration, overcurrent during constant speed, overcurrent during deceleration, overvoltage during acceleration, overvoltage during constant speed, overvoltage during deceleration, inverter protection thermal operation, motor protection thermal operation, heatsink overheat, instantaneous power failure occurrence, undervoltage, input phase failure, motor overload, output side earth (ground) fault overcurrent, output short circuit, main circuit element overheat, output phase failure, external thermal relay operation ⑤, PTC thermistor operation ⑤, option alarm, parameter error, PU disconnection, retry count excess ⑤, CPU alarm, operation panel power supply short circuit, 24V DC power output short circuit, output current detection value excess ⑤, inrush current limit circuit alarm, communication alarm (inverter), USB error ⑤, opposite rotation deceleration error ⑤, analog input error, fan fault, overcurrent stall prevention, overvoltage stall prevention, regenerative brake prealarm ⑤, electronic thermal relay function prealarm, PU stop, maintenance timer alarm ②④, brake transistor alarm ⑤, parameter write error, copy operation error, operation panel lock, parameter copy alarm, speed limit indication, encoder no-signal ①④, speed deviation large ①④, overspeed ①④, position error large ①④, encoder phase error ①⑤, regeneration converter overcurrent ⑤, regeneration converter circuit fault ⑤, regeneration converter transistor protection thermal ⑤, brake sequence error ④⑥	

Remarks:

- ① Only when the option (FR-A7AP) is mounted
- ② Can be displayed only on the parameter unit (FR-DU07).
- ③ Can be displayed only on the parameter unit (FR-PU07).
- ④ This protective function does not function in the initial status.
- ⑤ FR-A740 only
- ⑥ FR-A741 only

General operating conditions for all inverters

Specifications	FR-D700 SC	FR-E700 SC	FR-F700	FR-A700
Ambient temperature in operation	-10—+50 °C (non-freezing)	-10—+50 °C (non-freezing)	FR-F740: -10—+50 °C; FR-F746: -10—+40 °C (non-freezing) ①	-10—+50 °C (non-freezing)
Storage temperature ②	-20—+65 °C	-20—+65 °C	-20—+65 °C	-20—+65 °C
Ambient humidity	Max. 90 % (non-condensing)	Max. 90 % (non-condensing)	Max. 90 % (non-condensing)	Max. 90 % (non-condensing)
Altitude	Max. 1000 m above sea level	Max. 1000 m above sea level	Max. 1000 m above sea level ③	Max. 1000 m above sea level
Protective structure	Enclosed type IP20	Enclosed type IP20	FR-F740: IP00/IP20 ④ FR-F746: IP54	FR-A740: IP00/IP20 FR-A741: IP00
Shock resistance	10 g (3 times each in 3 directions)	10 g (3 times each in 3 directions)	10 g (3 times each in 3 directions)	10 g (3 times each in 3 directions)
Vibration resistance	Max. 5.9 m/s ²	Max. 5.9 m/s ²	Max. 5.9 m/s ² (2.9 m/s ² or less for the 04320 or above)	Max. 5.9 m/s ² (2.9 m/s ² or less for the FR-A740-04320 or above)
Ambient conditions	For indoor use only, avoid environments containing corrosive gases, install in a dust-free location.	For indoor use only, avoid environments containing corrosive gases, install in a dust-free location.	For indoor use only (F740), avoid environments containing corrosive gases, install in a dust-free location.	For indoor use only, avoid environments containing corrosive gases, install in a dust-free location.
Approvals	UL/CSA/CE/EN/GOST/CCC	UL/CSA/CE/EN/GOST/CCC	FR-F740: CE/UL/cUL/DNV/GOST FR-F746: CE/GOST/CCC	FR-A740: CE/UL/cUL/DNV/GOST/CCC FR-A741: CE/UL/cUL/GOST

Remarks:

- ① For selection of the load characteristics with a 120 % overload rating the max. temperature is 40 °C (F740) and 30 °C (F746).
- ② The product may only be exposed to the full extremes of this temperature range for short periods (e.g. during transportation).
- ③ After that derate by 3 % for every extra 500 m up to 2500 m.
- ④ When the cable bushing for the optional expansion cards is broken out the unit has an IP00 protection rating.

Internal and external options

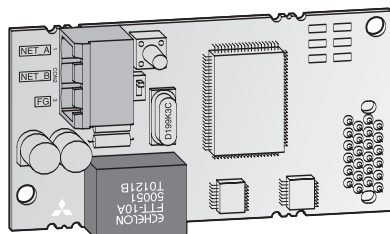

A large number of options allows an individual adoption of the inverter to the according task. The options can be installed quickly and easily. Detailed information on installation and functions is included in the manual of the options.

The options can be divided into two major categories:

- Internal options
- External options

Internal options

The internal options comprise input and output extensions as well as communications options supporting the operation of the inverter within a network or connected to a personal computer or PLC.

External Options

In addition to the FR-PU07 parameter unit that enables interactive operation of the frequency inverter the available external options also include additional EMC noise filters, reactors for improving efficiency and brake units with brake resistors.

Option	Description	FR-D700 SC	FR-E700 SC	FR-F700	FR-A700	
Internal options	Digital input	—	●	●	●	
	Digital output	—	●	●	●	
	Expansion analog output	—	●	●	●	
	Relay output	—	●	●	●	
	Orientation control, encoder feedback control (PLG), vector and master slave control	—	—	—	●	
	Communications	SSCNETIII	—	—	—	●
		Profibus DP	—	●	●	●
		DeviceNet™	—	●	●	●
		CC-Link	—	●	●	●
		CC-Link IE Field	—	—	—	●
LonWorks		—	●	●	●	
Ethernet multi-protocol		—	—	●	●	
RS485 multi-protocol	—	—	●	●		

Option	Description	FR-D700 SC	FR-E700 SC	FR-F700	FR-A700
External options	Parameter unit (8 languages)	●	●	●	●
	FR-Configurator software	●	●	●	●
	EMC noise filter	●	●	●	●
	Brake unit	●	●	●	●
	External high-duty brake resistor	●	●	—	●
	DC reactor AC chokes	●	●	●	●
	Floor standing unit FSU	—	—	●	●
	Filter module	●	●	●	●
	Power feedback unit	●	●	●	●
	Power feedback unit	●	●	●	●
	Communications Profibus DP	●	●	●	●

Overview internal options

Internal options	Description	Remarks/Specifications	Type	Applicable inverter	Art. no.	
16-bit digital input	Interface for the input of the frequency setting via 4-digit BCD or 16-bit binary code, setting of gain and bias supported.	Input: 24 V DC; 5 mA; open collector or switching signal, sink or source logic	FR-A7AX FR-A7AX-Ekit-SC-E	FR-F700, FR-A700 FR-E700 SC-EC	156775 239641	
Digital output with Expansion analog output	Selectable of 43 standard output signals of the inverter can be output at the open collector. The outputs are isolated with optocouplers. Selectable 2 of 18 additional signals (e.g. output frequency, output voltage, output current) can be output and indicated at the analog output. Display on measuring gauge: 20 mA DC or 5 V (10 V) DC	Output: max. 0–10 V DC; 0–20 mA; Resolution: 3 mV at voltage output, 10 mA at current output accuracy: ±10 %	FR-A7AY FR-A7AY-Ekit-SC-E	FR-F700, FR-A700 FR-E700 SC-EC	156776 239642	
Relay output	Selectable 3 of 43 standard output signals of the inverter can be output through relay terminals.	Switching load: 230 V AC/0.3 A, 30 V DC/0.3 A	FR-A7AR FR-A7AR-Ekit-SC-E	FR-F700, FR-A700 FR-E700 SC-EC	156777 239643	
Bipolar analog output 16 bit analog input Motor thermistor input	Selectable among 24 analog output signals Analog input of torque and speed related data Motor thermistor input for torque stability improvement	Bipolar analog output max. 0–(±)10 V DC Bipolar analog input (16 bit) 0–(±)10 V DC	FR-A7AZ	FR-A700	191401	
Encoder power supply	Control terminal block with integrated power supply	12 V DC	FR-A7PS	FR-A700	191399	
Vector control with encoder feedback	Closed loop vector control with encoder can be performed. Encoder feedback enables high-precision speed, torque and position control.	5 V TTL differential 1024–4096 pulse	FR-A7AP	FR-A700	166133	
Master slave control	Closed loop vector control with encoder can be performed. Master slave position and speed synchronisation are possible with command pulse scaling and position control.	11–30 V HTL complementary	FR-A7AL	FR-A700	191402	
Communi- cations	CC-Link	Option board for the integration of a frequency inverter into a CC-Link network. The operation, display functions, and parameter settings can be controlled by a PLC.	Maximum transfer distance: 1200 m (at 156 kBaud)	FR-A7NC FR-A7NC-Ekit-SC-E	FR-F700, FR-A700 FR-E700 SC-EC	156778 239644
	CC-Link IE Field	Option board for the integration of a frequency inverter into a CC-Link IE Field network.	Maximum transfer rate: 1 GBaud	FR-A7NCE	FR-A700	244993
	Ethernet multi-protocol	Ethernet multi-protocol interface card, Modbus TCP, Ethernet/IP, Profinet, BACNet with Modbus RTU		FR-A7N-ETH	FR-F700, FR-A700	212369
	LonWorks	Option board for integration of a frequency inverter in a LonWorks network. Operation, display functions and parameter settings can be controlled by a computer (PC etc.) or a PLC.	Connection of up to 64 inverters supported. Maximum transfer rate: 78 kBaud	FR-A7NL FR-A7NL-Ekit-SC-E	FR-F700, FR-A700 FR-E700 SC-EC	156779 239645
	Profibus DP	Option board for the integration of a frequency inverter into a Profibus DP network. The operation, display functions, and parameter settings can be controlled by a computer (PC etc.) or a PLC.	Connection of up to 126 inverters supported. Maximum transfer rate: 12 MBaud	FR-A7NP	FR-F700, FR-A700	158524
				FR-A7NP-Ekit-SC-E (terminals)	FR-E700 SC-EC	239646
				FR-A7NP-Ekit-01-E (D-Sub9)		235696
			D-Sub9 connection adapter for FR-A7NP	FR-D-Sub9	FR-F700, FR-A700	191751
	DeviceNet™	Option board for the integration of a frequency inverter into a DeviceNet. The operation, display functions, and parameter settings can be controlled by a computer (PC etc.) or a PLC.	Maximum transfer rate: 500 kBaud	FR-A7ND FR-A7ND-Ekit-SC-E	FR-F700, FR-A700 FR-E700 SC-EC	158525 239648
	SSCNETIII	Option board for the integration of a frequency inverter into the Mitsubishi Electric servo system network SSCNETIII. The operation and display functions can be controlled by Motion Controller (Q172H CPU, Q173H CPU).	Maximum transfer rate: 50 MBaud	FR-A7NS	FR-A700	191403
RS485 multi-protocol	RS485 multi-protocol interface card; Siemens FLN and Metasys N2		FR-A7N-XLT	FR-F700, FR-A700	208972	

Mounting example of an internal option

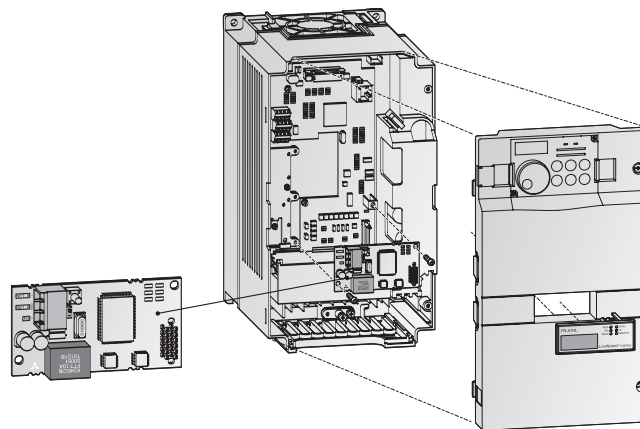

Overview external options

External options	Description	Remarks/Specifications	Type	Applicable inverter	Art. no.	
Parameter unit	Interactive parameter unit with LC display (8 languages) with copy function	Further details are provided by your Mitsubishi Electric Sales office or in the technical catalogue for frequency inverters.	FR-PU07	All	166134	
	Interactive standard parameter unit with copy function		FR-DU07	All	157514	
	For mounting on the switchgear cabinet door (for instance)		FR-PA07	FR-D700 SC-EC, FR-E700 SC-EC	214795	
	Interactive parameter unit with LC display and battery pack		FR-PU07BB	FR-E700 SC-EC, FR-A700	209052	
Adapter	Connection adapter for FR-DU07	Required for remote connection of the FR-DU07 with FR-A5CBL	FR-ADP	FR-A700, FR-F700	157515	
			FR-PU07-01		242151	
Connection cable for remote parameter unit	Cable for a remote connection of a parameter unit	Available length: 1; 2.5 and 5 m	FR-A5 CBL	All	1 m: 70727 2.5 m: 70728 5 m: 70729	
Installation kit for external air cooling	For installation of the heatsink on the switchgear cabinet door	Reduces temperature in switchgear cabinet	FR-A7CN	FR-A700, FR-F700	—	
Distributor module for RJ45 connections	Distributor for connection of multiple inverters in a serial network	2 connections	FR-RJ45-HUB4	FR-A700	167612	
Montageset für externe Kühlluftführung		8 connections	FR-RJ45-HUB10		167613	
Montageset für externe Kühlluftführung		Terminating resistor for RJ45	FR-RJ45-TR		All	167614
Interface cable	Communications cable for RS232 or RS485 interface to connect an external personal computer	Length 3 m	SC-FR PC	All	88426	
USB-RS232 converter	Port converter adapter cable from RS232 to USB	USB specification 1.1, 0.35 m long	USB-RS232	FR-D700 SC, FR-F700	155606	
FR-Configurator	Parameterization and setup software for Mitsubishi Electric inverter.		—	All	215701	
EMC noise filter	Noise filter for compliance with EMC directives.		FFR-□□, FR-, FN-□□	All	—	
du/dt filter	Output filter for du/dt reduction		FFR-DT-□□A-SS1	All	—	
Sinusoidal filter	Output filter for sine wave output voltage		FFR-SI-□□A-SS1	All	—	
AC chokes	For increased efficiency, reduction of mains feedback and compensation of voltage fluctuations.	Further details are provided by your Mitsubishi Electric Sales office or in the technical catalogue for frequency inverters.	FR-BAL-B	FR-D700 SC, FR-E700 SC-EC, FR-F700, FR-A740	—	
DC reactor	DC reactor for compensation of voltage fluctuations.		FR-HEL, FFR-HEL-(H)-E	FR-D700 SC, FR-E700 SC-EC, FR-F700, FR-A740	—	
Brake units	For an improvement of the brake capacity. For high inertia loads and active loads. Used in combination with a resistor unit.		FR-BU2, BU-UFS+RUFC	FR-D700 SC, FR-E700 SC-EC, FR-F700, FR-A740	—	
External high-duty brake resistor	To improve the brake capacity; used in combination with the internal brake transistor.		FR-ABR(H)	FR-D700 SC, FR-E700 SC-EC, FR-A740	—	
Communica-tions	Profibus DP	High speed converter for Profibus DP to RS485 inverter protocol	Base unit with 8 ports	PBDP-GW-G8	All	224915
			Extension unit with 8 ports	PBDP-GW-E8	All	224916

Installing an EMC noise filter on an FR-E700 SC

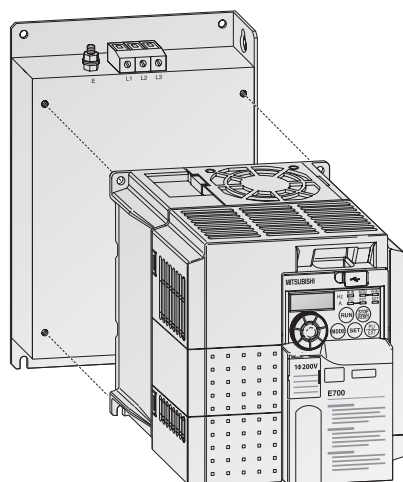

Installing an optional EMC noise filter on an FR-F700

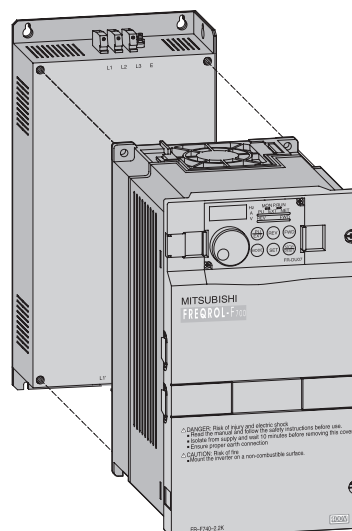

Overview of all inverters and applicable noise filters

Power supply 1~230 V ^①	Power supply 3~400 V ^②	Rated output current [A]	Rated motor capacity [kW] ^③	Rated output current [A] ^④	Rated motor capacity [kW] ^⑤	Rated output current [A] ^⑥	Rated motor capacity [kW] ^⑦	Frequency inverter type	Art. no.	Applicable noise filter ^⑧
		Overload capacity 120 % *		Overload capacity 150 % *		Overload capacity 200 % *				
●		—	—	—	—	0.8	0.1	FR-D720S-008SC EC	247595	D1
●		—	—	—	—	1.4	0.2	FR-D720S-014SC EC	247596	D1
●		—	—	—	—	2.5	0.4	FR-D720S-025SC EC	247597	D1
●		—	—	—	—	4.2	0.75	FR-D720S-042SC EC	247598	D1
●		—	—	—	—	7	1.5	FR-D720S-070SC EC	247599	D2
●		—	—	—	—	10	2.2	FR-D720S-100SC EC	247600	D3
	●	—	—	—	—	1.2 (1.4)	0.4 (0.55)	FR-D740-012SC EC	247601	D4
	●	—	—	—	—	2.2 (2.6)	0.75 (1.1)	FR-D740-022SC EC	247602	D4
	●	—	—	—	—	3.6 (4.3)	1.5 (2.2)	FR-D740-036SC EC	247603	D4
	●	—	—	—	—	5 (6)	2.2 (3)	FR-D740-050SC EC	247604	D5
	●	—	—	—	—	8 (9.6)	3.7 (4)	FR-D740-080SC EC	247605	D5
	●	—	—	—	—	12 (14.4)	5.5 (7.5)	FR-D740-120SC EC	247606	D6
	●	—	—	—	—	16 (19.2)	7.5 (11)	FR-D740-160SC EC	247607	D6
●		—	—	—	—	0.8 (0.8)	0.1	FR-E720S-008SC EC	234795	E1
●		—	—	—	—	1.5 (1.4)	0.2	FR-E720S-015SC EC	234796	E1
●		—	—	—	—	3 (2.5)	0.4	FR-E720S-030SC EC	234797	E1
●		—	—	—	—	5 (4.1)	0.75	FR-E720S-050SC EC	234798	E2
●		—	—	—	—	8 (7)	1.5	FR-E720S-080SC EC	234799	E2
●		—	—	—	—	11 (10)	2.2	FR-E720S-110SC EC	234800	E3
	●	—	—	—	—	1.6 (1.4)	0.4	FR-E740-016SC EC	234801	E4
	●	—	—	—	—	2.6 (2.2)	0.75	FR-E740-026SC EC	234802	E4
	●	—	—	—	—	4.0 (3.8)	1.5	FR-E740-040SC EC	234803	E4
	●	—	—	—	—	6.0 (5.4)	2.2	FR-E740-060SC EC	234804	E5
	●	—	—	—	—	9.5 (8.7)	3.7	FR-E740-095SC EC	234805	E5
	●	—	—	—	—	12	5.5	FR-E740-120SC EC	234806	E6
	●	—	—	—	—	17	7.5	FR-E740-170SC EC	234807	E6
	●	—	—	—	—	23	11	FR-E740-230SC EC	234808	E7
	●	—	—	—	—	30	15	FR-E740-300SC EC	234809	E7
	●	2.3	0.75	2.1	0.75	—	—	FR-F740-00023 EC	156569	AF1
	●	3.8	1.5	3.5	1.5	—	—	FR-F740-00038 EC	156570	AF1
	●	5.2	2.2	4.8	2.2	—	—	FR-F740-00052 EC	156571	AF1
	●	8.3	3.7	7.6	3.7	—	—	FR-F740-00083 EC	156572	AF1
	●	12.6	5.5	11.5	5.5	—	—	FR-F740-00126 EC	156573	AF1
	●	17	7.5	16	7.5	—	—	FR-F740-00170 EC	156594	AF2
	●	25	11	23	11	—	—	FR-F740-00250 EC	156595	AF2
	●	31	15	29	15	—	—	FR-F740-00310 EC	156596	AF3
	●	38	18.5	35	18.5	—	—	FR-F740-00380 EC	156597	AF3
	●	47	22	43	22	—	—	FR-F740-00470 EC	156598	AF4
	●	62	30	57	30	—	—	FR-F740-00620 EC	156599	AF4
	●	77	37	70	37	—	—	FR-F740-00770 EC	156600	AF5
	●	93	45	85	45	—	—	FR-F740-00930 EC	156601	AF6
	●	116	55	106	55	—	—	FR-F740-01160 EC	156602	AF7
	●	180	90	144	75	—	—	FR-F740-01800 EC	156603	AF7
	●	216	110	180	90	—	—	FR-F740-02160 EC	156604	AF8
	●	260	132	216	110	—	—	FR-F740-02600 EC	156605	AF8
	●	325	160	260	132	—	—	FR-F740-03250 EC	156606	AF9
	●	361	185	325	160	—	—	FR-F740-03610 EC	156607	AF9
	●	432	220	361	185	—	—	FR-F740-04320 EC	156608	AF9
	●	481	250	432	220	—	—	FR-F740-04810 EC	156609	AF10
	●	547	280	481	250	—	—	FR-F740-05470 EC	156610	AF10
	●	610	315	547	280	—	—	FR-F740-06100 EC	156611	AF10
	●	683	355	610	315	—	—	FR-F740-06830 EC	156612	AF11
	●	770	400	683	355	—	—	FR-F740-07700 EC	156613	AF11
	●	866	450	770	400	—	—	FR-F740-08660 EC	156614	AF11
	●	962	500	866	450	—	—	FR-F740-09620 EC	156615	AF11
	●	1094	560	962	500	—	—	FR-F740-10940 EC	156616	AF12
	●	1212	630	1094	560	—	—	FR-F740-12120 EC	156617	AF12

Power supply 3~400 V ②	Rated out-put current [A] ⑥	Rated motor capacity [kW] ⑥	Rated out-put current [A] ⑥	Rated motor capacity [kW] ⑥	Rated out-put current [A]	Rated motor capacity [kW] ⑥	Rated out-put current [A]	Rated motor capacity [kW] ⑥	Frequency inverter type	Art. no.	Applicable noise filter ⑥
	Overload capacity 120 % *		Overload capacity 150 % *		Overload capacity 200 % *		Overload capacity 250 % *				
●	2.3	0.75	2.1	0.75	—	—	—	—	FR-F746-00023 EC	163796	F1
●	3.8	1.5	3.5	1.5	—	—	—	—	FR-F746-00038 EC	163797	F1
●	5.2	2.2	4.8	2.2	—	—	—	—	FR-F746-00052 EC	163798	F1
●	8.3	3.7	7.6	3.7	—	—	—	—	FR-F746-00083 EC	163799	F1
●	12.6	5.5	11.5	5.5	—	—	—	—	FR-F746-00126 EC	163800	F1
●	17	7.5	16	7.5	—	—	—	—	FR-F746-00170 EC	163801	F2
●	25	11	23	11	—	—	—	—	FR-F746-00250 EC	163802	F2
●	31	15	29	15	—	—	—	—	FR-F746-00310 EC	163803	F3
●	38	18.5	35	18.5	—	—	—	—	FR-F746-00380 EC	163804	F3
●	47	22	43	22	—	—	—	—	FR-F746-00470 EC	163805	F4
●	62	30	57	30	—	—	—	—	FR-F746-00620 EC	163806	F4
●	77	37	70	37	—	—	—	—	FR-F746-00770 EC	163807	F5
●	93	45	85	45	—	—	—	—	FR-F746-00930 EC	163808	F6
●	116	55	106	55	—	—	—	—	FR-F746-01160 EC	163809	F6
●	2.3	0.75	2.1	0.75	1.5	0.4	0.8	0.25	FR-A740-00023 EC	169826	AF1
●	3.8	1.5	3.5	1.5	2.5	0.75	1.5	0.4	FR-A740-00038 EC	169797	AF1
●	5.2	2.2	4.8	2.2	4	1.5	2.5	0.75	FR-A740-00052 EC	169798	AF1
●	8.3	3.7	7.6	3.7	6	2.2	4	1.5	FR-A740-00083 EC	169799	AF1
●	12.6	5.5	11.5	5.5	9	3.7	6	2.2	FR-A740-00126 EC	169800	AF1
●	17	7.5	16	7.5	12	5.5	9	3.7	FR-A740-00170 EC	169801	AF2
●	25	11	23	11	17	7.5	12	5.5	FR-A740-00250 EC	169802	AF2
●	31	15	29	15	23	11	17	7.5	FR-A740-00310 EC	169803	AF3
●	38	18.5	35	18.5	31	15	23	11	FR-A740-00380 EC	169804	AF3
●	47	22	43	22	38	18.5	31	15	FR-A740-00470 EC	169805	AF4
●	62	30	57	30	44	22	38	18.5	FR-A740-00620 EC	169806	AF4
●	77	37	70	37	57	30	44	22	FR-A740-00770 EC	169807	AF5
●	93	45	85	45	71	37	57	30	FR-A740-00930 EC	169808	AF6
●	116	55	106	55	86	45	71	37	FR-A740-01160 EC	169809	AF7
●	180	90	144	75	110	55	86	45	FR-A740-01800 EC	169810	AF7
●	216	110	180	90	144	75	110	55	FR-A740-02160 EC	169811	AF8
●	260	132	216	110	180	90	144	75	FR-A740-02600 EC	169812	AF8
●	325	160	260	132	216	110	180	90	FR-A740-03250 EC	169813	AF9
●	361	185	325	160	260	132	216	110	FR-A740-03610 EC	169814	AF9
●	432	220	361	185	325	160	260	132	FR-A740-04320 EC	169815	AF9
●	481	150	432	220	361	185	325	160	FR-A740-04810 EC	169816	AF10
●	547	280	481	250	432	220	361	185	FR-A740-05470 EC	169817	AF10
●	610	315	547	280	481	250	432	220	FR-A740-06100 EC	169818	AF10
●	683	355	610	315	547	280	481	250	FR-A740-06830 EC	169819	AF11
●	770	400	683	355	610	315	547	280	FR-A740-07700 EC	169820	AF11
●	866	450	770	400	683	355	610	315	FR-A740-08660 EC	169821	AF11
●	962	500	866	450	770	400	683	355	FR-A740-09620 EC	169822	AF11
●	1094	560	962	500	866	450	770	400	FR-A740-10940 EC	169823	AF12
●	1212	630	1094	560	962	500	866	450	FR-A740-12120 EC	169824	AF12
●	—	—	—	—	12	5.5	—	—	FR-A741-5.5k	216905	AF13
●	—	—	—	—	17	7.5	—	—	FR-A741-7.5k	216906	AF13
●	—	—	—	—	23	11	—	—	FR-A741-11k	216907	AF14
●	—	—	—	—	31	15	—	—	FR-A741-15k	216908	AF14
●	—	—	—	—	38	18.5	—	—	FR-A741-18.5k	216909	AF15
●	—	—	—	—	44	22	—	—	FR-A741-22k	217397	AF15
●	—	—	—	—	57	30	—	—	FR-A741-30k	216910	AF16
●	—	—	—	—	71	37	—	—	FR-A741-37k	216911	AF16
●	—	—	—	—	86	45	—	—	FR-A741-45k	216912	AF16
●	—	—	—	—	110	55	—	—	FR-A741-55k	216913	AF17

The values for 120 % overload capacity are valid at 110 % I_{rated} for 60 s, 120 % for 0.5 s (3 s for FR-F740 and FR-F746) at 40 °C ** max. (30 °C for FR-F746)
 The values for 150 % overload capacity are valid at 120 % I_{rated} for 60 s, 150 % for 0.5 s (3 s for FR-F740 and FR-F746) at 40 °C ** max.
 The values for 200 % overload capacity are valid at 150 % I_{rated} for 60 s, 200 % for 0.5 s at 50 °C max. (3 s for FR-A740/FR-A741) at 50 °C max.
 The values for 250 % overload capacity are valid at 200 % I_{rated} for 60 s, 250 % for 3 s at 50 °C max.
 ** (FR-A540L-G and FR-F740 do not have this limitation, the validity is 50 °C max. at 150 % overload capacity)

Remarks:

- ① Permissible power supply voltage range for 1-phase connection: 170–264 V.
- ② Permissible power supply voltage range for 3-phase connection: 323–528 V (323–550 V for FR-F740-01800–12120)
- ③ The values in brackets are valid without a restriction to the PWM frequency (up to 40 °C).
- ④ At higher power supply voltages higher capacities can be output. The motor capacity ratings in brackets are for ambient temperatures up to 40 °C.
- ⑤ Combination see next page.
- ⑥ If the carrier of the FR-F 740 is set to 3 kHz or more, the carrier frequency is automatically reduced when the inverter output current exceeds the parenthesized rated output current (= 85 % load).

EMC filter and electromagnetic compatibility

1st and 2nd environment

Different interference levels are permissible depending on the place of use. Differentiation is made between 1st and 2nd environment. The first environment includes residential and business areas which are connected directly to the low-voltage network, i.e. which are not supplied via dedicated high-voltage or medium-voltage transformers. In contrast, the second environment is not connected directly to the public low-voltage network. The second environment is also referred to as the industrial environment.

Norms and directives

The limits for the respective environments are specified in norms. The environmental norm EN 55011 defines the limits of the basic environments in the industrial area with Classes A1 and A2 and in the residential area with Class B. In addition, the product norm EN 61800-3 for electrical drive systems, which defines the new categories C1 to C4, has been in force since June 2007.

No.	Frequency inverter	EMC Filter conf. 55011A	Art. no.	EMC Filter conf. 55022B	Art. no.
D1	FR-D720S-008-042SC EC	FFR-CS-050-14A-RF1	216227	FFR-CS-050-14A-RF1	216227
		FFR-CS-050-14A-RF1-LL*	229801	FFR-CS-050-14A-RF1-LL*	229801
D2	FR-D720S-070SC EC	FFR-CS-080-20A-RF1	216228	FFR-CS-080-20A-RF1	216228
		FFR-CS-080-20A-RF1-LL*	229802	FFR-CS-080-20A-RF1-LL*	229802
D3	FR-D720S-100SC EC	FFR-CS-110-26A-RF1	216229	FFR-CS-110-26A-RF1	216229
		FFR-CS-110-26A-RF1-LL*	229803	FFR-CS-110-26A-RF1-LL*	229803
D4	FR-D740-012-036SC EC	FFR-CSH-036-8A-RF1	215007	FFR-CSH-036-8A-RF1	215007
		FFR-CSH-036-8A-RF1-LL*	226836	FFR-CSH-036-8A-RF1-LL*	226836
D5	FR-D740-050/080SC EC	FFR-CSH-080-16A-RF1	215008	FFR-CSH-080-16A-RF1	215008
		FFR-CSH-080-16A-RF1-LL*	226837	FFR-CSH-080-16A-RF1-LL*	226837
D6	FR-D740-120/160SC EC	FFR-MSH-170-30A-RF1	215005	FFR-MSH-170-30A-RF1	215005
		FFR-MSH-170-30A-RF1-LL*	226838	FFR-MSH-170-30A-RF1-LL*	226838
E1	FR-E720S-008-030SC EC	FFR-CS-050-14A-RF1	216227	FFR-CS-050-14A-RF1	216227
		FFR-CS-050-14A-RF1-LL*	229801	FFR-CS-050-14A-RF1-LL*	229801
E2	FR-E720S-050/080SC EC	FFR-CS-080-20A-RF1	216228	FFR-CS-080-20A-RF1	216228
		FFR-CS-080-20A-RF1-LL*	229802	FFR-CS-080-20A-RF1-LL*	229802
E3	FR-E720S-110SC EC	FFR-CS-110-26A-RF1	216229	FFR-CS-110-26A-RF1	216229
		FFR-CS-110-26A-RF1-LL*	229803	FFR-CS-110-26A-RF1-LL*	229803
E4	FR-E740-016-040SC EC	FFR-MSH-040-8A-RF1	214953	FFR-MSH-040-8A-RF1	214953
E5	FR-E740-060/095SC EC	FFR-MSH-095-16A-RF1	215004	FFR-MSH-095-16A-RF1	215004
E6	FR-E740-120/170SC EC	FFR-MSH-170-30A-RF1	215005	FFR-MSH-170-30A-RF1	215005
E7	FR-E740-230/300SC EC	FFR-MSH-300-50A-RF1	215006	FFR-MSH-300-50A-RF1	215006
AF1	FR-A/F740-00023-00126 EC	FFR-BS-00126-18A-SF100	193677	FFR-BS-00126-18A-SF100	193677
AF2	FR-A/F740-00170-00250 EC	FFR-BS-00250-30A-SF100	193678	FFR-BS-00250-30A-SF100	193678
AF3	FR-A/F740-00310-00380 EC	FFR-BS-00380-55A-SF100	193679	FFR-BS-00380-55A-SF100	193679
AF4	FR-A/F740-00470-00620 EC	FFR-BS-00620-75A-SF100	193680	FFR-BS-00620-75A-SF100	193680
AF5	FR-A/F740-00770 EC	FFR-BS-00770-95A-SF100	193681	FFR-BS-00770-95A-SF100	193681
AF6	FR-A/F740-00930 EC	FFR-BS-00930-120A-SF100	193682	FFR-BS-00930-120A-SF100	193682
AF7	FR-A/F740-01160-01800 EC	FFR-BS-01800-180A-SF100	193683	FFR-BS-01800-180A-SF100	193683
AF8	FR-A/F740-02160-02600 EC	FN3359-250-28	104663		
AF9	FR-A/F740-03250-04320 EC	FN3359-400-99	104664		
AF10	FR-A/F740-04810-06100 EC	FN3359-600-99	104665		
AF11	FR-A/F740-06830-09620 EC	FN3359-1000-99	104666		
AF12	FR-A/F740-10940-12120 EC	FN3359-1600-99	130229		
F1	FR-F746-00023-00126 EC	FFR-AF-IP54-21A-SM2	201551	FFR-AF-IP54-21A-SM2	201551
F2	FR-F746-00170-00250 EC	FFR-AF-IP54-44A-SM2	201552	FFR-AF-IP54-44A-SM2	201552
F3	FR-F746-00310-00380 EC	FFR-AF-IP54-62A-SM2	201553	FFR-AF-IP54-62A-SM2	201553
F4	FR-F746-00470-00620 EC	FFR-AF-IP54-98A-SM2	201704	FFR-AF-IP54-98A-SM2	201704
F5	FR-F 746-00770 EC	FFR-AF-IP54-117A-SM2	201705	FFR-AF-IP54-117A-SM2	201705
F6	FR-F746-00930-01160 EC	FFR-AF-IP54-172A-SM2	201706	FFR-AF-IP54-172A-SM2	201706
AF13	FR-A741-5.5k/7.5k	FFR-RS-7.5k-27A-EF100	227840	FFR-RS-7.5k-27A-EF100	227840
AF14	FR-A741-11k/15k	FFR-RS-15k-45A-EF100	227841	FFR-RS-15k-45A-EF100	227841
AF15	FR-A741-18.5k/22k	FFR-RS-22k-65A-EF100	227842	FFR-RS-22k-65A-EF100	227842
AF16	FR-A741-30k/37k/45k	FFR-RS-45k-127A-EF100	227843	FFR-RS-45k-127A-EF100	227843
AF17	FR-A741-55K	FFR-RS-55k-159A-EF100	227844	FFR-RS-55k-159A-EF100	227844

Remark:

The frequency inverters of the FR-F740/FR-F746/FR-A740 series are equipped with a built-in EMC filter for industrial environment (2nd environment). The filters shown in the table above are required for special cases only.
 * LL filters allow a lower leakage current for portable machines, that are connected with a plug to the power supply, e.g. mixers (23.5 mA with short motor cables (1.10 m)). The LL filters are available for FR-D720S, D740 and FR-FR-E720S SC.

Servo and Motion Systems

Mitsubishi Electric offers a variety of Servo and Motion system products providing solutions for applications covering point-to-point and synchronised systems. Systems can be built using a single axis or multi axes, for example when using a MELSEC System Q Motion CPU solution up to 96 axes can be controlled.

With both standard pulse type output modules and SSCNET bus modules specific application needs are easy to meet.

The Servo motors and amplifiers take Mitsubishi Electric Motion Control to new levels of precision with a wide range of motors and a wide range of amplifiers (up to 110 kW). All MR-ES series motors are fitted with

131072 pulse-per-revolution encoders, all MR-J3 series motors with 262144 pulse-per-revolution encoders, all MR-J4 series motors with 4,194,304 pulse-per-revolution encoders. All Mitsubishi Electric Servo and Motion system hardware is complimented by a range of software packages allowing easy programming and set-up of the units.

What are the components of a MR-J4 servo system?

Servo motors

Utilising the most advanced concentrated winding techniques and latest technology, these brushless servo motors are among the most compact on the market.

Mitsubishi Electric Servo Motors are made to high standards and offer a wide range of power, speed and inertia ratings providing a motor for all applications. With a range from 50 W to 110 kW and with a considerable number of motor types like rotary, linear and direct drive servo motors a complete line-up of products can be offered by Mitsubishi Electric.

Also, all motors in the MR-J4 series are fitted with absolute encoders as standard. Therefore, an absolute position system can be created by simply providing power to Servo amplifier via a battery. Once this has been done the super capacitor inside the motor and back-up battery allow the Servomotor position to be constantly monitored.

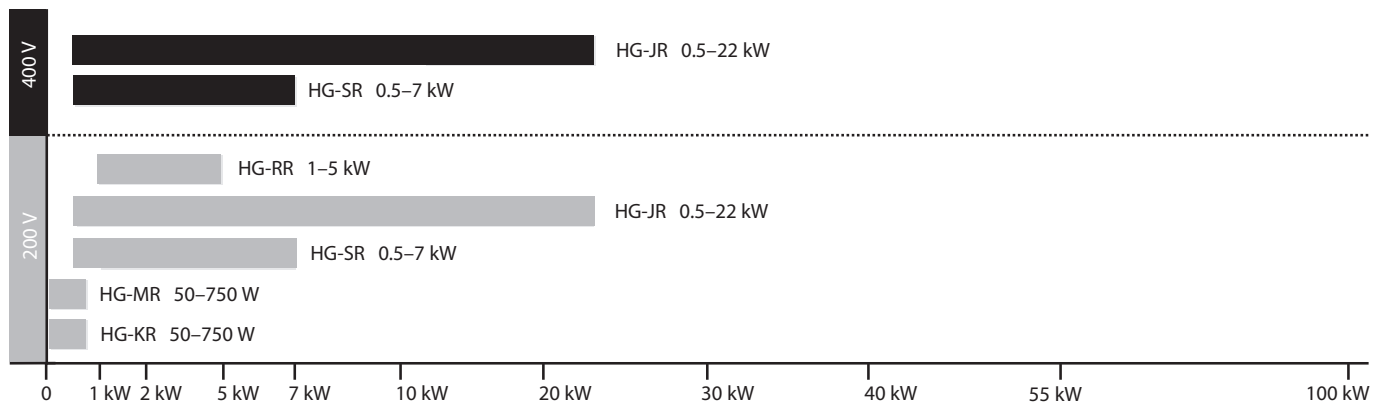

Improving machine performance with high-performance motors

To raise your machine on a high productive level, you need not only powerful servo amplifiers but also high performance servo motors. These motors have to support the high encoder resolution of 22 bits with the MR-J4 series for improved accuracy and speed. Fully closed loop control is supported as standard. A variety of models is available to match various applications.

Rotary servo motors achieve high-accuracy, high-torque output during high speed positioning and smooth rotation with a high resolution encoder and improved processing speed. Linear servo motors support highly accurate tandem synchronous control. Direct drive motors are used for compact and rigid machine and high-torque operations.

For rough environment conditions some motor series are also available with higher protection class like IP65 or IP67.

The MR-J4 series servo amplifiers are able to operate rotary servo motors, linear servo motors, and direct drive motors as standard.

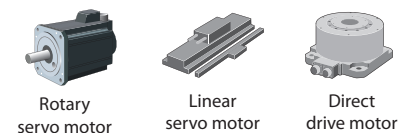
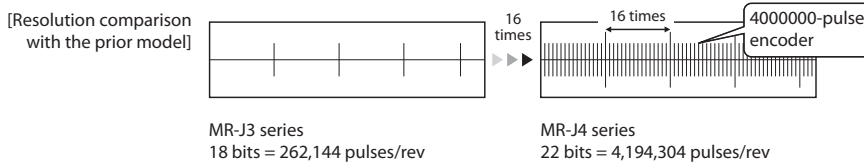

Servo amplifiers

Mitsubishi Electric offers a wide range of Servo amplifiers to meet the demands of all types of applications. From standard digital pulse and analogue controlled amplifiers through to dedicated SSCNETIII bus type amplifiers, there is a product for all circumstances.

Real Time Adaptive Tuning (RTAT) is a unique Mitsubishi Electric technology, enabling the servo to deliver maximum dynamic performance, even if the load keeps changing, by automatically tuning online (during operation) to the application.

The digital pulse-train and analogue units of the MR-ES and the MR-J4 series from 100 W to 22 kW. The SSCNETIII/H bus type amplifiers (type MR-J4-B) offer the user ease of connectivity, via SSCNETIII.

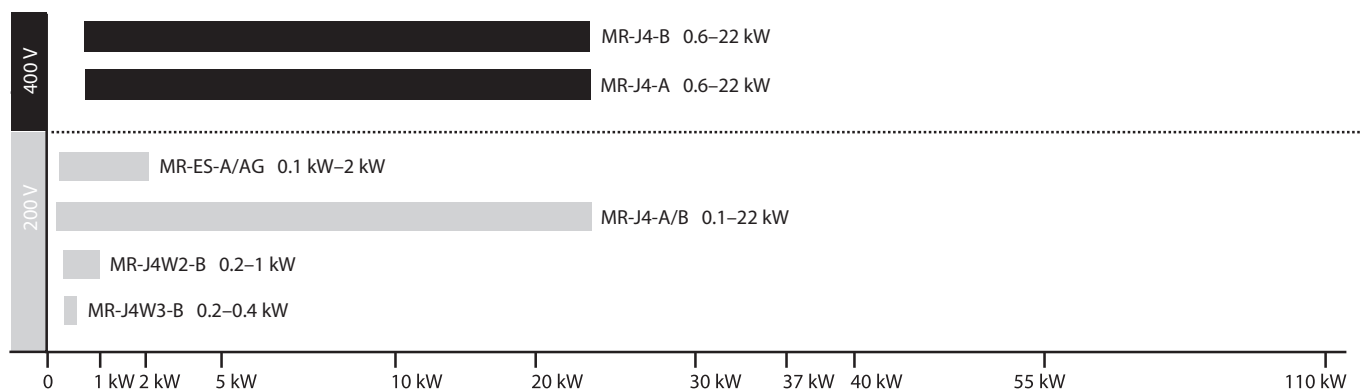

Positioning controllers

For the compact, cost effective, FX range of PLCs, the FX2N-10PG unit provides single-axis control with built-in positioning tables, fast external start and an output pulse rate of up to 1 MHz. The module FX3U-20SSC-H is a positioning module for the MR-J4-B series. This module provides a quick and easy, but efficient positioning control system for simpler applications.

For larger and more complex applications the L-series and the MELSEC System Q provide numerous positioning and Simple motion modules (1, 2, 4 and 16 axes).

These are: open-collector output type (LD75P/QD75P series), Differential output type (LD75D/QD75D series) and SSCNETIII bus type (LD77MH/QD75MH), SSCNETIII/H bus type (QD77MS). Using the SSCNETIII system can provide much improved, easier to use positioning systems, with reduced wiring and better noise immunity. All positioning modules provide functions such as interpolation, speed control and positioning operations, etc. For advanced motion applications like axes synchronisation and CAM control the Simple Motion modules (LD77/QD77) are available.

Motion Controllers

For specialist applications requiring the highest level of control and precision, the dynamic servo technology provided by the Q-Motion CPU is combined with the powerful processing power of the MELSEC System Q PLC CPU, creating a completely new generation of motion controller products.

This fully integrated and flexible system has the capability to control up to 96 axes using SSCNETIII, which is more than capable for handling any motion application.

Advanced one-touch tuning function

Servo gain adjustment for precise vibration suppression control can be done only by one touch. Machine resonance suppression filter, advanced vibration suppression control II (adjustment for one frequency), and robust filter are adjusted just by turning on this function. The advanced vibration suppression control function enables the machine to operate with high speed at the highest performance.

Advanced vibration suppression control II

The vibration suppression algorithm supports a three-inertia system so that two types of low frequency vibrations are suppressed at the same time. For adjustment the setup software MR Configurator2 is used. This function is effective in suppressing vibration at the end of an arm and in reducing residual vibration in a machine. Droop pulses are reduced to a minimum.

Machine diagnosis function

This function is a powerful monitoring and maintenance support tool. It detects changes of machine parts (ball screw, guide, bearing, belt, etc.) by analyzing machine friction, load moment of inertia, unbalanced torque, and changes in vibration component from the data inside the servo amplifier. Monitoring is done with the setup software MR Configurator2. Timely maintenance of wear parts will be indicated before breakdown.

Multi-axis servo amplifier

2-axis and 3-axis servo amplifiers are available for operating two and three servo motors, respectively. They are designed to cut waste and save on space, wiring, and energy use. The 2-axis servo amplifier MR-J4W2-B requires 26 % less installation space than two units of MR-J4-B, and the 3-axis servo amplifier MR-J4W3-B requires 30% less installation space than three units of MR-J4-B. Wiring of the 3-axis type is reduced by approx. 50 %, because the three axes use

the same connections for main and control circuit power, peripheral equipment, control signal wire, etc. These multi-axis servo amplifiers enable energy-conservative and compact machine design at lower cost. Different types of servo motors including rotary servo motors, linear servo motors, and direct drive motors are freely combined as long as the servo motors are compatible with the servo amplifier.

MR-J3-□A

(General-purpose interface compatible)

Pulse train and analog input, etc., are provided as a standard for the command interface. The control mode can be switched accordingly for position, speed or torque control.

MR-J3-□BSafety

(SSCNETIII compatible/Drive safety compatible/Fully closed loop control)

STO (Safe torque off) function is provided as a safety function. SS1 function is also supported by using the optional module MR-J3-D05. Fully closed loop control is also supported.

MR-J3-□T

(CC-Link compatible/Built-in positioning function)

The built-in positioning function sets position and speed data in the point tables in the servo amplifier. Positioning operation can be started using start signals from a host controller.

MR-J3-□A-EtherCAT

(EtherCAT compatible)

This is an AC servo amplifier based on the MR-J3-□A series, and is compatible with high speed communication through the open network EtherCAT. The drive supports CANopen over EtherCAT (CoE) CiA402 Drive Profile with PDO communication cycle time of 500 μs, 1 ms, 2 ms.

Specifications	MR-J3-□A	MR-J3-□BSafety	MR-J3-□T	MR-J3-□A-EtherCAT
Command interface	Pulse train/Analog/RS422 multi-drop	SSCNETIII	CC-Link/DIO/RS422 multi-drop pulse train	EtherCAT
Control mode	Position/Speed/Torque	Position/Speed/Torque/Fully closed loop control	Position/Speed/Torque/Built-in Positioning function	Home position return, Position, Speed
Power specifications	1-phase 200 V AC/ 3-phase 200 V AC/ 3-phase 400 V AC	1-phase 200 V AC/ 3-phase 200 V AC/ 3-phase 400 V AC	1-phase 200 V AC/ 3-phase 200 V AC/ 3-phase 400 V AC	1-phase 200 V AC/ 3-phase 200 V AC/ 3-phase 400 V AC
Capacity range	100 W to 55 kW	100 W to 55 kW	100 W to 22 kW	100 W to 22 kW

For order information, please contact your Mitsubishi Electric representative

A wide range of capacities and series for various system applications

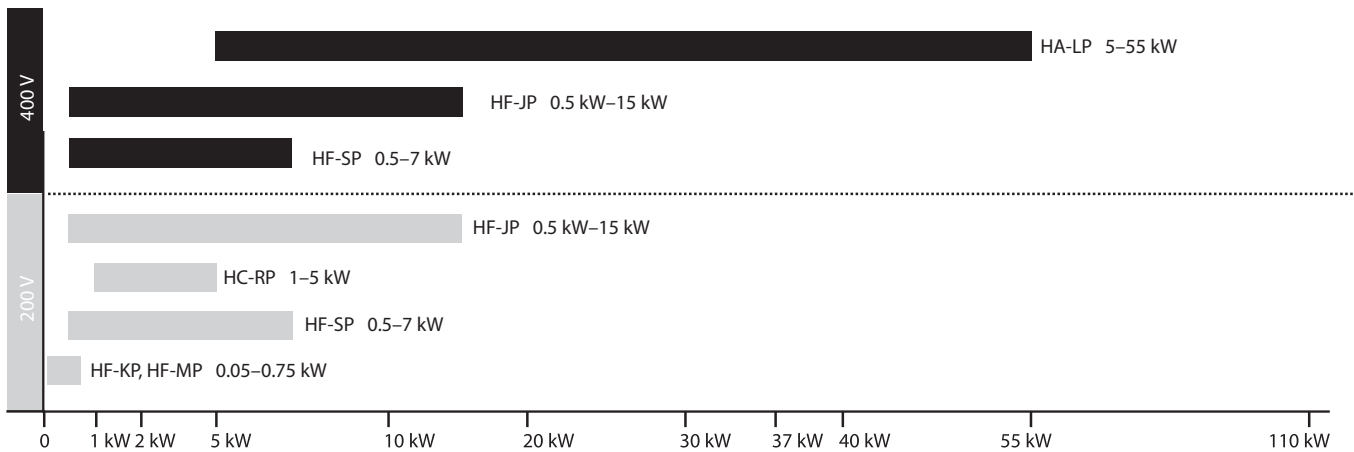

System configuration

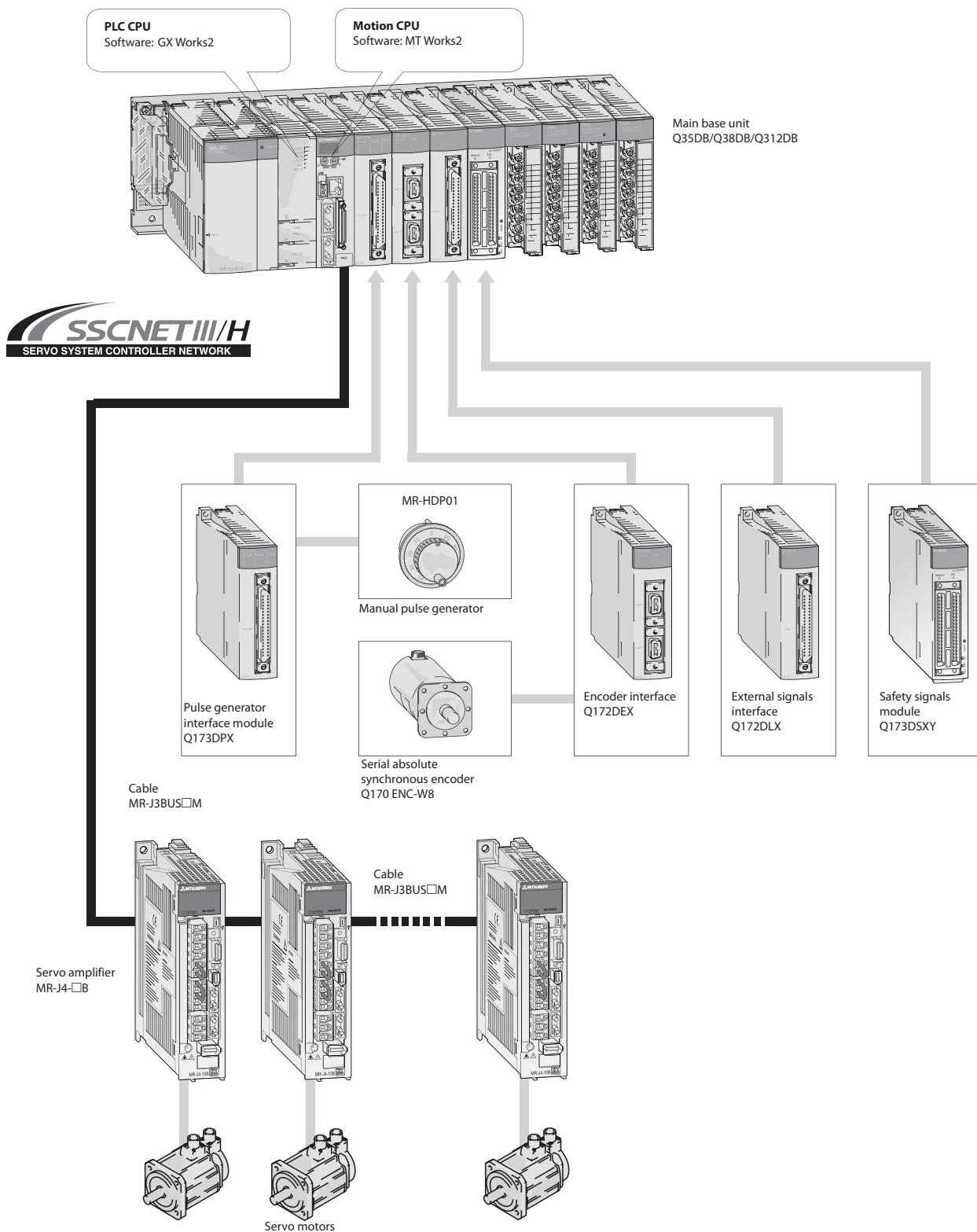

Notes:

1. The first CPU on the main base unit must always be a PLC CPU (e.g. Q□UD(E)(H) series).

X-Y table system configurations

An X-Y table is a typical two axes servo application, commonly used in industry for pick and place systems such as PCB component insertion machines through to welding machines.

The following information provides two examples of possible X-Y table system configurations, using Mitsubishi Electric automation equipment.

The first is a FX3G-24MT/ESS based system and the second is a more complex interpolating QD77MS2 (SSCNETIII/H) based system.

System 1: FX3G PLC based system

Products	Function
FX3G-24MT/ESS	PLC with integrated positioning control
MR-E-10A-QW003	Servo amplifier
HF-KN13	Motor
MR-E-70A-QW003	Servo amplifier
HF-SN52JK	Motor

The FX3G is a compact PLC for comprehensive machine control. It combines the functions of a PLC with positioning functions. In this configuration the FX3G-24MT/ESS is used to control the X and Y axes. Via the transistor open collector outputs the PLC provides the Servo amplifiers of the MR-ES-A Series with pulse train signals for controlling the two axes. The setting of the system can be done with the GX Works2

GX Works2 has a special section for the general positioning parameter setup and for the setup of each positioning command in a easy to use table. This table for each axis can contain 100 instructions

with the Frequency and number of pulses stored in the user data area and can be manipulated and uploaded for setting into operation of the machine.

For expanding the system, the FX3G is also connectable to the majority of existing FX2N and FX3U Special Function Blocks.

- User friendly positioning
- Easy setting in GX Works2
- Cost effective
- Simple functionality

System 2: QD77MS2 based system

Products	Function
Q00J	Q PLC
QD77MS2	Simple motion module
MR-J4-10B	Servo amplifier
HG-KR13	Motor
MR-J4-60B	Servo amplifier
HG-SR52	Motor
MR-BAT6V1SET	Servo amplifier battery

The QD77MS2 based system uses the powerful modular Qn PLC Series, providing greater functionality and expandability options. The QD77MS2 system is connected using SSCNETIII/H (Servo System Controller Network), which is Mitsubishi Electric's dedicated motion control network. SSCNETIII/H simplifies the set-up of the system and reduces the wiring required. SSCNETIII/H systems are created by simply plugging an amplifier into the main controller (QD77MS2) and then "daisy-chaining" each additional axis that is added. SSCNETIII/H connectivity requires MR-J4-B type amplifiers to be used.

Furthermore, as the Servo amplifiers are connected by a bus system, all Servo data, such as current position, torque etc. can all be monitored back at the main controller (Q00J PLC) as the data is automatically updated on the QD77MS2 module.

Also, all of the internal Servo parameters can be set from the PLC, again due to the bus system used.

The bus system also means that position data is sent serially, therefore reducing any possible interference due to noise.

Finally, as both axes are controlled from one high function module (QD77MS2), interpolation between the two axes is possible.

- SSCNETIII/H capability
- Easy of set-up
- High functionality
- Expandability
- Module options
- Reduced wiring

X-Y table control

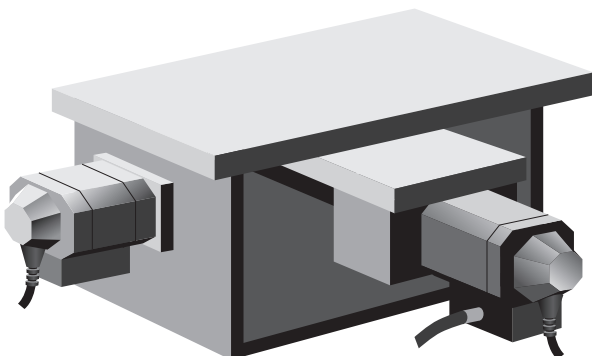

Servo motor features and typical applications

The recommended combinations of servo amplifiers and servo motors are listed in the tables below.

All servo motors are fitted with an absolute encoder and optionally available with an electromagnetic brake.

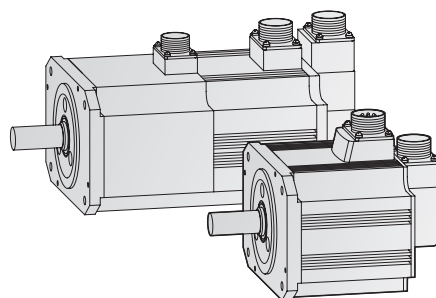

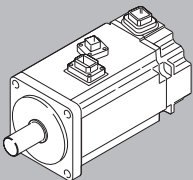
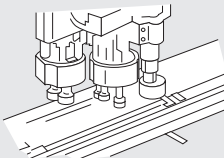
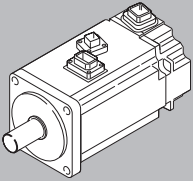
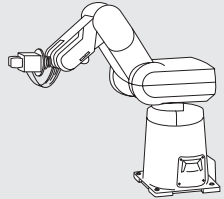
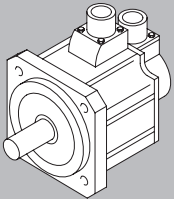
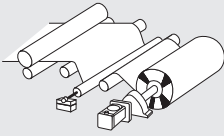
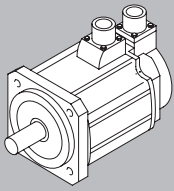
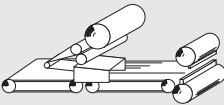
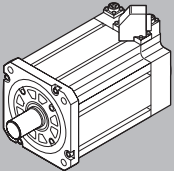
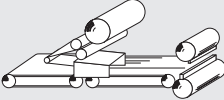
Model designation	Features	Application example	
M 	Ultra low inertia Small motor inertia moment makes this unit well suited for high-dynamic positioning operations with extra small cycle times.	<ul style="list-style-type: none"> ● Inserters, mounters, bonders ● Printed board hole openers ● In-circuit testers ● Label printers ● Knitting and embroidery machinery ● Ultra-small robots and robot tips 	 Inserters, mounters, bonders
K 	Low inertia Larger motor inertia moment makes this unit well suited for machines with fluctuating load inertia moment or machines with low rigidity such as conveyors.	<ul style="list-style-type: none"> ● Conveyors ● Food preparation machinery ● Printers ● Small loaders and unloaders ● Small robots and component assembly devices ● Small X-Y tables ● Small press feeders 	 Small robots
S 	Medium inertia Stable control is performed from low to high speeds, enabling this unit to handle a wide range of applications (e.g. direct connection to ball screw components).	<ul style="list-style-type: none"> ● Conveyor machinery ● Specialised machinery ● Robots ● Loaders and unloaders ● Winders and tension devices ● Turrets ● X-Y tables ● Test devices 	 Winders and tension devices
R 	Low inertia A compact sized low-inertia moment model with medium capacity. Well suited for high-frequency operation.	<ul style="list-style-type: none"> ● Roll feeders ● Loaders and unloaders ● High-frequency conveyor machinery 	 Roll feeders
J 	Low Inertia (400 V) A 400 V Servo Motor for the MELSERVO-J3 Series for a power range up to 9 kW with low inertia and high speed. It has a compact size, is equipped with high resolution encoder and is compatible to global standards.	<ul style="list-style-type: none"> ● Food and Packaging ● Printing machine ● Pick up robot for Injection molding machine ● Palletizing machine ● General machine which require High speed and High frequency 	 Wrapping machinery

Note:
Other types of motors are available on request.

Servo motors overview

Motors for MR-J4 series servo amplifiers (200 V)

Motor series 200 V	Rated speed [r/min]	Max. speed [r/min]	Rated torque [Nm]	Max. torque [Nm]	Moment of inertia J [x10 ⁻⁴ kg m ²]	Rated output capacity [kW]	Servo motor model	Servo motor type		Amplifier pairing MR-J4																	
								Voltage	Protective structure	10	20	40	60	70	100	200	350	500	700	11K	15K	22K	Art. no.				
HG-MR M	3000	6000	0.16	0.48	0.0162	0.05	HG-MR053	200 V AC	IP65	●														248661			
			0.32	0.95	0.0300	0.10	HG-MR13			●															248662		
			0.64	1.9	0.0865	0.20	HG-MR23				●															248663	
			1.3	3.8	0.142	0.40	HG-MR43					●														248664	
			2.4	7.2	0.586	0.75	HG-MR73						●														248665
HG-KR K	3000	6000	0.16	0.56	0.0450	0.05	HG-KR053	200 V AC	IP65	●															248651		
			0.32	1.1	0.0777	0.10	HG-KR13			●																248652	
			0.64	2.2	0.221	0.20	HG-KR23				●															248653	
			1.3	4.5	0.371	0.40	HG-KR43					●														248654	
			2.4	8.4	1.26	0.75	HG-KR73						●														248655
HG-SR S	2000	3000	2.4	7.2	7.26	0.50	HG-SR52	200 V AC	IP67				●												248671		
			4.8	14.3	11.6	1.00	HG-SR102							●											248672		
			7.2	21.5	16.0	1.50	HG-SR152								●											248673	
			9.5	28.6	46.8	2.00	HG-SR202									●											248674
			16.7	50.1	78.6	3.50	HG-SR352										●										248675
			23.9	71.6	99.7	5.00	HG-SR502											●									248676
			33.4	100	151	7.00	HG-SR702												●								248677
HG-JR J	3000	6000	1.6	4.8 <6.4> ^①	1.52	0.5	HG-JR53	200 V AC	IP67 ^④				●			● ^②										261539	
			2.4	7.2 <9.6> ^①	2.09	0.75	HG-JR73							●			● ^②									261540	
			3.2	9.6 <12.7> ^①	2.65	1.0	HG-JR103								●		● ^②									261541	
			4.8	14.3 <19.1> ^①	3.79	1.5	HG-JR153									●		● ^②									261542
			6.4	19.1 <25.5> ^①	4.92	2.0	HG-JR203										●		● ^②								261543
	1500	3000	10.5	32.0 <44.6> ^①	13.2	3.3 <3.5> ^③	HG-JR353										●		● ^②								261544
			15.9	47.7 <63.7> ^①	19.0	5.0	HG-JR503											●		● ^②						261545	
			22.3	66.8	43.3	7.0	HG-JR703													●							261546
			28.6	85.8	55.8	9.0	HG-JR903															●					261547
			70.0	210	220	11	HG-JR11K1M																●				261557
2500	3000	95.5	286	315	15	HG-JR15K1M														●				261558			
		140	420	489	22	HG-JR22K1M															●		261559				
																								261599			
HG-RR R	3000	4500	3.2	8.0	1.50	1.0	HG-RR103	200 V AC	IP65								●								262896		
			4.8	11.9	1.90	1.5	HG-RR153												●							262897	
			6.4	15.9	2.30	2.0	HG-RR203													●						262898	
			11.1	27.9	8.30	3.5	HG-RR353														●					262899	
			15.9	39.8	12.0	5.0	HG-RR503															●					262900

① The value in angle brackets is applicable when the maximum torque is increased. The maximum torque will be increased by changing the servo amplifier to be combined (see ②).

② This combination of the HG-JR servo motor and the servo amplifier increases the maximum torque from 300 % to 400 % of the rated torque.

③ The value in angle brackets is applicable when the servo motor is used with MR-J4-500B or MR-J4-500A.

④ 22 kW of HG-JR series is rated IP44

Motors for MR-J4 series servo amplifiers (400 V)

Motor series 400 V	Rated speed [r/min]	Max. speed [r/min]	Rated torque [Nm]	Max. torque [Nm]	Moment of inertia J [x10 ⁻⁴ kg m ²]	Rated output capacity [kW]	Servo motor model	Servo motor type		Amplifier pairing MR-J4									Art. no.			
								Voltage	Protective structure	60	100	200	350	500	700	11K	15K	22K				
HG-SR S	2000	3000	2.4	7.2	7.26	0.5	HG-SR524	400 V AC	IP67	●										261431		
			4.8	14.3	11.6	1.0	HG-SR1024				●									261432		
			7.2	21.5	16.0	1.5	HG-SR1524					●									261433	
			9.5	28.6	46.8	2.0	HG-SR2024						●									261434
			16.7	50.1	78.6	3.5	HG-SR3524							●								261435
			23.9	71.6	99.7	5.0	HG-SR5024								●							261436
			33.4	100	151	7.0	HG-SR7024									●						261437
HG-JR J	3000	6000	1.6	4.8 <6.4> ^①	1.52	0.5	HG-JR534	400 V AC	IP67 ^④	●	● ^②									261445		
			2.4	7.2 <9.6> ^①	2.09	0.75	HG-JR734				●	● ^②									261446	
			3.2	9.6 <12.7> ^①	2.65	1.0	HG-JR1034				●	● ^②									261447	
			4.8	14.3 <19.1> ^①	3.79	1.5	HG-JR1534					●	● ^②									261448
			6.4	19.1 <25.5> ^①	4.92	2.0	HG-JR2034					●	● ^②									261449
			10.5 <11.1> ^③	32.0 <44.6> ^①	13.2	3.3 <3.5> ^③	HG-JR3534						●	● ^{②③}								261450
			15.9	47.7 <63.7> ^①	19.0	5.0	HG-JR5034							●	● ^②							261451
		5000	22.3	66.8	43.3	7.0	HG-JR7034								●							261452
			28.6	85.8	55.8	9.0	HG-JR9034									●						261453
			70.0	210	220	11	HG-JR11K1M4										●					261384
		1500	3000	95.5	286	315	15			HG-JR15K1M4								●				261535
				2500	140	420	489			22	HG-JR22K1M4									●		261536

① The value in angle brackets is applicable when the maximum torque is increased. The maximum torque will be increased by changing the servo amplifier to be combined (see ②).

② This combination of the HG-JR servo motor and the servo amplifier increases the maximum torque from 300 % to 400 % of the rated torque.

③ The value in angle brackets is applicable when the servo motor is used with MR-J4-500B or MR-J4-500A.

④ 22 kW of HG-JR series is rated IP44

Motors for MR-ES series servo amplifiers

Motor series	Rated speed [r/min]	Max. speed [r/min]	Rated torque [Nm]	Max. torque [Nm]	Moment of inertia J [x10 ⁻⁴ kg m ²]	Rated output capacity [kW]	Servo motor model	Servo motor type		Amplifier pairing MR-E						Art. no.		
								Voltage	Protective structure	10A 10AG	20A 20AG	40A 40AG	70A 70AG	100A 100AG	200A 200AG			
HF-KN K	3000	4500	0.32	0.95	0.088	0.1	HF-KN13	200 V AC	IP65	●								239797
			0.64	1.9	0.24	0.2	HF-KN23K				●							253946
			1.3	3.8	0.42	0.4	HF-KN43K					●						253947
			2.4	7.2	1.43	0.75	HF-KN73JK						●					253948
HF-SN S	2000	3000	2.39	7.16	6.1	0.5	HF-SN52JK	200 V AC	IP67				●					253952
			4.77	14.3	11.9	1.0	HF-SN102JK							●			253953	
			7.16	21.5	17.8	1.5	HF-SN152JK								●		253954	
			9.55	28.6	38.3	2.0	HF-SN202JK									●	253965	

Dimensions of motors for MR-J4 series servo amplifiers

HG-KR13 (B), HG-KR053 (B), HG-MR13 (B), HG-MR053 (B)

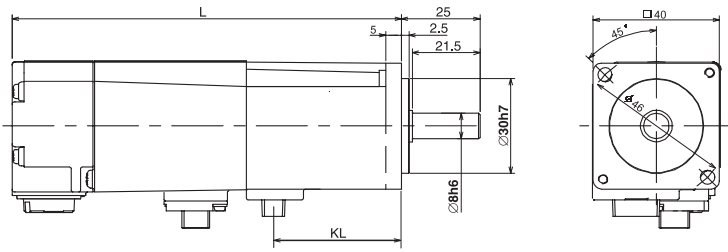

Type	L [mm]	KL [mm]
HG-KR13 (B) HG-MR13 (B)	66.4 (107)	23.8
HG-KR053 (B) HG-MR053 (B)	82.4 (123)	39.8

Dimensions for motors with brake in brackets ().

Unit: mm

HG-KR23 (B), HG-KR43 (B), HG-MR23 (B), HG-MR43 (B)

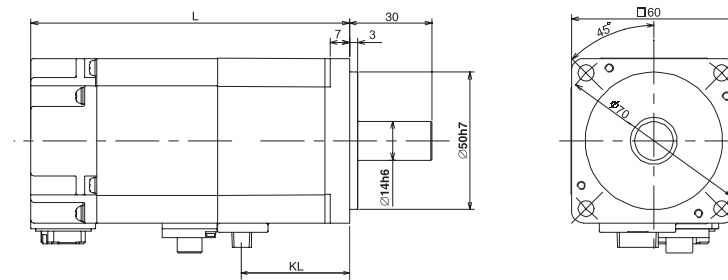

Type	L [mm]	KL [mm]
HG-KR23 (B) HG-MR23 (B)	76.6 (113.4)	36.4
HG-KR43 (B) HG-MR43 (B)	98.3 (135.1)	58.1

Dimensions for motors with brake in brackets ().

Unit: mm

HG-KR73 (B), HG-MR73 (B)

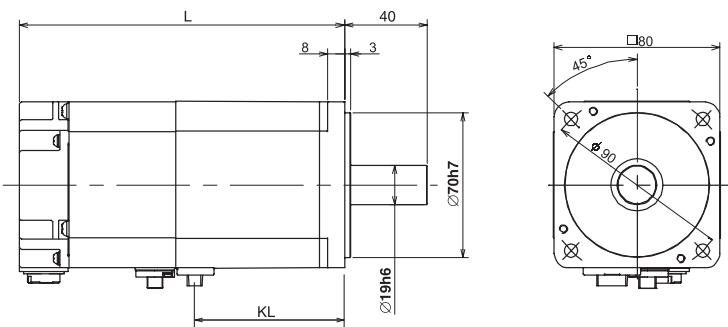

Type	L [mm]	KL [mm]
HG-KR73 (B) HG-MR73 (B)	112 (152.3)	69.6

Dimensions for motors with brake in brackets ().

Unit: mm

HG-SR52 (B), HG-SR524 (B), HG-SR102 (B), HG-SR1024 (B), HG-SR152 (B), HG-SR1524 (B)

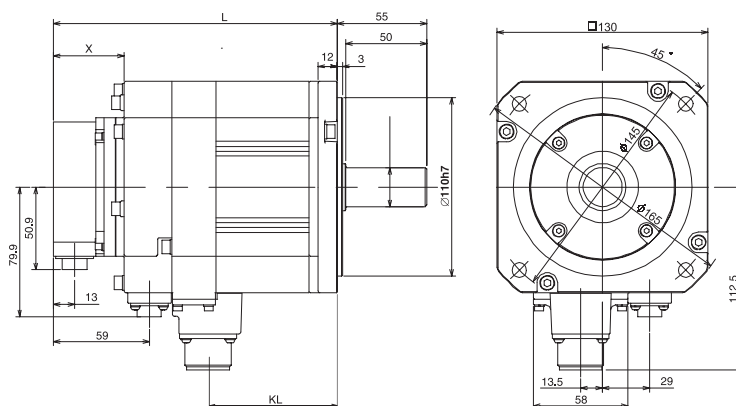

Type	L [mm]	KL [mm]	X [mm]
HG-SR52 (B) HG-SR524 (B)	118.5 (153.0)	57.8	38.2 (43.5)
HG-SR102 (B) HG-SR1024 (B)	132.5 (167)	71.8	38.2 (43.5)
HG-SR152 (B) HG-SR1524 (B)	146.5 (181)	85.8	38.2 (43.5)

Dimensions for motors with brake in brackets ().

Unit: mm

HG-SR202 (B), HG-SR352 (B), HG-SR502 (B), HG-SR702 (B), HG-SR2024 (B), HG-SR3524 (B), HG-SR5024 (B), HG-SR7024 (B),

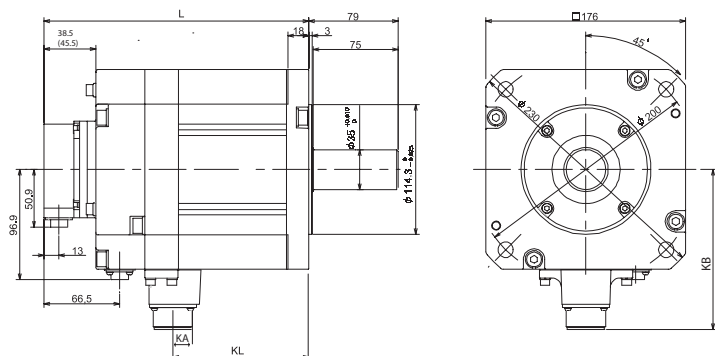

Type	L [mm]	KL [mm]	KA [mm]	KB [mm]
HG-SR202 (B) HG-SR2024 (B)	138.5 (188)	74.8		
HG-SR352 (B) HG-SR3524 (B)	162.5 (212)	98.8	24.8	140.9
HG-SR502 (B) HG-SR5024 (B)	178.5 (228)	114.8		
HG-SR702 (B) HG-SR7024 (B)	218.5 (268)	146.8	32	149.1

Dimensions for motors with brake in brackets ().

Unit: mm

HG-JR53 (B), HG-JR534 (B), HG-JR73 (B), HG-JR734 (B), HG-JR103 (B), HG-JR1034 (B), HG-JR153 (B), HG-JR1534 (B), HG-JR203 (B), HG-JR2034 (B)

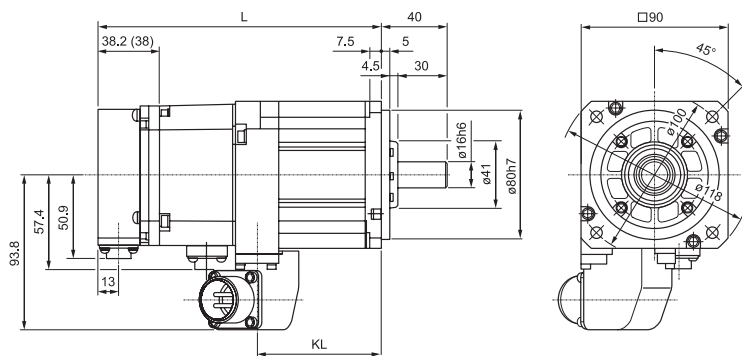

Type	L [mm]	KL [mm]
HG-JR53 (B) HG-JR534 (B)	127.5 (173)	76
HG-JR73 (B) HG-JR734 (B)	145.5 (191)	94
HG-JR103 (B) HG-JR1034 (B)	163.5 (209)	112
HG-JR1534 (B) HG-JR1534 (B)	199.5 (245)	148
HG-JR203 (B) HG-JR2034 (B)	235.5 (281)	184

Dimensions for motors with brake in brackets ().

Unit: mm

HG-JR353(B), HG-JR503(B)

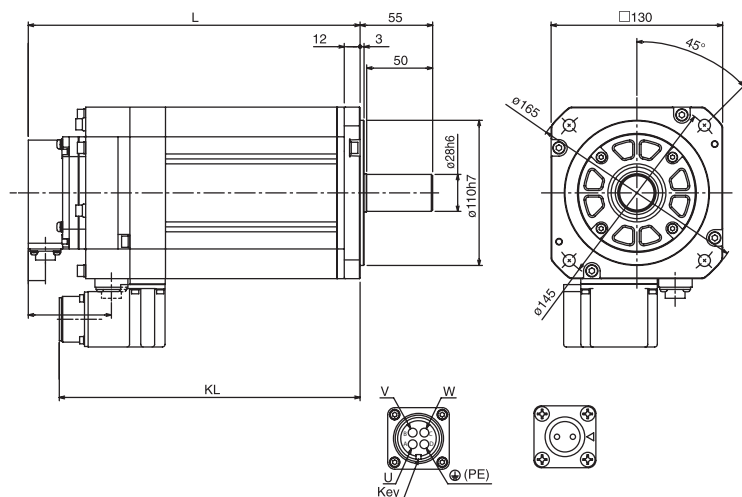

Type	L [mm]	KL [mm]
HG-JR353(B)	213 (251.5)	228
HG-JR5034(B)	267 (305.5)	282

Dimensions for motors with brake in brackets ().

Unit: mm

HG-JR3534(B), HG-JR5034(B)

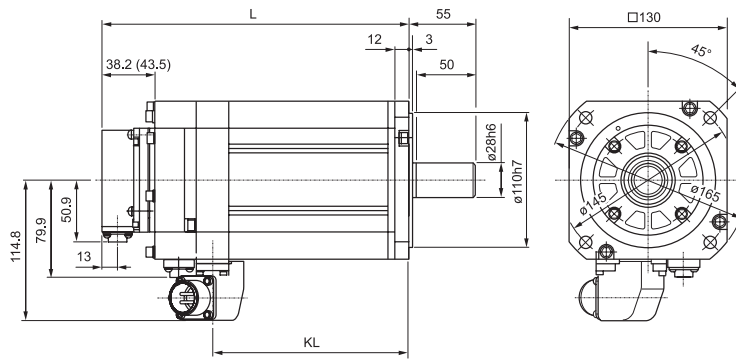

Type	L [mm]	KL [mm]
HG-JR3534(B)	213 (251.5)	161
HG-JR5034(B)	267 (305.5)	215

Dimensions for motors with brake in brackets ().

Unit: mm

HG-JR703(B), HG-JR903(B), HG-JR7034(B), HG-JR9034(B)

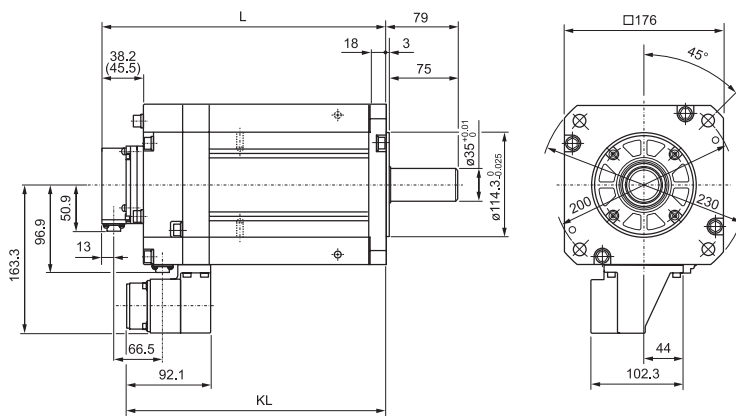

Type	L [mm]	KL [mm]
HG-JR703(B)	263.5 (313)	285.4
HG-JR7034(B)		
HG-JR903(B)	303.5 (353)	325.4
HG-JR9034(B)		

Dimensions for motors with brake in brackets ().

Unit: mm

HG-JR11K1M(B), HG-JR15K1M(B), HG-JR11K1M4(B), HG-JR15K1M4(B)

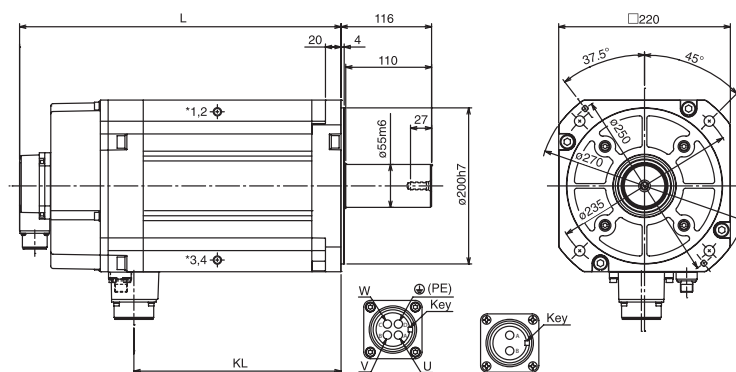

Type	L [mm]	KL [mm]
HG-JR11K1M(B)	339.5 (412)	265.5
HG-JR11K1M4(B)		
HG-JR15K1M(B)	439.5 (512)	365.5
HG-JR15K1M4(B)		

Dimensions for motors with brake in brackets ().

Unit: mm

HG-JR22K1M, HG-JR22K1M4

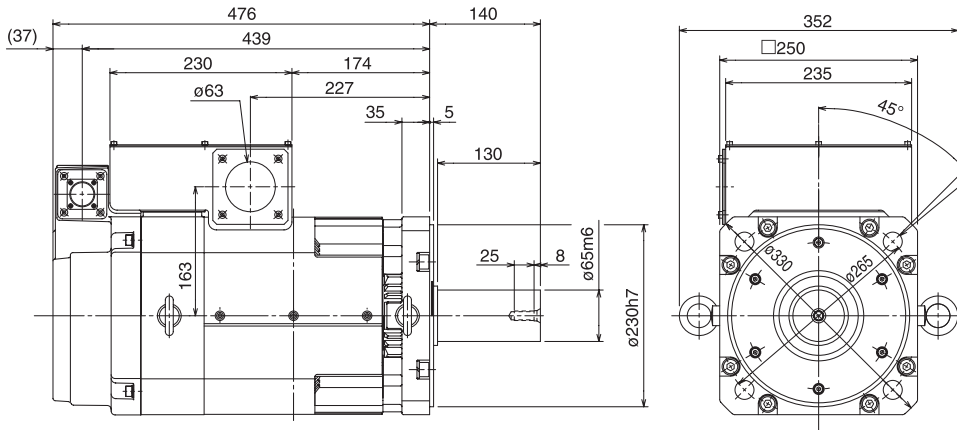

HG-RR103(B), HG-RR153(B), HG-RR203(B)

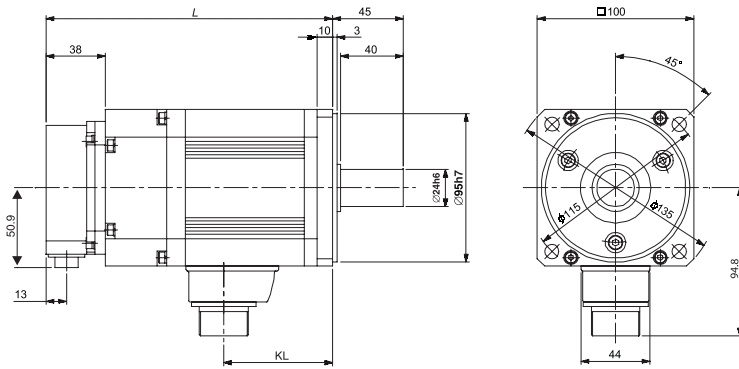

Type	L [mm]	KL [mm]
HG-RR103(B)	145.5 (183)	69.5
HG-RR153(B)	170.5 (208)	94.5
HG-RR203(B)	195.5 (233)	119.5

Dimensions for motors with brake in brackets ().

Unit: mm

HG-RR353(B), HG-RR503(B)

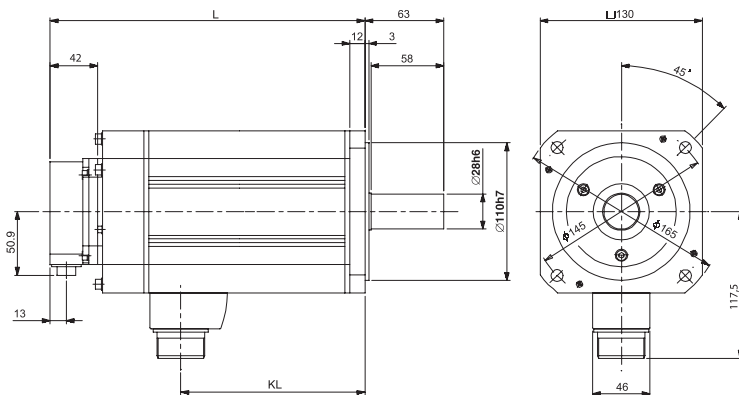

Type	L [mm]	KL [mm]
HG-RR353(B)	215.5 (252)	147.5
HG-RR503(B)	272.5 (309)	204.5

Dimensions for motors with brake in brackets ().

Unit: mm

Dimensions of motors for MR-ES series servo amplifiers

HF-KN13(B)

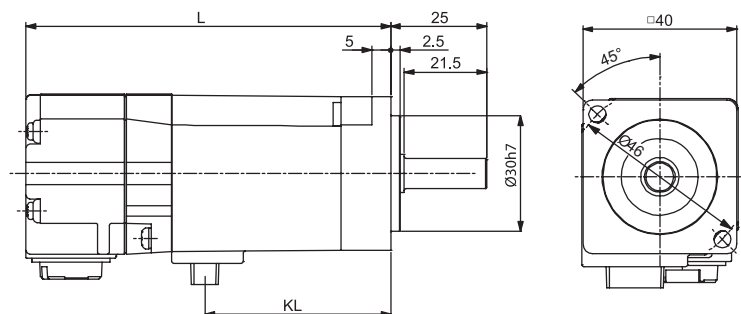

Type	L [mm]	KL [mm]
HF-KN13(B)	87 (123.9)	40.4

Dimensions for motors with brake in brackets ().

Unit: mm

HF-KN23(B)K

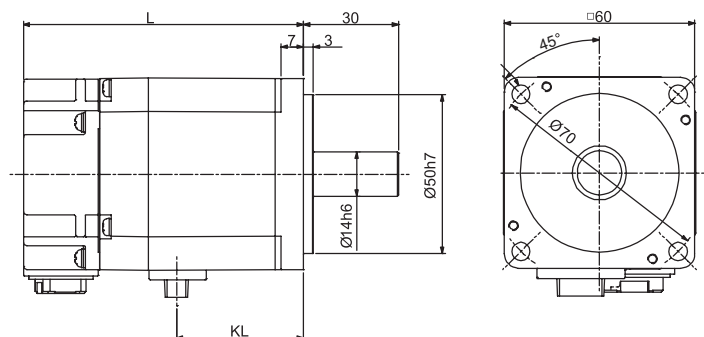

Type	L [mm]	KL [mm]
HF-KN23(B)K ^①	88.2 (116.8)	40

Dimensions for motors with brake in brackets ().

^① Motor with keyway shaft. (A key is supplied with the motor).

Unit: mm

HF-KN43(B)K

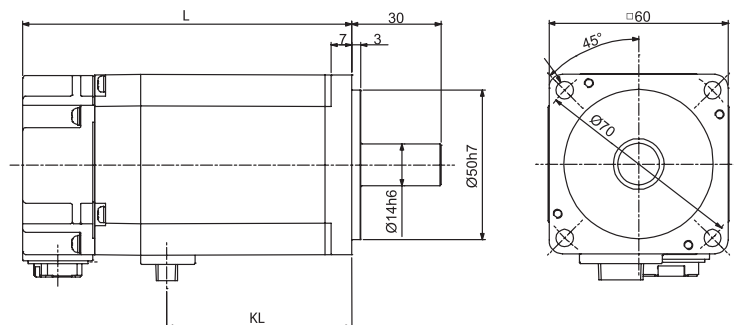

Type	L [mm]	KL [mm]
HF-KN43(B)K ^①	110.2 (138.8)	62

Dimensions for motors with brake in brackets ().

^① Motor with keyway shaft. (A key is supplied with the motor).

Unit: mm

HF-KN73(B)JK

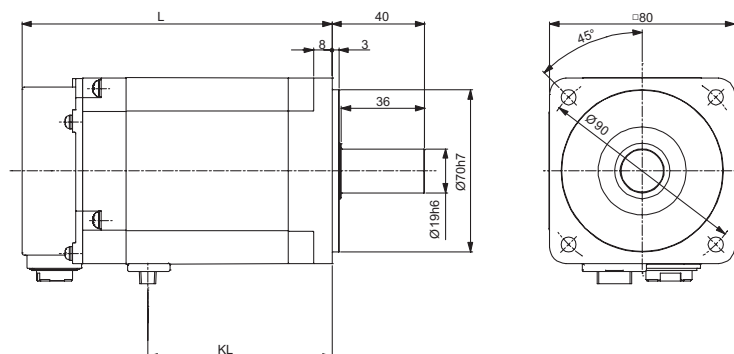

Type	L [mm]	KL [mm]
HF-KN73(B)JK ^①	133.9 (166.5)	79.6

Dimensions for motors with brake in brackets ().

^① Motor with keyway shaft. (A key is supplied with the motor).

Unit: mm

HF-SN52(B)JK

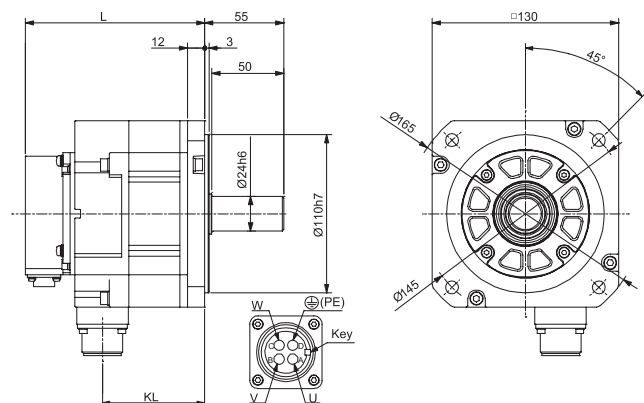

Type	L [mm]	KL [mm]
HF-SN52(B)JK ①	125 (163)	71.3

Dimensions for motors with brake in brackets ().
 ① Motor with keyway shaft. (A key is NOT supplied with the motor).

Unit: mm

HF-SN102(B)JK

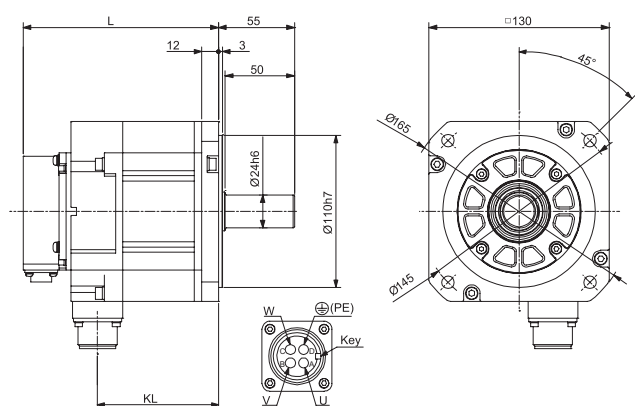

Type	L [mm]	KL [mm]
HF-SN102(B)JK ①	141 (179)	87.3

Dimensions for motors with brake in brackets ().
 ① Motor with keyway shaft. (A key is NOT supplied with the motor).

Unit: mm

HF-SN152(B)JK

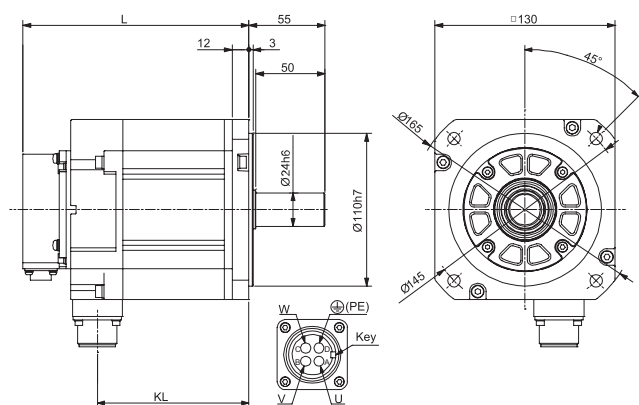

Type	L [mm]	KL [mm]
HF-SN152(B)JK ①	163 (201)	109.3

Dimensions for motors with brake in brackets ().
 ① Motor with keyway shaft. (A key is NOT supplied with the motor).

Unit: mm

HF-SN202(B)JK

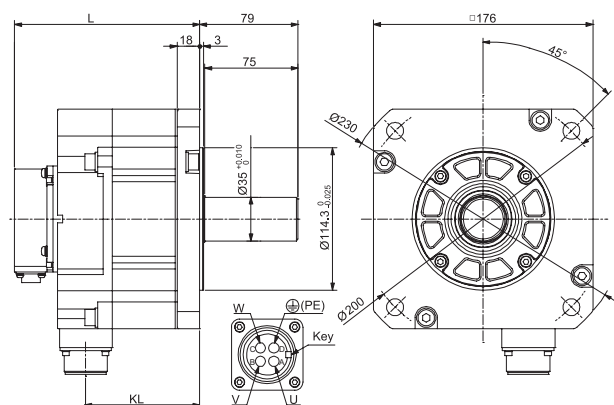

Type	L [mm]	KL [mm]
HF-SN202(B)JK ①	148.5 (200.5)	91.5

Dimensions for motors with brake in brackets ().
 ① Motor with keyway shaft. (A key is NOT supplied with the motor).

Unit: mm

MR-ES servo amplifier specifications

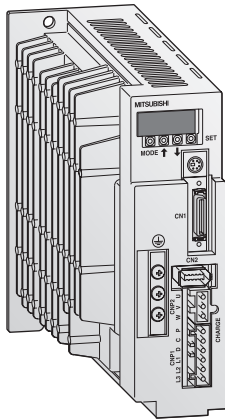

The servo amplifier of the series

ME-E Super combines unique functions with very compact dimensions. With its high positioning accuracy and high responsiveness the MR-E Super is suitable for applications from 100 W to 2 kW. Available functions of the drive are e.g. position/internal speed control mode, speed/torque control mode and Mitsubishi Electric's well known real-time auto-tuning. The compact size helps designers, to fit all control components needed for an automation system into the smallest space.

For a fast, easy and secure wiring all connectors are located on the front of the servo amplifier. The powerful software package SETUP154E makes set up and diagnostics of the system quick and comfortable.

Servo amplifier MR-E-A/AG ^①	10A 10AG 0.1 kW	20A 20AG 0.2 kW	40A 40AG 0.4 kW	70A 70AG 0.75 kW	100A 100AG 1 kW	200A 200AG 2 kW	
Power supply	3-phase 200–230 V AC, 50/60 Hz; 1phase 200–230 V AC, 50/60 Hz				3-phase 200–230 V AC, 50/60 Hz		
Control system	Sinusoidal PWM control/current control system						
Dynamic brake	Built-in						
Protective functions	Overcurrent shutdown, regeneration overvoltage shutdown, overload shutdown (electronic thermal), encoder fault protection, regeneration fault protection, undervoltage/sudden power outage protection, overspeed protection, excess error protection						
Structure/protection	Self-cooling, open (IP00); 200A/AG fan-cooling, open (IP00)						
Environment	ambient temperature						
	Operation: 0–55 °C (no freezing); Storage: -20–65 °C (no freezing)						
	ambient humidity						
		Operation: 90 % RH max. (no condensation); Storage: 90 % RH max. (no condensation)					
		Elevation: 1000 m or less above sea level; Oscillation: 5.9 m/s ² (0.6 G) max.					
Weight	kg	0.7	0.7	1.1	1.7	1.7	2.0
Dimensions (WxHxD)	mm	50x168x135	50x168x135	70x168x135	70x168x190	70x168x190	70x168x195
Order information							
A type	Art. no.	213069	213070	213071	213072	213073	213074
AG type	Art. no.	213075	213076	213077	213078	213079	213080

① Type A: pulse train interface, type AG: analog input interface

Servo amplifier		MR-E-A	MR-E-AG
Position control mode	max. input pulse frequency	1 Mpps (differential receiver), 200 kpps (open collector)	—
	positioning feedback pulse	131072 pulses per servo motor rotation	—
	torque limit	Set by parameters	—
Speed control mode	control range	Internal speed command 1:5000	Analog speed command 1:2000, internal speed command 1:5000
	fluctuation rate	±0.01 % max. (load fluctuation 0–100 %)	±0.01 % max. (load fluctuation 0–100 %)
	torque limit	Set by parameters	Set by parameters or external analog input (0–±10 V DC/max. torque)
Torque control mode	command input	—	0–±8 V DC/max. torque
	speed limit	—	Set by parameters or external analog input (0–±10 V DC/rated speed)

MR-J4 servo amplifier specifications (200 V type)

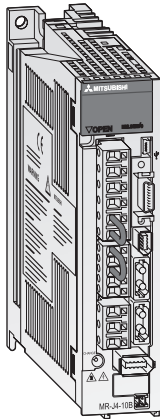

The MELSERVO MR-J4 series is designed for ease of use and setup, safety, energy-efficiency and user friendly handling. With additional functions like “One-touch Tuning” and “Advanced Vibration Suppression Control” the servo performance achieves industry-leading level. The range covers 100 W units through to 22 kW.

- Processing of encoder signals with 22 bit resolution (4.194.304 pulses/rev.)
- Speed frequency response is increased to 2.5 kHz
- Operating of rotary, linear and direct drive motors as standard
- Compatible with safety functions STO (Safe Torque Off) and SS1 (Safe Stop 1) corresponding EN 61800-5-2 as standard.

The MR-J4-B servo amplifier receives a command signal from a control system via high speed motion network SSCNETIII/H with a communication speed of 150 Mbps and a cycle time of 0.22 ms. This optical network is very reliable in operation because it is not affected by EMC.

For control, the MR-J4-A servo amplifier has a pulse train input and two analog inputs for current or voltage. Possible modes of the MR-J4-A are torque, speed or position control.

Common specifications MR-J4-A/B		10A 10B	20A 20B	40A 40B	60A 60B	70A 70B	100A 100B	200A 200B	350A 350B	500A 500B	700A 700B	11KA 11KB	15KA 15KB	22KA 22KB	
Power supply	voltage /frequency ^①	1-phase or 3-phase 200–240 V AC, 50/60 Hz					3-phase 200–240 V AC, 50/60 Hz								
	permissible voltage fluctuation	1-phase or 3-phase 170–264 V AC					3-phase 170–264 V AC								
	permissible frequency fluctuation	± 5 % max.													
Control system	Sinusoidal PWM control/current control system														
Dynamic brake	Built-in											External option			
Speed frequency response	2500 Hz														
Protective functions	Overcurrent shutdown, regeneration overvoltage shutdown, overload shutdown (electronic thermal), servomotor overheat protection, encoder fault protection, regeneration fault protection, undervoltage/sudden power outage protection, overspeed protection, excess error protection.														
Safety function	STO (IEC/EN 61800-5-2); (SS1 function is available by using the safety option card MR-J3-D05)														
Structure	Self-cooling, open (IP20)							Fan cooling, open (IP20)							
Environment	ambient temperature	Operation: 0–55 °C (no freezing), storage: -20–65 °C (no freezing)													
	ambient humidity	Operation: 90 % RH max. (no condensation), storage: 90 % RH max. (no condensation)													
	atmosphere	Inside control panel; no corrosive gas, no flammable gas, no oil mist, no dust													
	elevation	1000 m or less above sea level													
	oscillation	5.9 m/s ² (0.6 G) max.													
Weight	kg	0.8	0.8	1.0	1.0	1.4	1.4	2.1	2.3	4.0	6.2	13.4	13.4	18.2	
Dimensions (WxHxD)	mm	40x 168x135	40x 168x135	40x 168x170	40x 168x170	60x 168x185	60x 168x185	90x 168x195	90x 168x195	105x 250x200	172x 300x200	220x 400x260	220x 400x260	260x 400x260	
Order information															
A type	Art. no.	248600	248601	248602	248628	248629	248630	248631	248632	248633	248634	261419	261420	261421	
B type	Art. no.	248635	248636	248637	248638	248639	248640	248641	248642	248643	248644	261422	261423	261424	

① Rated output capacity and rated rotation speed of the servo motor used in combination with the servo amplifier are as indicated when using the power voltage and frequency listed. Output and speed cannot be guaranteed when the power supply voltage is less than specified.

Control specifications MR-J4-A		10A	20A	40A	60A	70A	100A	200A	350A	500A	700A	11KA	15KA	22KA	
Position control mode	maximum input pulse frequency	4 Mpps (when using differential receiver), 200 kpps (when using open collector)													
	positioning feedback pulse	Resolution per encoder/servo motor rotation: 4194304 pulses/revolution (22 Bit)													
	command pulse multiple	Electronic gear A/B multiple; A: 1–16777216, B: 1–16777216, 1/10 <A/B <4000													
	positioning complete width setting	0–±65535 pulses (command pulse unit)													
Speed control mode	excess error	±3 rotations													
	torque limit input	Set by parameters or external analog input (0–± 10 V DC/maximum torque)													
	speed control range	Analog speed command 1:2000, internal speed command 1:5000													
	analog speed command input	0–± 10 V DC/rated speed (The speed at 10 V can be changed by parameter)													
Torque control specifications	speed fluctuation rate	±0.01 % max. (load fluctuation 0–100 %); 0 % (power fluctuation ±10 %) ±0.2 % max. (ambient temperature 25 °C ±10 °C), when using external analog speed command													
	torque limit	Set by parameters or external analog input (0–± 10 V DC/maximum torque)													
Torque control specifications	torque command input	0–±8 V DC/maximum torque (input impedance 10–12 kΩ)													
	speed limit	Set by parameters or external analog input (0–± 10 V DC, rated speed)													

Control specifications MR-J4-B (SSCNETIII/H)		10B	20B	40B	60B	70B	100B	200B	350B	500B	700B	11KB	15KB	22KB
Position and speed control	Possible using SSCNETIII/H control													
Communication speed	150 Mbps													

MR-J4 servo amplifier specifications (400 V type)

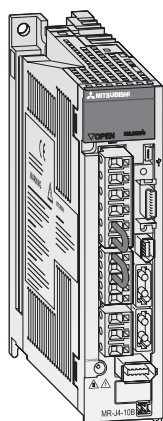

The MELSERVO MR-J4 servo amplifiers for 400 V power supply offer the same industry leading performance as the 200 V types. The range of rated output is from 600 W to 22 kW.

Common specifications MR-J4-A4/B4		60A4 60B4	100A4 100B4	200A4 200B4	350A4 350B4	500A4 500B4	700A4 700B4	11KA4 11KB4	15KA4 15KB4	22KA4 22KB4	
Power supply	voltage /frequency ^①	3-phase 380–480 V AC, 50/60 Hz									
	permissible voltage fluctuation	3-phase 323–528 V AC, 50/60 Hz									
	permissible frequency fluctuation	±5 % max.									
Control system		Sinusoidal PWM control/current control system									
Dynamic brake		Built-in									
Speed frequency response		2500 Hz									
Protective functions		Overcurrent shutdown, regeneration overvoltage shutdown, overload shutdown (electronic thermal), servomotor overheat protection, encoder fault protection, regeneration fault protection, undervoltage/sudden power outage protection, overspeed protection, excess error protection.									
Safety function		STO (IEC/EN 61800-5-2) ; (SS1 function is available by using the safety option card MR-J3-D05)									
Structure		Self-cooling, open (IP20)					Fan cooling, open (IP20)				
Environment	ambient temperature	Operation: 0–55 °C (no freezing), storage: -20–65 °C (no freezing)									
	ambient humidity	Operation: 90 % RH max. (no condensation), storage: 90 % RH max. (no condensation)									
	atmosphere	Inside control panel; no corrosive gas, no flammable gas, no oil mist, no dust									
	elevation	1000 m or less above sea level									
	oscillation	5.9 m/s ² (0.6 G) max.									
Weight	kg	1.7	1.7	2.1	3.6	4.3	6.5	13.4	13.4	18.2	
Dimensions (WxHxD)	mm	90x168x195	90x168x195	90x168x195	130x250x200	130x250x200	180x350x200	260x400x260	260x400x260	260x400x260	
Order information											
A type	Art. no.	261367	261368	261369	261370	261371	261372	261425	261426	261427	
B type	Art. no.	261373	261374	261415	261416	261417	261418	261428	261429	261430	

① Rated output capacity and rated rotation speed of the servo motor used in combination with the servo amplifier are as indicated when using the power voltage and frequency listed. Output and speed cannot be guaranteed when the power supply voltage is less than specified.

Control specifications MR-J4-A4		60A	100A	200A	350A	500A	700A	11KA	15KA	22KA	
Position control mode	maximum input pulse frequency	4 Mpps (when using differential receiver), 200 kpps (when using open collector)									
	positioning feedback pulse	Resolution per encoder/servo motor rotation: 4194304 pulses/revolution (22 Bit)									
	command pulse multiple	Electronic gear A/B multiple; A: 1–16777216, B: 1–16777216, 1/10 <A/B <4000									
	positioning complete width setting	0–±65535 pulses (command pulse unit)									
	excess error	±3 rotations									
Speed control mode	torque limit input	Set by parameters or external analog input (0–±10 V DC/maximum torque)									
	speed control range	Analog speed command 1:2000, internal speed command 1:5000									
	analog speed command input	0–±10 V DC/rated speed (The speed at 10 V can be changed by parameter.)									
	speed fluctuation rate	±0.01 % max. (load fluctuation 0–100 %); 0 % (power fluctuation ±10 %) ±0.2 % max. (ambient temperature 25 °C ±10 °C), when using external analog speed command									
Torque control specifications	torque limit	Set by parameters or external analog input (0–±10 V DC/maximum torque)									
	torque command input	0–±8 V DC/maximum torque (input impedance 10–12 kΩ)									
	speed limit	Set by parameters or external analog input (0–±10 V DC, rated speed)									

Control specifications MR-J4-B4 (SSCNETIII/H)		60B	100B	200B	350B	500B	700B	11KB	15KB	22KB	
Position and speed control		Possible using SSCNETIII/H control									
Communication speed		150 Mbps									

MR-J4W2-B/MR-J4W3-B servo amplifier specifications

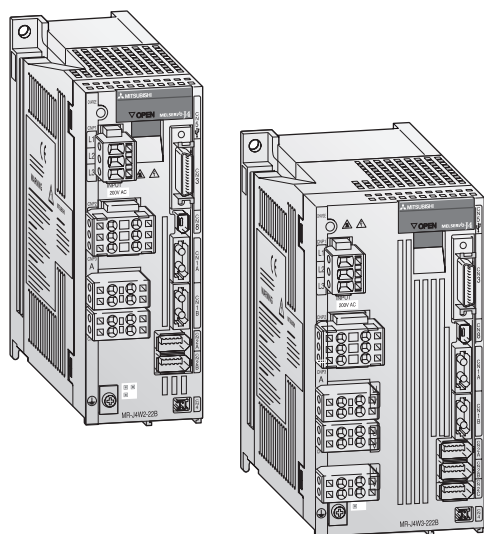

Additional to the standard version of the MR-J4 amplifiers (SSCNETIII/H Motion Network) for one servo motor Mitsubishi Electric now offers also servo amplifiers for two or three servo motors. The amplifiers for two (MR-J4W2-B) and three axes (MR-J4W3-B) are space and wiring saving and more efficient than two or three single amplifiers. Therefore the engineer saves not only space inside the cabinet and costs due to less wires, but also valuable energy what reduces the pollution of CO₂ at the same time. The range of output power

for the amplifier for two axes is from 0.2 to 1 kW, for three axes from 0.2 to 0.4 kW per axis. All other specification items are identical with the standard version of the MR-J4-B for one axis.

Common specifications MR-J4W-B		W2-22B	W2-44B	W2-77B	W2-1010B	W3-222B	W3-444B	
Power supply	voltage /frequency ^①	1-phase or 3-phase 200–240 V AC, 50/60 Hz			3-phase 200–240 V AC, 50/60 Hz	1-phase or 3-phase 200–240 V AC, 50/60 Hz		
	permissible voltage fluctuation	1-phase or 3-phase 170–264 V AC			3-phase 170–264 V AC	1-phase or 3-phase 170–264 V AC		
	permissible frequency fluctuation	±5 % max.						
Control system		Sinusoidal PWM control/current control system						
Dynamic brake		Built-in						
Speed frequency response		2500 Hz						
Protective functions		Overcurrent shutdown, regeneration overvoltage shutdown, overload shutdown (electronic thermal), servomotor overheat protection, encoder fault protection, regeneration fault protection, undervoltage/sudden power outage protection, overspeed protection, excess error protection.						
Safety function		STO (IEC/EN 61800-5-2); (SS1 function is available by using the safety option card MR-J3-D05)						
Structure		Self-cooling, open (IP20) Fan cooling, open (IP20)						
Environment	ambient temperature	Operation: 0–55 °C (no freezing), storage: -20–65 °C (no freezing)						
	atmosphere	Inside control panel; no corrosive gas, no flammable gas, no oil mist, no dust						
	elevation	1000 m or less above sea level						
	oscillation	5.9 m/s ² (0.6 G) max.						
Weight	kg	1.5	1.5	2.0	2.0	1.9	1.9	
Dimensions (WxHxD)	mm	60x168x195	60x168x195	85x168x195	85x168x195	85x168x195	85x168x195	
Order information		Art. no.	248645	248646	248647	248648	248649	248650

① Rated output capacity and rated rotation speed of the servo motor used in combination with the servo amplifier are as indicated when using the power voltage and frequency listed. Output and speed cannot be guaranteed when the power supply voltage is less than specified.

MR-J3-D05 Safety logic unit

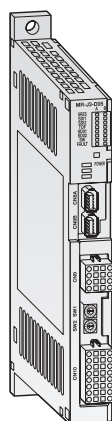

The function of the safety option card MR-J3-D05 can be compared with a programmable safety relay. In combination with MR-J3-BSafety and MR-J4-A/B additional safety functions according EN 61800-5-2 and additional Emergency Stop functions according EN IEC 60204-1 are available. Among "Safe Torque Off" (STO) also "Safe Stop" (SS1) is possible.

With SS1 the connected motor will be stopped "by control" in a fixed time. When the minimum speed is reached, the safety

function STO will be activated preventing the re-start of the motor by disconnecting the motor power supply. Emergency Stop functions like EMG OFF (Emergency Off) and EMG STOP (Emergency Stop) according EN IEC 60204-1 can be realised with an appropriate wiring. One unit of MR-J3-D05 supports save operation of 2 axes.

Common specifications MR-J3-BSafety		MR-J3-D05
Control power supply	voltage /frequency	24 V DC
	permissible voltage fluctuation	24 V DC 10 %
	power supply capacity	500 mA ^① ^②
Connectable axes		2 axes, independently controlled
Extendible safety standards		Cat. 3 (EN 954-1), SIL2 (IEC 61508), SILCL2 (EN 62061), PL d (EN ISO 13849-1), STO/SS1 (EN 61800-5-2) cat. 0/1 (EN 60204-1), MTTFd 100 years, DC 90 %, PFH 1.01E-07 1/h
Shut-off input (Safety devices)		4 points (2 points x 2 axes), source/sink logic compatible
Shut-off release input (restart devices)		2 points (1 points x 2 axes), source/sink logic compatible
Response time		20 ms or less for Safe Torque Off (STO)
Delay time setting		0 s, 1.4 s, 2.8 s, 9.8 s, 30.8 s, 2 % (additional for axis A: 5.6 s)
Environment	ambient temperature	Operation: 0–55 °C (no freezing), storage: -20–65 °C (no freezing)
	ambient humidity	Operation: 90 % RH or less (no condensation), storage: 90 % RH or less (no condensation)
	atmosphere	Inside control panel; no corrosive gas, no flammable gas, no oil mist, no dust
	elevation	1000 m or less above sea level
	oscillation	5.9 m/s ² or less at 10–55 Hz (directions of X, Y and Z axes)
Weight	kg	0.15
Dimensions (WxHxD)	mm	22.5x192x86
Order information	Art. no.	227486

① Inrush current of approximately 1.5 mA flow instantaneously when turning the control power supply on. Select an appropriate power supply considering the inrush current.

② Number of turning the power on is 100000.

Positioning modules MELSEC System Q

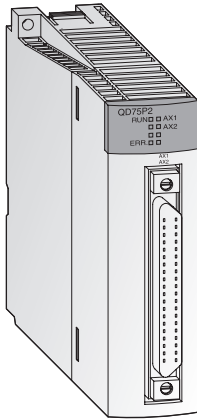

The MELSEC System Q offers three different positioning module series for control of up to four axes

- Open-collector output type (QD75P series)
- Differential output type (QD75D series)
- SSCNETIII bus type (QD75MH series)

The open-collector and differential output controllers can be used with standard type servo amplifiers (MR-ES-A/MR-J4-A), whilst the QD75MH series controllers should be used with the MR-J4-B (SSCNETIII bus type) servo amplifiers. Using the SSCNETIII system can provide much improved, easier to use positioning system, with reduced wiring and better noise immunity.

All QD75 series positioning modules can provide functionality such as interpolation and speed-position operation etc.

The open-collector output type modules provide positioning with open loop control. The modules generate the travel command via the pulse chain. The speed is proportional to the pulse frequency and the distance travelled is proportional to the pulse length.

The differential output type modules are suitable for bridging long distances between the module and the drive system due to the fact that the output allows large motor cable lengths.

Specifications	QD75D1	QD75D2	QD75D4	QD75P1	QD75P2	QD75P4
Number of control axes	1	2	4	1	2	4
Interpolation	—	2 axes linear and circular interpolation	2, 3, or 4 axes linear and 2 axes circular interpolation	—	2 axes linear and circular interpolation	2, 3, or 4 axes linear and 2 axes circular interpolation
Positioning data items	600					
Output type	Differential driver	Differential driver	Differential driver	Open collector	Open collector	Open collector
Output signal	Pulse chain	Pulse chain	Pulse chain	Pulse chain	Pulse chain	Pulse chain
Positioning	PTP control: absolute data and/or incremental; speed/position switching control: incremental; locus/speed control: incremental; path control: absolute data and/or incremental					
	Absolute data:		Incremental method:		Speed/position switching control:	
	-2 147 483 648	-2 147 483 647	pulse	-2 147 483 648	-2 147 483 647	pulse
	-214 748 364.8	-214 748 364.7	µm	-214 748 364.8	-214 748 364.7	µm
	-21 474.83648	-21 474.83647	inch	-21 474.83648	-21 474.83647	inch
	0	-35.99999	degree	-21 474.83648	-21 474.83647	degree
speed	1	-1 000 000	pulse/s	0.01	-20 000 000.00	mm/min
	0.001	-200 000.000	degree/min	0.001	-200 000.000	inch/min
acceleration/deceleration processing	Automatic trapezoidal or S-pattern acceleration and deceleration or automatic S-pattern acceleration and deceleration					
acceleration and deceleration time	1-8388608 ms (4 patterns, each can be set)					
rapid stop deceleration time	1-8388608 ms					
I/O points	32	32	32	32	32	32
Dimensions (WxHxD)	mm	27.4x98x90	27.4x98x90	27.4x98x90	27.4x98x90	27.4x98x90
Order information	Art. no.	129675	132581	129676	132582	129677
Accessories	40-pin connector and ready to use connection cables and system terminals; Programming software: GX Configurator QP, art. no.: 132219					

Specifications	QD75MH1	QD75MH2	QD75MH4			
Number of control axes	1	2	4			
Interpolation	—	2 axes linear and circular interpolation	2, 3, or 4 axes linear and 2 axes circular interpolation			
Positioning data items	600					
Output type	SSCNETIII	SSCNETIII	SSCNETIII			
Output signal	Bus	Bus	Bus			
Positioning	PTP control: absolute data and/or incremental; speed/position switching control: incremental; locus/speed control: incremental; path control: absolute data and/or incremental					
	Absolute data:		Incremental method:			
	-2 147 483 648	-2 147 483 647	pulse	-2 147 483 648	-2 147 483 647	pulse
	-21 474.83648	-21 474.83647	µm	-21 474.83648	-21 474.83647	µm
	-21 474.83648	-21 474.83647	inch	-21 474.83648	-21 474.83647	inch
	0	-359.99999	degree	-21 474.83648	-21 474.83647	degree
speed	1	-50 000 000	pulse/s	0.01	-20 000 000.00	mm/min
	0.001	-2 000 000.000	degree/min	0.001	-2 000 000.000	inch/min
acceleration/deceleration processing	Automatic trapezoidal or S-pattern acceleration and deceleration or automatic S-pattern acceleration and deceleration					
acceleration and deceleration time	1-8388608 ms (4 patterns, each can be set)					
rapid stop deceleration time	1-8388608 ms					
I/O points		32	32			
Dimensions (WxHxD)	mm	27.4x98x90	27.4x98x90			
Order information	Art. no.	165761	165762			
Accessories	40-pin connector and ready to use connection cables and system terminals; Programming software: GX Configurator QP, art. no.: 132219					

Positioning modules

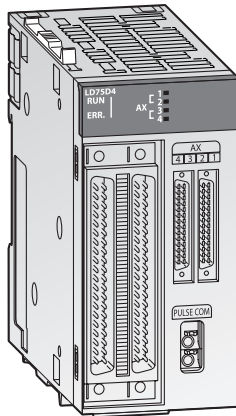

Control of high resolution drives

The MELSEC L series offers two different positioning modules for control of up to four axes.

- Differential output type (LD75D□)
- Open-collector output type (LD75P□)

These positioning modules can be used with standard type servo amplifiers (Mitsubishi Electric MR-ES-A, MR-J4-A).

All MELSEC L series positioning modules can provide functionality such as interpolation, speed positioning operation etc.

The open-collector output type module provides positioning with open loop control. The module generates the travel command via the pulse chain. The speed is proportional to the pulse frequency and the distance travelled is proportional to the pulse length.

The differential output type module is suitable for bridging long distances between the module and the drive system due to the fact that the output allows large cable lengths.

- Up to 600 positioning data per axis
- Maximum output pulse of 200 k pulses/s for LD75P4 and 4 Mpulses/s for LD75D4)
- High speed control of high resolution devices such as linear servos and direct drive motors
- Reduced machine vibration by using the optional acceleration/deceleration system
- Visualization of positioning module buffer data with customizable graphs

Specifications	LD75D1	LD75D2	LD75D4	LD75P1	LD75P2	LD75P4
Accessible axes	1	2	4	1	2	4
Output frequency	—	2-axis linear interpolation, 2-axis circular interpolation	2-/3-/4-axis linear interpolation, 2-axis circular interpolation	—	2-axis linear interpolation, 2-axis circular interpolation	2-/3-/4-axis linear interpolation, 2-axis circular interpolation
Positioning data items per axis	600					
Output type	Differential driver			Open collector		
Output signal	Pulse chain					
Positioning	method	PTP (Point To Point) control, path control (both linear and arc can be set), speed control, speed-position switching control, position-speed switching control				
	range	Absolute/incremental system: -214 748 364.8–214 748 364.7 μm -21 474.83648–21 474.83647 inch 0–359.99999 degree (absolute); 21 474.83648–21 474.83647 (incremental) -2 147 483 648–2 147 483 647 pulse In speed-position switching control (INC mode)/position-speed switching control: 0–214 748 364.7 μm 0–21 474.83647 inch 0–21 474.83647 degree 0–2 147 483 647 pulse				
	speed	1–1 000 000 pulse/s 0.01–20 000 000.00 mm/min 0.001–200 000.000 degree/min 0.001–200 000.000 inch/min				
	acceleration/deceleration processing	Automatic trapezoidal or S-pattern acceleration and deceleration or automatic S-pattern acceleration and deceleration				
	acceleration/deceleration time	1–83 88 608 ms (four patterns can be set for each of acceleration time and deceleration time)				
	rapid stop deceleration time	1–8 388 608 ms				
Number of occupied I/O points	32	32	32	32	32	32
Internal current consumption	510 mA	620	760	440	480	550
Dimensions (WxHxD)	45x90x95 mm	45x90x95	45x90x95	45x90x95	45x90x95	45x90x95
Order information	Art. no. 251448	251449	238095	251446	251447	238096

Single axis motion controller MR-MQ100



The MR-MQ100 allows a single axis to be completely controlled and synchronised to a separate encoder or virtual axis with no additional controller hardware like a PLC. Applications such as rotary cutters, flying saws and labelling can be realized cost-effectively. A complete range of essential functions are available, including encoder and virtual axis synchronization, registration, point to point positioning and user defined cam profiles. In addition, the hardware complements these powerful software features with built-in I/O and SSCNETIII motion networking capability as well as an Ethernet port.

The MR-MQ100 uses Mitsubishi Electric's simple but rugged optical fiber motion network SSCNETIII. A single fiber connection is all that's needed to provide full communication and control over all functions of the MR-J4-B servo amplifier regardless of capacity. A standard Ethernet connection is also provided to link the MR-MQ100 to the MT Developer2 software and to the control system.

- Stand-alone Motion Control System only with servo amplifier without additional hardware
- Optical high-speed SSCNETIII network
- Ethernet interface 100/10 Mbps
- High speed inputs for mark sensors
- External encoder input for axis synchronisation
- MC protocol Ethernet communication
- Increase of the number of inputs/outputs by connecting an I/O expansion board (MR-J3-D01) to the servo amplifier series MR-J3-BSafety.
- Integrated serial interface (RS422) for communication with HMI operator terminals

Specifications		MR-MQ100
Power supply		24 V DC $\pm 10\%$ (required current capacity: 400 mA)
Digital inputs (mark sensors)		4 inputs (24 V DC)
Digital outputs		2 outputs (24 V DC)
Synchronous encoder	signal type	A/B phase pulse train input
	voltage input/open-collector type (5 V DC)	Up to 800 kpps (after magnification by 4), up to 10 m
	differential input type	Up to 4 Mpps (after magnification by 4), up to 30 m
Peripheral interface		100 Mbps/10 Mbps Ethernet (for programming and additional options) SSCNETIII (for connection to servo amplifier with optical cable)
Positioning	method	(PTP (Point To Point) control, speed control/speed-position control, fixed-pitch feed, constant speed control, position follow-up control, speed control with fixed position stop, speed switching control, high-speed oscillation control, synchronous control (SV22))
	acceleration/deceleration control	Automatic trapezoidal acceleration/deceleration, S-curve acceleration/deceleration
	compensation	Backlash compensation, Electronic gear, Phase compensation
Servo program capacity		16 k steps
Number of positioning points		3200
Number of control axes		1 axis
Operation cycle		0.44 ms
Servo amplifier		MR-J3-BSafety/MR-J4-B over SSCNETIII
Programming language		Motion SFC, dedicated instruction, mechanical support language (SV22)
Memory back up (included)		Q6BAT
Cam function	number of cams	Up to 256 cam profiles may be stored internally.
	resolution per cycle	256, 512, 1024, 2048
	stroke resolution	32767
	control mode	Two-way cam, feed cam
Weight		kg 0.7
Dimensions (WxHxD)		mm 30x168x135 ^①
Order information		Art. no. 217705

① H without battery (Height with battery = 178 mm)

Stand-alone motion controller Q170MSCPU/Q170MSCPU-S1

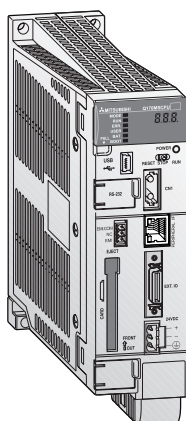

The Q170MSCPU/Q170MSCPU-S1 combines a PLC CPU, a Motion CPU and a power supply module into one compact unit. No base unit is required, although an extension base unit with standard PLC modules can be connected if required. An encoder interface is included as standard, enabling multiple axes synchronization with an external encoder.

The well-reputed mechanical support language (SV13, SV22) from the MELSEC System Q Motion Controller is incorporated.

- Small size
- Controls up to 16 axes
- Communication with servo amplifier via high-speed network SSCNETIII/H and a communication speed up to 150 Mbps.
- Programming and configuration is performed using the familiar software GX Works2 and MT Works2.
- Expandable with an extension base unit (up to 5 slots) and I/O modules, intelligent modules, and network-related modules.
- MC protocol Ethernet communication

Specifications	Q170MSCPU	Q170MSCPU-S1	
Motion-CPU	number of controllable axes	16	
	operation cycle	0.22 ms, 0.44 ms, 0.88 ms, 1.77 ms, 3.55 ms, 7.11 ms	
	programming languages	Motion SFC, dedicated instruction, mechanical support language (SV22)	
	servo program capacity	16 k steps	
	servo amplifier	MR-J3-BSafety over SSCNETIII/ MR-J4-B over SSCNETIII/H	
Interpolation functions	Linear interpolation for up to 4 axes, circular interpolation for 2 axes, helical interpolation for 3 axes		
PLC CPU	number of I/O points	4096 points	
	programming languages	Ladder, instruction list, SFC, structured text	
	program capacity	30 k steps (120 k bytes)	60 k steps (240 k bytes)
	processing speed	20 ns (LD instruction); 40 ns (MOV instruction)	9.5 ns (LD instruction); 19 ns (MOV instruction)
	total number of instructions	858 (including real number operation instruction)	
Positioning	method	(PTP (Point To Point) control, speed control/speed-position control, fixed-pitch feed, constant speed control, position follow-up control, speed control with fixed position stop, speed switching control, high-speed oscillation control, synchronous control (SV22))	
	acceleration/deceleration control	Automatic trapezoidal acceleration/deceleration, S-curve acceleration/deceleration	
	compensation	Backlash compensation, electronic gear, phase compensation	
Memory card interface	1 slot for memory card for MELSEC System Q		
Cam function	number of cams	Up to 256 cam profiles may be stored internally.	
	resolution per cycle	256, 512, 1024, 2048, 4096, 8192, 16384, 32768	
	stroke ratio data	-2147483648 to 2147483647	
	control mode	Two-way cam, feed cam	
Dimensions (WxD)	mm	52x178x135	
Order information	Art. no.	266524	266535

MELSEC Simple Motion module

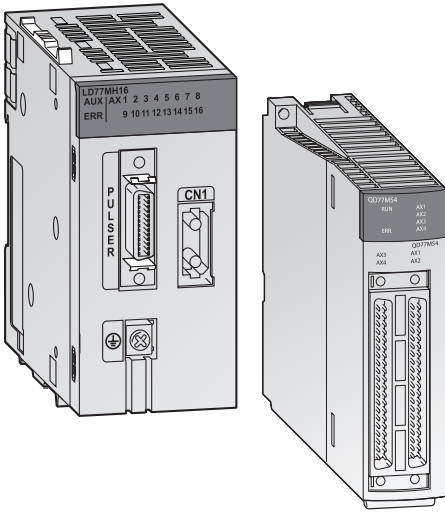

The MELSEC System Q and MELSEC L series lineup includes Simple Motion modules in addition to the regular positioning modules. Various control functions previously only possible with Motion Controllers, such as speed control, torque control, synchronous control and cam control, are now available with the Simple Motion modules. These functions can be realized with simple parameter adjustments and via the PLC program.

Mark sensors allow use in packaging industry, filling plants, etc., without additional optional modules. A function for automatic calculation of cam data for applications with rotating cutters is implemented – only by setting the length of the product and the synchronisation path. With positioning functions, like linear interpolation (up to 4 axes), circular interpolation (2 axes) and path control it is easy to realize different applications, like X-Y tables, sealing, etc.

Proved and tested programs for the QD75MH can be used, since the QD77MS and the LD77MH are compatible with the QD75MH.

- Compatible with QD75MH
- Up to 600 positions per axis
- External encoder input for axis synchronisation
- Electronic cam control
- High-speed digital inputs for mark sensors to capture encoder position, motor position etc.
- Parameterization, programming, diagnostics and test operation by GX Works2
- Certified PLCopen function blocks
- Communication between the Simple Motion module and servo amplifiers via the high-speed network SSCNETIII/SSCNETIII/H



Specifications	LD77MH4	LD77MH16	QD77MS2	QD77MS4	QD77MS16	
Number of controllable axes	4	16	2	4	16	
Interpolation functions	Linear interpolation for up to 4 axes, circular interpolation for 2 axes		2 axes linear and circular interpolation	Linear interpolation for up to 4 axes, circular interpolation for 2 axes		
Output type	SSCNETIII	SSCNETIII	SSCNETIII/H	SSCNETIII/H	SSCNETIII/H	
Output signal	Bus	Bus	Bus	Bus	Bus	
Servo amplifier	MR-J3-BSafety/MR-J4-B over SSCNETIII		MR-J3-BSafety over SSCNETIII/MR-J4-B over SSCNETIII/H			
Operation cycle	0.88 ms	0.88 ms/1.7 ms	0.88 ms	0.88 ms	0.88 ms/1.7 ms	
Positioning	method	PTP (Point To Point) control, path control (linear and arc), speed control, speed-position switching control, position-speed switching control, torque control				
	acceleration/deceleration control	Trapezoidal acceleration/deceleration, S-curve acceleration/deceleration				
	compensation	Backlash compensation, electronic gear, near pass function				
	OPR control	5 different methods				
Number of positioning points	600 per axis (can be set with GX Works2 or PLC program)					
External input signals	encoder	1 encoder, A/B phase				
	high-Speed Inputs	4 digital inputs [DI1–DI4]				
Cam function	storage area cam data	256 kbytes				
	number of cams	Max. 256 (depends on resolution)				
	resolution per cycle	256, 512, 1024, 2048, 4096, 8192, 16384, 32768				
	stroke resolution	2–16284				
I/O points	32	32	32	32	32	
Dimensions (WxHxD)	mm	45x90x98.5	45x90x98.5	27.4x98x90	27.4x98x90	
Order information	Art. no.	241243	241244	248702	248703	248704

MELSEC System Q-Motion CPU

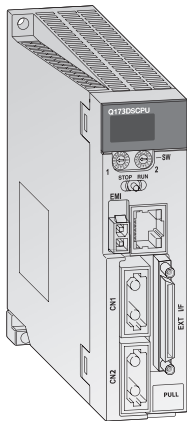

The Q-Motion controller CPU controls and synchronises the connected servo amplifiers and servo motors. A motion system besides the controller CPU, also includes a PLC CPU. Only after combining a highly dynamic positioning control CPU and a PLC, an innovative motion control system is created.

While the Motion CPU controls large-scale servo movements the PLC CPU is responsible for the machine control and the communication.

- Using multiple CPUs to distribute the load improves the overall performance of the whole system
- Use of up to 3 motion CPUs within one system
- Large scale control system for up to 96 axes per system
- Interpolation of 4 axes simultaneously
- Electronic cam control
- Virtual and real master axes
- Integration in the high-speed SSCNETIII/H network for communication with high-performance servo amplifiers at up to 150 Mbps

Specifications	Q172DSCPU	Q173DSCPU
Type	Motion CPU	Motion CPU
I/O points	8192	8192
No. of control axes	16	32
Interpolation functions	Linear interpolation for up to 4 axes, circular interpolation for 2 axes, helical interpolation for 3 axes	
Positioning	method	PTP (point to point), speed control/speed-position control, fixed pitch feed, constant speed control, position follow-up control, speed switching control, high-speed oscillation control, synchronous control (SV22)
	acceleration/deceleration control	Automatic trapezoidal acceleration/deceleration, S-curve acceleration/deceleration
	compensation	Backlash compensation, electronic gear
Programming language	Motion SFC, dedicated instructions, software for conveyor assembly (SV13), virtual mechanical support language (SV22)	
Servo program capacity	16 k steps	
No. of positioning points	3200	
Interfaces	Ethernet 100 Mbps/10Mbps (for programming and additional options), SSCNETIII/H (for connection to servo amplifier with optical cable) (USB, RS232C via PLC-CPU)	
Servo amplifier	MR-J3-BSafety over SSCNETIII/ MR-J4-B over SSCNETIII/H	
Dimensions (WxHxD)	mm 27.4x120.5x120.3	27.4x120.5x120.3
Order information	Art. no. 248700	248701

MELSEC System Q-Motion system modules

Servo external signals interface module Q172DLX

The Q172DLX input module is used in conjunction with a Q Motion CPU to capture external servo signals.

Up to 8 axes can be evaluated per module. In this way, proximity dog sensor, upper/lower limit switch, stop signal input and operating mode switching input can be easily incorporated into the system.

- 32 address points for 8 axes for each 4 inputs
- Bipolar inputs for positive and negative logic
- Galvanic isolation of the inputs by means of photocoupler
- Shortest response time of <0.4 ms
- Modular extension possible

Serial absolute synchronous encoder interface module Q172DEX

The serial absolute synchronous encoder interface module Q172DEX is a motion system module for receiving and evaluating up to two serial absolute-value encoders. (Incremental encoders

cannot be connected.) Via an external encoder it is possible to feed a setpoint source to the motion system, which in turn is programmed as a master axis.

In addition to the interfaces for the signals of two absolute value encoders, the Q172DEX has two digital inputs with ultra-rapid response-times.

- Serial communication (2.5 Mbps)
- Resolution of 22 Bit Q170ENC-W8
- Voltage-failure security of the absolute values by means of built-in buffer battery
- Shortest response times of <0.4 ms
- Modular extension possible

Manual pulse generator interface module Q173DPX

The manual pulse generator interface module is used in a motion system to receive the signals of up to 3 external incremental encoders or manual impulse generators (hand wheels).

In addition to the inputs for the encoders, the Q173DPX has three digital inputs with which

the encoder signal counting procedure can be started (encoder start signal).

- Bipolar inputs for positive and negative logic
- Galvanic isolation of the inputs by means of photo coupler
- Shortest response times of <0.4 ms
- Modular extension possible

Safety signal module Q173DSXY

The safety signal module is an input/output extension with 20 safety input points x2 paths and 12 safety output points x2 paths to pass input/output information to the Motion CPU and PLC CPU module.

With the safety observation function the system complies to the safety functions: STO, SS1, SS2, SOS, SLS, SBC, SSM (IEC 61800-5-2: 2007)

MELFA Robot Systems

Example of a robot system configuration

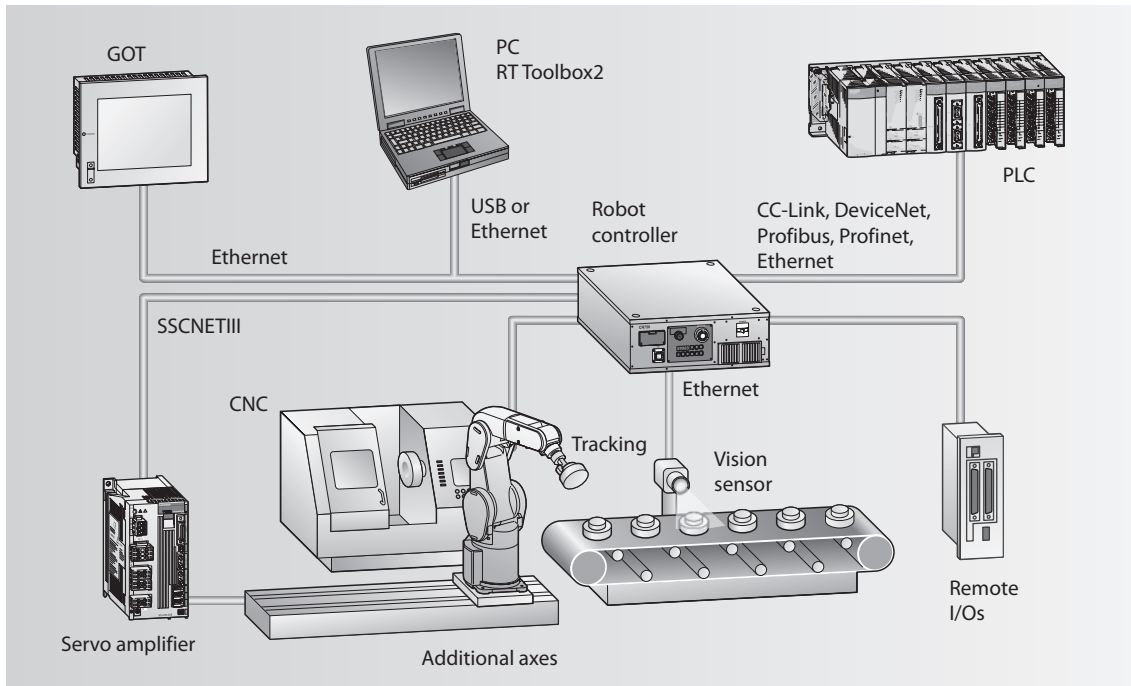

Practical functions for all applications

9 MELFA Robot Systems

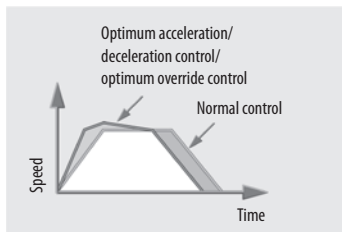

Automatic acceleration and braking ramp optimisation for faster cycle times

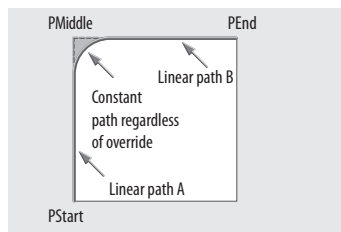

Continuous path function for faster cycle times

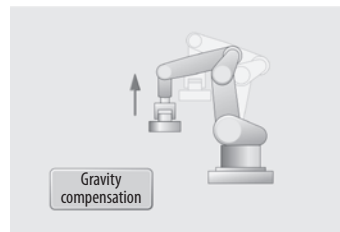

Gravity compensation for greater positioning and palletising precision

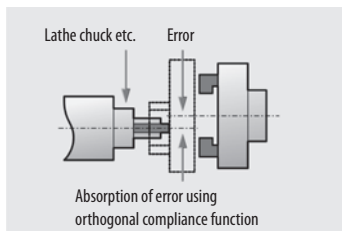

Orthogonal "compliance control" function for interactive response to opposing forces

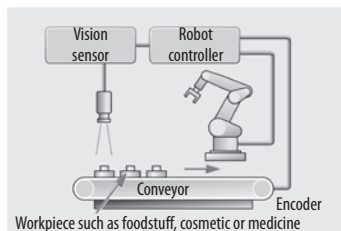

Object tracking function for faster cycle times

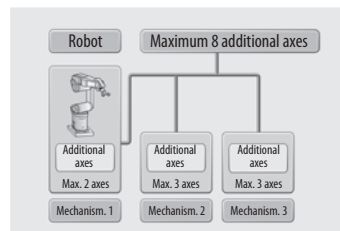

Control functions for up to 8 additional axes

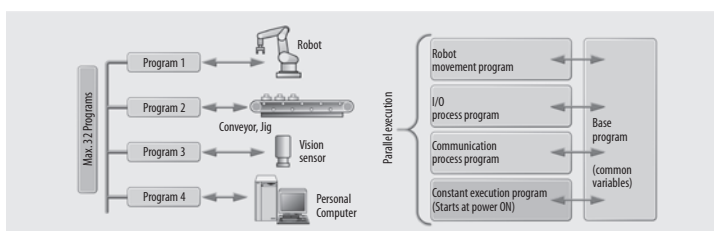

Multitasking function for parallel execution of multiple tasks

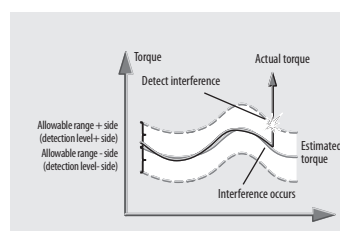

The sensorless crash detection reduces robot, machine and workpiece damages

RV-2FB articulated-arm robots – the powerful compact class

The compact and light RV-2FB can be seamlessly integrated into different automation systems. Flexibility and the wide range of motion permits acting in applications with limited space, like mounting, assembling, palletising, sorting or bonding.

Even the basic model is available with fully equipped standard controller or as SPS robot with integration into the iQ Platform (see for more details on page 30).

Model	RV-2FB-D1-S15	RV-2FB-Q1-S15
Degrees of freedom	6	
Maximum payload	2.0 kg	
Gripper flange reach	504 mm	
Repeatability	±0.02 mm	
Max. speed	4955 mm/s	
Controller type	CR750-D	CR750-Q + Q172DRCPU
Operating range	J1	480 (±240)
	J2	240 (-120+120)
	J3	160 (0+160)
	J4	400 (±200)
	J5	240 (-120+120)
	J6	720 (-360+360)
Robot weight	19 kg	
Protection	IP30	
Order information	Art. no.	255211
		255213

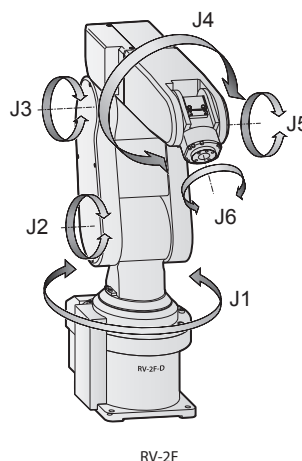

RV-4FLM articulated-arm robots – the easy access to high-performance

The RV-4F series of robots have been designed to be very simple to integrate into an existing automation cell. Features such as the direct control over local I/Os allows the robot to interact directly with sensors and actuators, speeding up and simplifying system building. Communicating with other automation plant is an important area of any automation cell.

The RV-4F series has been optimised with a choice of major networking technologies:

Ethernet, DeviceNet, Profibus DP, Profinet and CC-Link. For complex automation cells where movement is restricted, or there is a large distance between working points, the RV-4F robots can control up to 8 additional axes to its standard robot arm configuration.

Two of these axes can be interpolated allowing easy and efficient movement around obstructions in combination with the robot arm.

The other six axes can be used to control elements such as linear slides to move the robot between work stations.

The robots are available in different versions with varying arm lengths and for stand-alone use or as a part of the iQ Platform (see page 30 for more details). Robots arms have IP67 protection as standard.

Model	RV-4FLM-D1-S15	RV-4FLM-Q1-S15
Degrees of freedom	6	
Maximum payload	4.0 kg	
Gripper flange reach	649 mm	
Repeatability	±0.02 mm	
Max. speed	9048 mm/s	
Controller type	CR750-D	CR750-Q + Q172DRCPU
Operating range	J1	480 (±240)
	J2	240 (-120+120)
	J3	164 (0+164)
	J4	400 (±200)
	J5	240 (-120+120)
	J6	720 (±360)
Robot weight	41 kg	
Protection	IP67 standard	
Order information	Art. no.	255268
		255272

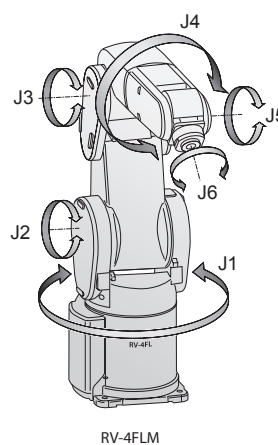

RV-7FM/RV-7FLM articulated-arm robots – the reliable mid-range solution

The RV-7F with handling payloads of up to 7 kg sets new benchmark standards for speed, flexibility, ease of integration and simplicity of programming. With a pick & place cycle of 0.32 seconds (12" test), the robots of the RV-7F series provide the fastest motion in its class. Ethernet, USB, tracking, camera connection and additional axis connections are standard in all MELFA Robot Series.

Two of these axes can be interpolated allowing easy and efficient movement around obstructions. The other six axes can be used to control elements such as linear slides to move the robot between work stations.

The robots are available in different versions with varying arm lengths and for stand-alone use or as a part of the iQ Platform (see page 30 for more details).

For the iQ Platform type robots an anti-collision function is available to prevent automatically a collision between robots which are working close together. Also RV-7F series robot arms have IP67 protection as standard.

Model	RV-7FM-D1-S15 RV-7FM-Q1-S15	RV-7FLM-D1-S15 RV-7FLM-Q1-S15	
Degrees of freedom	6	6	
Maximum payload	7.0 kg	7.0 kg	
Gripper flange reach	712 mm	908 mm	
Repeatability	±0.02 mm	±0.02 mm	
Max. speed	11064 mm/s	10977 mm/s	
Controller type	CR750-D/CR750-Q + Q172DRCPU	CR750-D/CR750-Q + Q172DRCPU	
Operating range	J1	480 (±240)	
	J2	240 (-115—+125)	
	J3	156 (-0—+156)	
	J4	400 (±200)	
	J5	240 (-120—+120)	
	J6	720 (±360)	
Robot weight	65 kg	67 kg	
Protection	IP67 standard		
Order information	Art. no.	255275 255279	255276 255280

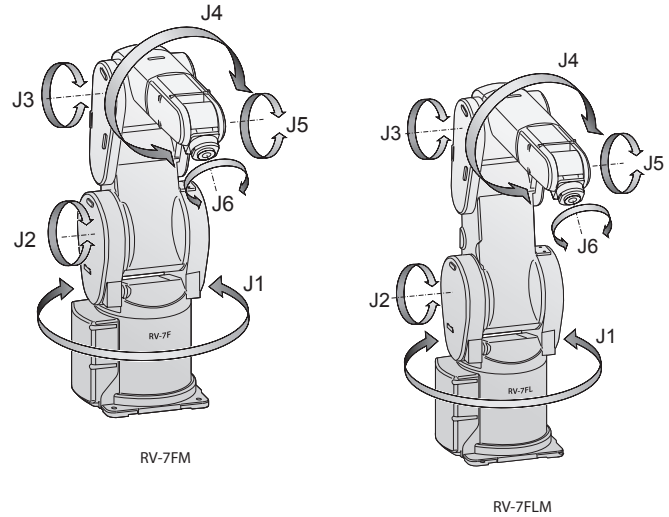

RV-12SD/RV-12SQ/RV-12SDL/RV-12SQL articulated-arm robots – exceptional power and reach

With handling payloads of 12 kg, a truly impressive maximum workspace radius of 1,385 mm and exceptional precision (repeatability: ±0.05 mm) the RV-SD/RV-SQ series is predestined for handling parts in industrial production and for chaining plant stations. An IP65 protection rating provides the capabilities needed for heavy-duty applications, like those in the motor industry suppliers sector. The state-of-the-art

technology used in this series drastically reduces work cycle times. All the new robots complete the 12-inch test in less than a second!

Ethernet link are just a few of the impressive highlights of these high-performance robot controllers. Other features include automatic conveyor belt tracking, crash detection without sensors and a wide range of powerful functions for work cycle optimisation.

Multifunctional robot controllers

The robots are controlled by the multitasking controller CR2D. Connection of any image processing system, control of up to 8 additional axes and high-speed communication via an

Model	RV-12SD-S315 RV-12SQ-S315	RV-12SDL-S315 RV-12SQL-S315	
Degrees of freedom	6	6	
Maximum payload	12 kg	12 kg	
Gripper flange reach	1086 mm	1385 mm	
Repeatability	±0.05 mm	±0.05 mm	
Max. speed	9600 mm/s	9500 mm/s	
Controller type	CR2DA/QR2QA + Q172DRCPU	CR2DA/CR2QA + Q172DRCPU	
Operating range	J1	340 (-170—+170)	
	J2	230 (-100—+130)	
	J3	290 (-130—+160)	
	J4	320 (-160—+160)	
	J5	240 (-120—+120)	
	J6	720 (-360—+360) (expandable)	
Robot weight	93 kg	98 kg	
Protection	IP54 (J1–J3), IP65 (J4–J6)		
Order information	Art. no.	235687 235697	235688 235698

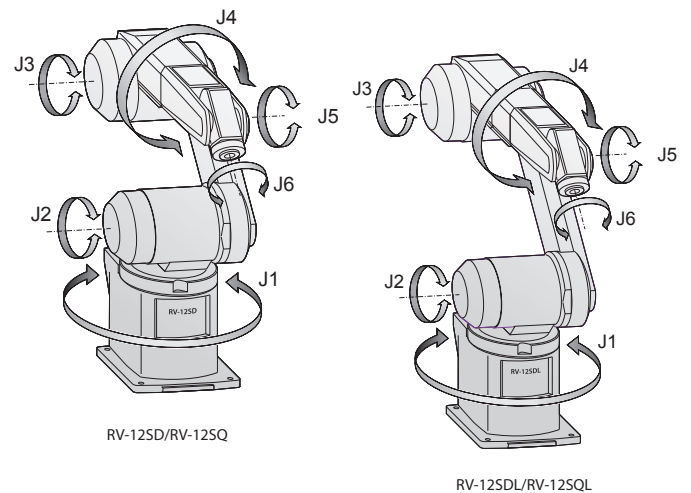

RP series SCARA robots – outstanding speed plus high precision

The RP series is in its element in all applications where parts have to be processed quickly and precisely in cramped quarters. It has an installation footprint of just 200x160 mm and a reach of 236 mm, and it can place components

with a precision of ± 0.005 mm. This combination of compact dimensions and great precision predestine the RP robots for micro-handling tasks like micro-assembly and the population and soldering of SMD circuit boards for mobile

phones. The robots of this series are incomparably more flexible than traditional automated machines, and this pays off in greatly enhanced efficiency and higher productivity.

Model	RP-1ADH	RP-3ADH	RP-5ADH
Degrees of freedom	4	4	4
Maximum payload	1 kg	3 kg	5 kg
Controller type	CR1DA	CR1DA	CR1DA
Operating range	WxD (mm)	150x105 (A6 size)	210x148 (A5 size)
	J3 vertical motion (mm)	30	50
Repeat position accuracy	J4 (deg.)	± 200	± 200
	X-Y surface (mm)	± 0.005	± 0.008
Robot weight	J3 vertical motion (mm)	± 0.01	± 0.01
	J4 (deg.)	± 0.02	± 0.03
Order information	Art. no. 252843	252844	252885

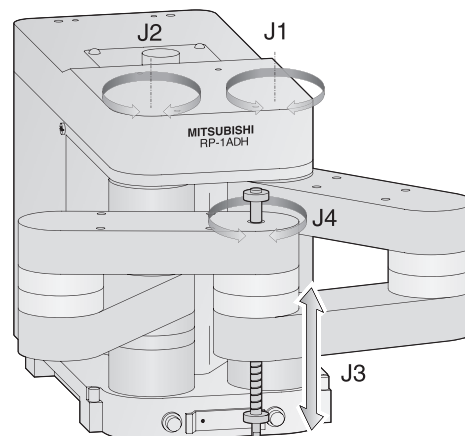

RH-3SDHR/SQHR SCARA robots – overhead installation for minimum space requirements

No reference point travel

Travel and position are measured with absolute encoders, so that the robot can start work as soon as it is powered up without wasting time with reference point traverses. In fact, the robot can even resume at the point where it left off after power failures and emergency shutdowns in the middle of a movement sequence. In most cases, this eliminates the need to reset the entire system.

Optimum gripper connections

Pneumatic hoses and signal connection lines are routed inside the robot, making it easy to connect grippers and sensors.

Unpack, calibrate, start work

You can start work almost as soon as you have unpacked the robot and installed the arm assembly. You only have to enter the reference

point data recorded at the factory, then the robot is ready to execute the first movements.

SCARA robots are high-performance systems for mechanical assembly, material handling, packaging and other applications that require fast and precise automation. The short cycle period of less than 0.5 seconds enables a movement sequence of 25 mm vertical lift, 300 mm horizontal traverse and 25 mm vertical and lower return.

Model	RH-3SDHR3515	RH-3SQHR3515
Degrees of freedom	4	
Maximum payload	3 kg	
Controller type	CR2DA	CR2QA + Q172DRCPU
Gripper flange reach	350 mm	
Operating range	J1 (deg.)	450 (± 225)
	J2 (deg.)	450 (± 225)
	J3 (Z) (mm)	150
	J4 (θ axis) (deg.)	1440 (± 720)
Repeatability X-Y direction	± 0.01 mm	
Max. speed (mm/s)	6267 (J1, J2)	
Robot weight	24 kg	
Protection	IP65	
Degree of cleanliness*	ISO 3 (optional)	
Order information	Art. no. 237390	237391

* according to ISO 14644-1

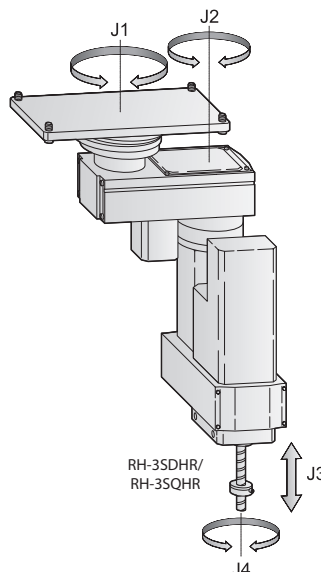

RH-FH SCARA robots – specialists for palletising

More productivity and efficiency

SCARA robots are ideal for sorting, palletising and component installation due their short cycle time. The robots of the RH-F series achieve the highest speeds in their class thanks to the new motors developed by Mitsubishi Electric, high arm rigidity and unique control technology. The resulting reduced cycle time of only 0.29 seconds for a 12" cycle make for significantly increased productivity and improved continuous operation.

Easy integration and application

Straight from the factory, the RH-F series offers many features which are only available as optional extras on comparable products. For example, every model has connections for pneumatic grippers, Ethernet, USB, tracking functions, camera interface, hand I/O, additional axis controller and an interface for GOT HMIs with freely programmable user interfaces. The standard grease is foodgrade H1 grease – ideal for the food and beverage industry.

An ISO Level III cleanroom model is also available for pharmaceutical and microelectronics applications.

The RH-6/12/20FH has the tried-and-tested protection class IP54 for industrial systems which protects against dust and spray water. For use in particularly contaminated or dusty environments, the model can be retrospectively upgraded to IP65 at relatively little cost and without any problems thanks to the closed housing concept.

Model	RH-3FH5515-D1-S15 RH-3FH5515-Q1-S15	RH-6FH5520-D1-S15 RH-6FH5520-Q1-S15	RH-12FH8535N-D1-S15 RH-12FH8535N-Q1-S15	RH-20FH10035N-D1-S15 RH-20FH10035N-Q1-S15
Degrees of freedom	4	4	4	4
Maximum payload	3 kg	6 kg	12 kg	20 kg
Controller type	CR750-D/CR750-Q + Q172DRCPU	CR750-D/CR750-Q + Q172DRCPU	CR750-D/CR750-Q + Q172DRCPU	CR750-D/CR750-Q + Q172DRCPU
Gripper flange reach	550 mm	550 mm	850 mm	1000 mm
Operating range	J1 (deg.)	340 (±170)	340 (±170)	340 (±170)
	J2 (deg.)	290 (±145)	290 (±145)	306 (±153)
	J3 (Z) (mm)	150	200	350
	J4 (θ axis) (deg.)	720 (±360)	720 (±360)	720 (±360)
Repeatability X-Y direction	±0.012 mm	±0.012 mm	±0.015 mm	±0.02 mm
Max. speed (mm/s)	8300	8300	11350	13283
Robot weight	32 kg	37 kg	69 kg	77 kg
Protection	IP20	IP54 (IP65 optional)		
Order information	Art. no.	250377 250380	250383 250389	254377 254383
		254388 254392		

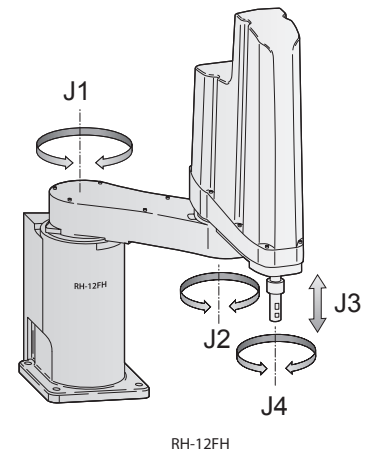

Powerful controller



Every robot system has its own compact, modular robot controller, which contains the CPU and the power electronics for controlling the robot.

Mitsubishi Electric's robot controllers have a particularly slim, compact design. No matter which Mitsubishi robot you use the programming language and options are always the same. You can add special application functions by inserting expansion option cards in the slots in the controllers. Therefore it is possible, to integrate the controller into different types of networks.

The CR750 Controller has already implemented functions like Ethernet- and USB-Connection, Additional Axes Control over SSCNETIII and Tracking Encoder interface as a standard.

A teaching box for defining the robots' working positions can be connected to the controller's RS422 port. The teaching box can also be used for testing the entire program sequence.

The interfaces make it possible to develop programs with a powerful PC software package with a user-friendly interface, and to perform 3D simulations of complete work cells.

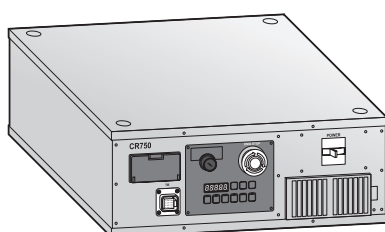

Characteristics/Functions	CR1DA	CR2DA/CR2QA	
Shipped with robot	RP-1ADH/3ADH/5ADH	RH-3SDHR/RH-3SQHR RV-12SD/12SDL/12SQ/12SQL	
Number of controllable axes	6 robot axes + 2 interpolation axes + 6 independent axes		
Interfaces	USB, Ethernet, RS232 (all integrated)		
Memory capacity	no. of teaching points	Max. 13000	
	no. program steps	Max. 26000	
	no. of programs	256	
External inputs/outputs	general purpose I/Os	Optional	
	hand open/close	8	
	emergency stop I/Os	1	2 (redundant) in accordance with DIN EN ISO 10218
	door switch input	1	2 (redundant)
Power supply	1~180-253 V AC; 50/60Hz		
Dimensions (WxHxD)	mm	270x200x290	470x200x400

Characteristics/Functions	CR750-D	CR750-Q + Q172DRCPU	
Shipped with robot	RV-2F/4F/4FL/7F/7FL RH-3FH/6FH/12FH/20FH		
Number of controllable axes	6 robot axes + 2 interpolation axes + 6 independent axes		
Interfaces	Ethernet, USB, SSCNETIII		
Memory capacity	no. of teaching points	39000	13000
	no. program steps	78000	26000
	no. of programs	512	256
External inputs/outputs	general purpose I/Os	up to 256	up to 8192
	hand open/close	8 inputs/8 outputs	
	emergency stop I/Os	1 (redundant)	
	door switch input	1 (redundant)	
Power supply	Input voltage	1~180-253 V AC; 50/60Hz	
	Power consumption kVA	0.5-2.0	
Dimensions (WxHxD)	mm	430x174x425	430x174x425

F-D and F-Q series

High flexibility and full production line integration can easily be realised with F-Q-robot systems. This is an iQ Platform based robot controller which directly communicates with the iQ PLC CPU and all its modules. This makes the complete range of iQ system modules (I/O, networking, special function, etc.) available to an F-Q system.

F-D-system robots are also available as F-Q-robot systems. Powerful features like fully integrated HMI terminal application monitoring, communication on most of the widely used networks and high performance MES functionality for 100 % data logging are just some of the features of this system.

The F-Q-system provides cost reduction during installation and through to production by reducing the cycle time for every single product.

For the design of robotic systems, Mitsubishi Electric offers unrivalled choice. Our two key robot families cover all requirements no matter how complex or demanding your application. Our F-D series offers a high level of performance for maximum productivity, while our F-Q series extends these benefits with the highest level of integration available from any robotic system anywhere.

- Improved responsiveness through high-speed communications
- Reduced wiring and number of units used
- Direct communication between CPU units
- Batch management of multiple robots
- Direct control between I/O units
- Shared memory expansion
- GOT connection (transparent function) (for GOT1000 series)
- GOT backup/restore functions (supported on GT14, GT15 and GT16)
- Direct execution function for programmable controllers

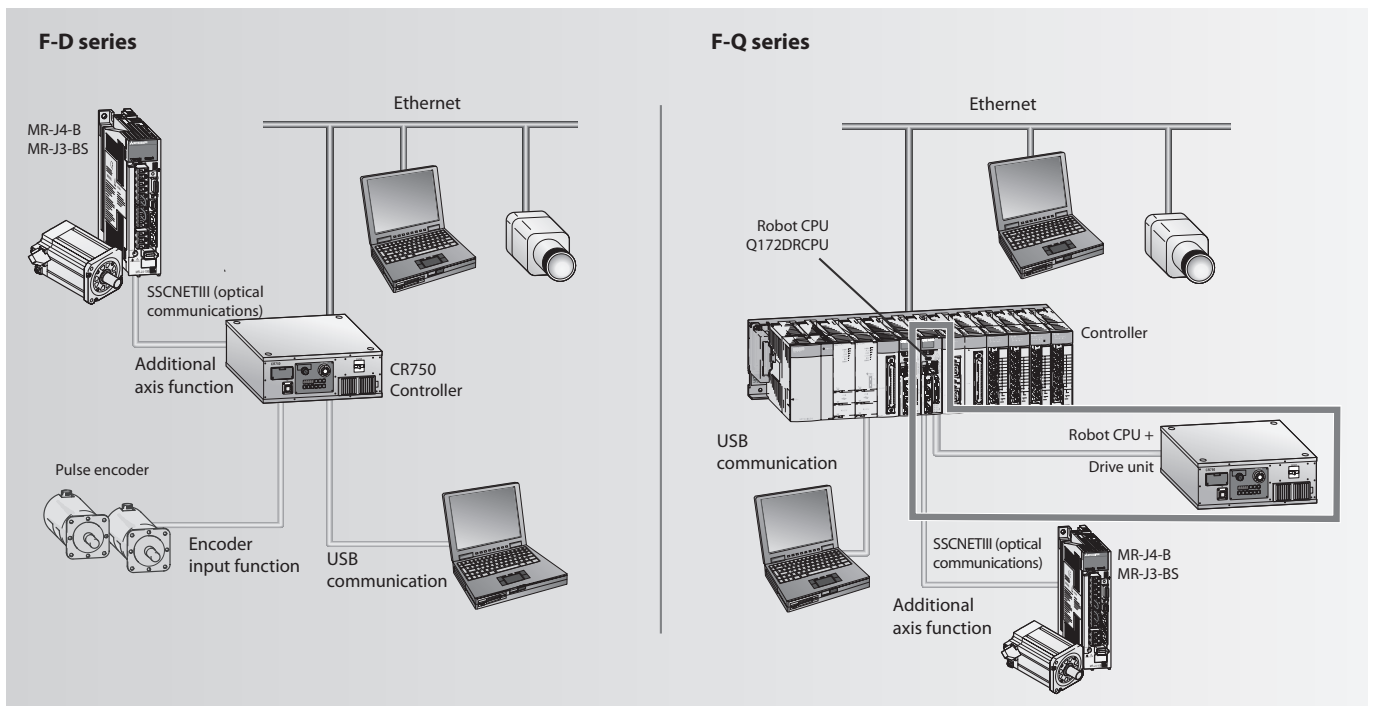

Robots teach panel for operation and programming

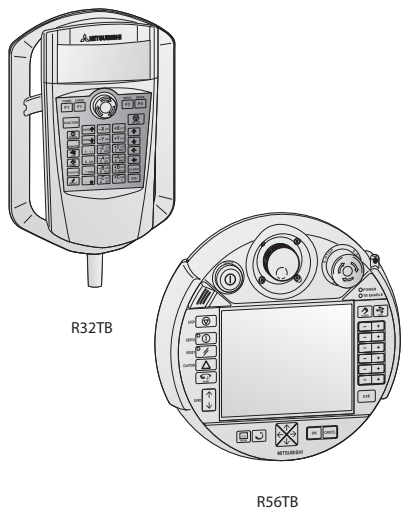

R32TB

R56TB

The R56TB teach panel is a multifunctional control and programming terminal for all Mitsubishi Electric F series, SD/SQ series and ADH series robots. Its intuitive user interface makes it easy to control robot movements and perform extensive diagnostics and monitoring functions for users of all levels. All safety-critical functions such as robot movements are assigned to keys.

Programming and monitoring functions are accessed and adjusted quickly and easily via the bright 6.5" touchscreen display.

In addition to controlling robot movements the terminal has many other functions: For example, writing programs with a virtual on-screen keyboard and monitoring all system status parameters, inputs and outputs, including those accessed via the network.

Specifications	R56TB	R32TB
Compatibility	All Mitsubishi Electric F series, SD/SQ series and ADH series robots	
Functions	Operation, programming and monitoring of all robot functions	
Programming and monitoring	Read out information, also during operation; program editing with virtual keyboard; display up to 14 lines of program code; I/O monitoring for up to 256 inputs and 256 outputs; service display with information on maintenance intervals; error display with details of the last 128 alarms	Read out information, also during operation, program editing with T9-Key standard, supervising of I/Os, display of error alarms, Right-/Left-Hand usage, 36 keys for operation selection
Software	Integrated operating system software with menu-based user interface	
Menu navigation (language)	German, English, French, Italian	English, Japanese
Display	type/dimensions	Monochrome LCD graphic display (24 characters x 8 lines)
	technology	LCD with backlight
Interfaces	USB, Ethernet for connection to the robot controller	RS422 for connection to the robot controller
Connection	Direct connection to the robot controller, cable length 7m	
Protection rating	IP65	IP65
Weight	kg 1.25	0.9
Order information	Art. no. 218854	214968

Options overview for all robots

Option	Marking	RV-2FB	RV-4FLM	RV-7FM/ RV-7FLM	RV-12SD/SQ, RV-12SDL/ SQL	RH-3FH	RH-6FH	RH-12FH/ RH-20FH	RH-3SDHR/ RH-3SQHR	RP- 1/3/5ADH	Art. no.
Teaching Box	R32TB	●	●	●	●	●	●	●	●	●	214968
Teaching Box	R56TB	●	●	●	●	●	●	●	●	●	218854
Single valve set	1E-VD01E	●									47397
Double valve set	1E-VD02E	●									47398
Single valve set	1F-VD01E-02		●	●							255281
Double valve set	1F-VD02E-02		●	●							255282
Triple valve set	1F-VD03E-02		●	●							255283
Quadruple valve set	1F-VD04E-02		●	●							255284
Single valve set	1S-VD01E-01				●			●			153057
Double valve set	1S-VD02E-01				●			●			153058
Triple valve set	1S-VD03E-01				●			●			153059
Quadruple valve set	1S-VD04E-01				●			●			153062
Single valve set	1A-VD01E-RP									●	129780
Double valve set	1A-VD02E-RP									●	129781
Triple valve set	1A-VD03E-RP									●	129792
Quadruple valve set	1A-VD04E-RP									●	129793
Single valve set	1S-VD01E-05								●		238282
Double valve set	1S-VD02E-05								●		238283
Triple valve set	1S-VD03E-05								●		238284
Quadruple valve set	1S-VD04E-05								●		238375
Single valve set	1F-VD01E-01					●	●				250470
Double valve set	1F-VD02E-01					●	●				250471
Triple valve set	1F-VD03E-01					●	●				250472
Quadruple valve set	1F-VD04E-01					●	●				250473
CC-Link interface *	2D-TZ576	●	●	●	●	●	●	●	●	●	219063
Profibus interface *	2D-TZ577	●	●	●	●	●	●	●	●	●	218861
I/O interface *	2D-TZ378	●	●	●	●	●	●	●	●	●	218862
Pneumatic hand interface *	2A-RZ375				●				●	●	124657
Hand signal output cable	1A-GR200-RP									●	129778
	1F-GR355-02		●	●							255285
	1S-GR355-01		●	●	●						153078
	1F-GR60S-01					●	●	●			250467
Hand signal input cable	1S-HC30C-11	●									257063
	1A-HC200-RP									●	129779
	1F-HC355-02		●	●							255286
	1S-HC25C-01				●						153079
	1F-HC35C-01					●	●				250474
	1F-HC35C-02							●			254395
Gripper output connector	R-SMR-09V-B									●	132112
Gripper input connector	R-SMR-10V-N									●	132113
Hand signal output connector	S-series Hand OUTPUT	●	●	●	●	●	●	●	●		164814
Hand signal input connector	S-series Hand INPUT	●	●	●	●	●	●	●	●		164815
Internal wiring and piping set	1F-HS304S-01					●					250468
	1F-HS408S-01						●				250469
	1F-HS604S-01							●			254396
Extension cable for fixed installation in a drag chain	1S-05CBL-01		●	●	●		●	●	●		155827
	1S-10CBL-01		●	●	●		●	●	●		155830
	1S-15CBL-01		●	●	●		●	●	●		155665
	1S-05CBL-03	●				●					165967
	1S-10CBL-03	●				●					165968
	1S-15CBL-03	●				●					165969
Extension cable for flexible installation in a drag chain	1S-05LCBL-01		●	●	●		●	●	●		157582
	1S-10LCBL-01		●	●	●		●	●	●		157583
	1S-15LCBL-01		●	●	●		●	●	●		157594
	1S-05LCBL-03	●				●					165970
	1S-10LCBL-03	●				●					165971
	1S-15LCBL-03	●				●					165972
Connection cable for I/O interface *	2D-CBL05	●	●	●	●	●	●	●	●	●	218857
	2D-CBL15	●	●	●	●	●	●	●	●	●	218858

* only for D series

The complete solution for line and load side

Mitsubishi Electric offers the whole line from Air Circuit Breakers over Low Voltage Switchgear to Magnetic Contactors and Thermal Overload Relays.

A complete breaker program for complete, all-round protection.

SUPER AE series air circuit breakers

The SUPER AE air circuit breaker family consists of models from 1000 to 6300 A with a broad range of adjustable breaking capacities.

At the lower end of the scale the smallest current setting I_n is 125 A, with the AE1000 model. With the AE6300, the maximum possible setting is a full 6300 A.

Features include:

- Complete breaker program
- Frame size from 1000 A to 6300 A
- Wide performance range
- Breaking capacity up to 130 kA
- Growing power demands
- Optimum overload tripping system
- Additional disconnectors available

WSS series moulded case circuit breakers

The MCCBs of the Mitsubishi Electric breaker series are amongst the smallest compact circuit breakers in the world with electronic overload indication. The system is based, among other things, on the well-known and proven microprocessor technology. The WSS breaker series meets national and international protection ratings according to VDE, EN, and IEC standards for industrial applications as well as for extended shipping demands. The innovative tripping technology guarantees a high reliability and highest protection.

The highlights are

- 3 A to 1600 A rated capacity (3- and 4-pole)
- Interchangeable relay unit (thermal type or electronic type)
- Available in fixed and slot-in versions
- Breaking capacity up to 200 kA
- Additional disconnectors available

MS-N series magnetic contactors and thermal overload relays

Compact, modular extensions and an energy-saving design – these are the main requirements set by users of contactors and auxiliary contactors.

MS-N meets these requirement plus:

- Easy mounting and wiring
- Easy inspection
- Built-in surge absorber (from S-N50)
- Safety terminal functions
- Improvement of electromagnet
- International standard models

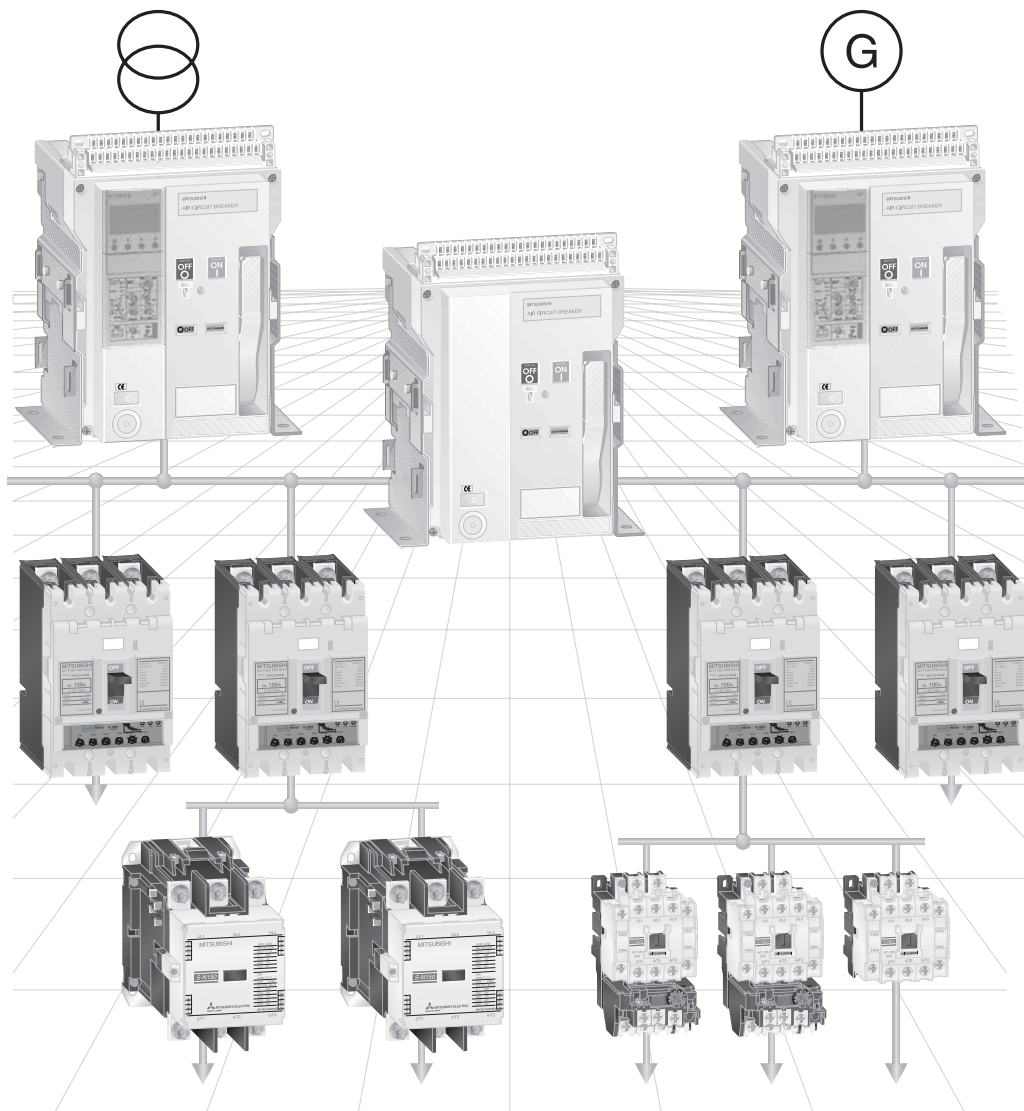

SUPER AE series air circuit breakers (AE-SW series)

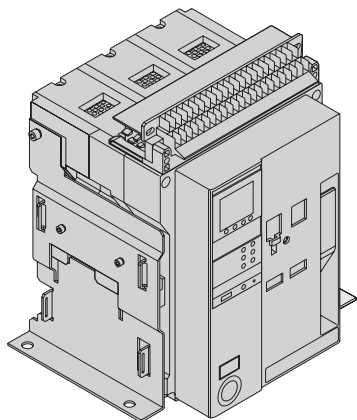

Built for the global demands of the 21st century

Mitsubishi Electric offers a really complete range of circuit breakers.

The World Super AE-SW air circuit family consist of models from 1000 to 6300 A and are available in both 3 and 4 pole versions with fixed or drawout configurations to suit your individual requirements. There are only 3 standard sizes, making planning much easier.

The development target was based on the features:

- Simple operation for maximum user-friendliness
- Flexible installation and customised protection for your systems
- Class leading performance range and extended service life
- Enhanced network support for comprehensive monitoring and control

Type	AE1000-SW				AE1250-SW				AE1600-SW				AE2000-SWA				AE2000-SW				AE2500-SW				AE3200-SW				AE4000-SWA				AE4000-SW				AE5000-SW				AE6300-SW							
Frame type	1																2																3															
Rated current I _n (A) 40 °C	1000				1250				1600				2000				2000				2500				3200				4000				4000				5000				6000							
Max. rated operational voltage U _e (V)	690																690																690															
Rated insulation voltage U _i (V)	1000																1000																1000															
Rated impulse withstand voltage U _{imp} (kV)	12																12																12															
Suitable for isolation	●																●																●															
Category	B																B																B															
Pollution degree	3																3																3															
Number of poles	3	4	3	4	3	4	3	4	3	4	3	4	3	4	3	4	3	4	3	4	3	4	3	4	3	4	3	4	3	4	3	4	3	4														
Rated current I _n (A) adjustment range at 40 °C	500–1000				625–1250				800–1600				1000–2000				625–2000				1250–2500				1600–3200				2000–4000				2000–4000				2500–5000				3150–6300							
Rated current of neutral pole (A)	1000				1250				1600				2000				2000				2500				3200				4000				2000				2500				3150							
Rated service short-circuit breaking capacity a I _{cs} (kA, rms)	690 V AC		65		690 V AC		65		690 V AC		65		690 V AC		65		690 V AC		65		690 V AC		65		690 V AC		65		690 V AC		65		690 V AC		65													
I _{cs} = I _{cr} = 100 %	400 V AC		65		400 V AC		65		400 V AC		65		400 V AC		65		400 V AC		65		400 V AC		65		400 V AC		65		400 V AC		65		400 V AC		65													
Rated short-time withstand current (kA rms) I _{sw}	1 s		65		1 s		65		1 s		65		1 s		65		1 s		65		1 s		65		1 s		65		1 s		65		1 s		65													
Operating cycles ^② (ON/OFF)	without rated current		25000		without rated current		25000		without rated current		25000		without rated current		25000		without rated current		25000		without rated current		25000		without rated current		25000		without rated current		25000		without rated current		25000													
Connecting terminal	horizontal		●		horizontal		—		horizontal		—		horizontal		—		horizontal		—		horizontal		—		horizontal		—		horizontal		—		horizontal		—													
	vertical		● ^③		vertical		●		vertical		● ^③		vertical		●		vertical		● ^③		vertical		●		vertical		● ^③		vertical		●		vertical		● ^③													
	frontal		● ^③		frontal		—		frontal		● ^③		frontal		—		frontal		—		frontal		—		frontal		—		frontal		—		frontal		—													
Outline dimensions (mm) WxHxD	fixed type		3-pole: 410x340x290		fixed type		4-pole: 410x425x290		fixed type		3-pole: 410x475x290		fixed type		4-pole: 410x605x290		fixed type		3-pole: 414x873x290		fixed type		4-pole: 414x1003x290		fixed type		3-pole: 414x873x290		fixed type		4-pole: 414x1003x290		fixed type		4-pole: 414x1003x290													
	draw-out type		3-pole: 430x300x368		draw-out type		4-pole: 430x385x368		draw-out type		3-pole: 430x435x368		draw-out type		4-pole: 430x565x368		draw-out type		3-pole: 430x439x368		draw-out type		4-pole: 430x569x368		draw-out type		3-pole: 480x875x368		draw-out type		4-pole: 480x1005x368		draw-out type		4-pole: 480x1005x368													
Weight (kg)	fixed type		41	51	41	51	42	52	47	57	60	72	61	73	63	75	81	99	160	180	160	180	160	180	160	180	160	180	160	180	160	180	160	180														
	draw-out type		64	78	64	78	65	79	70	84	92	113	93	114	95	116	108	136	233	256	233	256	240	263	233	256	233	256	240	263	233	256	233	256														
	cradle only		26	30	26	30	26	30	31	35	35	43	35	43	36	44	49	61	118	133	118	133	125	140	118	133	118	133	125	140	118	133	118	133														

① Conforms to IEC60947-2, EN60947-2
 ② Number of mechanical operating cycles (on/off).
 ③ Optional

Product skeleton of accessories for SUPER AE series air circuit breakers

Mitsubishi Electric offers a wide range of accessories for the Air Circuit Breakers to serve almost all variations of applications.

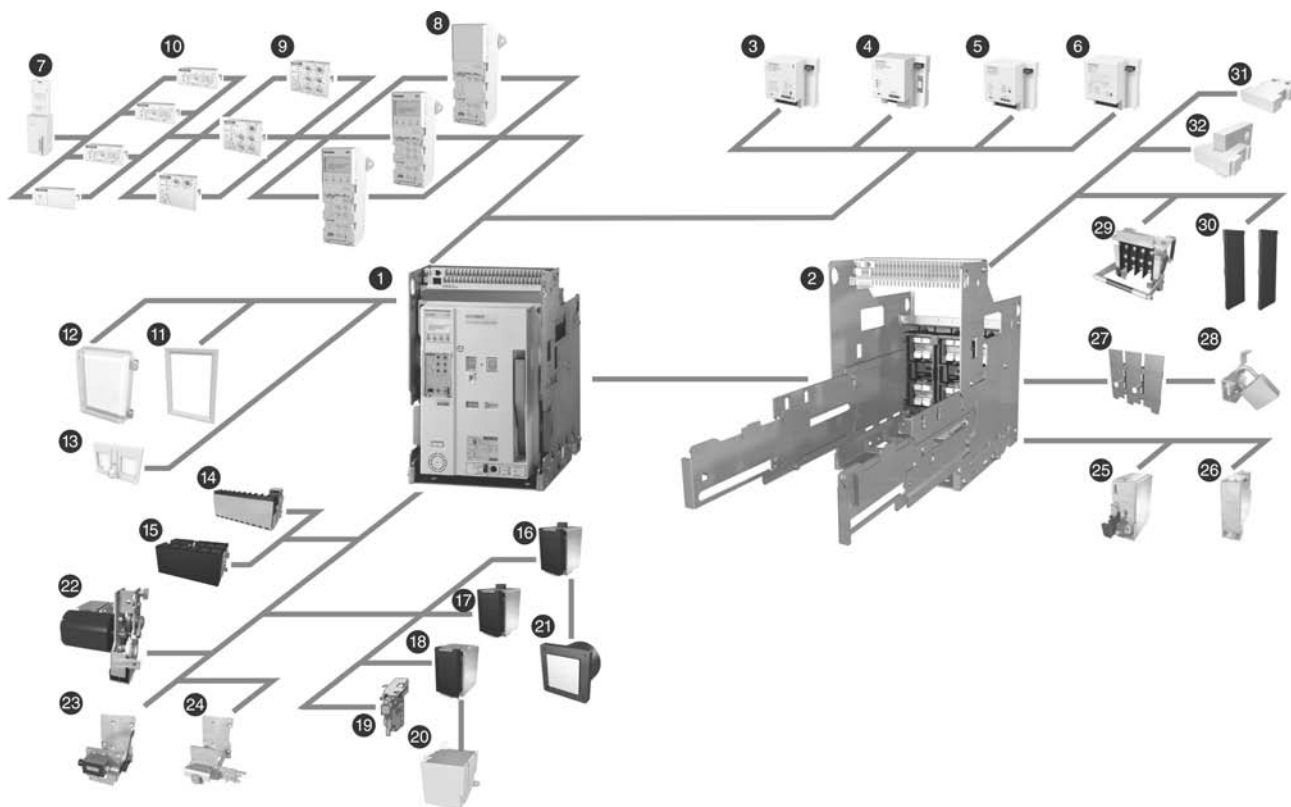

Position	Name
1	Air circuit breaker
2	Cradle
3	CC-Link® Interface unit
4	Profibus DP interface unit
5	Modbus® Interface unit
6	I/O unit
7	Extension module
8	ETR unit
9	Main setting module
10	Optional setting module
11	Door frame (DF)
12	Dust cover (DUC)

Position	Name
13	Push button cover (BC-L)
14	Auxiliary switch standard (AX)
15	Auxiliary switch high capacity type (HAX)
16	Shunt trip device (SHT)
17	Closing coil (CC)
18	Under voltage trip device (UVT)
19	Trip coil
20	UVT-controller (U-CON)
21	Condenser trip device (COT)
22	Motor charging device (MD)
23	Counter (CNT)
24	Cylinder lock (CYL)

Position	Name
25	Door interlock (DI)
26	Mechanical interlock (MI)
27	Safety shutters (SST)
28	Safety shutter lock (SST-LOCK)
29	Cell switch (CL)
30	Interphase Barrier (BA)
31	Horizontal terminal
32	Vertical terminal

For details on our full range including accessories contact your local distributor

WS series moulded-case circuit breakers

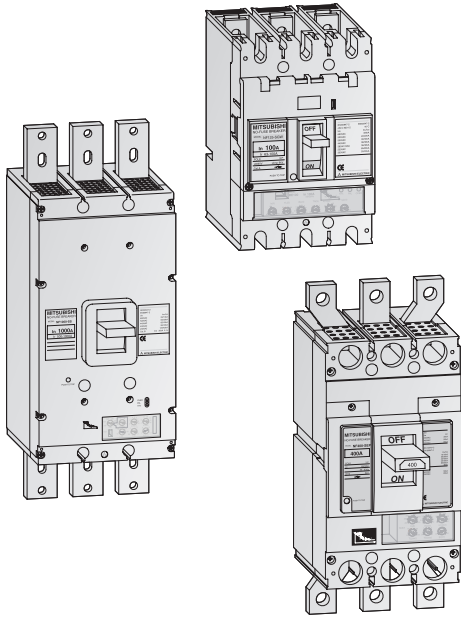

The moulded-case circuit breakers of the Mitsubishi Electric breaker series are amongst the smallest compact circuit breakers in the world with electronic overload indication of this kind. The system is based, among other things, on the well-known and proven microprocessor technology.

WSS – World Super Series

The new WSS breaker series meets national and international protection ratings according to VDE, EN, and IEC standards for industrial applications as well as for extended shipping demands.

The new tripping technology guarantees a high reliability and highest protection.

- 16 A to 250 A in one model size (3- and 4-pole)
- Overcurrent tripping relay unit (thermal type or electronic type)
- Available in fixed and plug-in versions
- Breaking capacity up to 200 kA

Specifications

Specifications		NF32-SV	NF63-SV	NF63-HV	NF125-SGV	NF125-SEV	NF125-LGV
Rated current $I_{n,max}$ [A]		32	63	63	125	125	125
Rated insulation voltage U_i [V]	AC	600	600	690	690	690	690
Number of poles		3	3/4	3/4	3/4	3/4	3/4
Rated breaking capacity [kA] (I_{ca}/I_{cs})	IEC 947-2	—	—	2.5/2.5	8/8	8/8	8/8
	EN 60 947-2	690 V	—	10/8	36/36	36/36	50/50
	VDE 0660	440 V	2.5/2.5	7.5/7.5	10/8	36/36	50/50
Dimensions (WxHxD)	mm	75x130x68	75/100x130x68	75/100x130x68	105/140x165x68	105/140x165x68	105/140x165x68

Specifications		NF125-HGV	NF125-HEV	NF125-RGV	NF125-UGV	NF160-SGV	NF160-LGV	NF160-HGV
Rated current $I_{n,max}$ [A]		125	125	125	125	160	160	160
Rated insulation voltage U_i [V]	AC	690	690	690	690	690	690	690
Number of poles		3/4	3/4	3	3/4	3/4	3/4	3/4
Rated breaking capacity [kA] (I_{ca}/I_{cs})	IEC 947-2	690 V	10/8	10/8	—	15/15	8/8	8/8
	EN 60 947-2	440 V	65/65	65/65	125/125	200/200	36/36	50/50
	VDE 0660	400 V	75/75	75/75	150/150	200/200	36/36	50/50
Dimensions (WxHxD)	mm	105/140x165x68	105/140x165x68	105x165x68	105/140x240x68	105/140x165x68	105/140x165x68	105/140x165x68

Specifications		NF250-SGV	NF250-SEV	NF250-LGV	NF250-HGV	NF250-HEV	NF250-RGV	NF250-UGV
Rated current $I_{n,max}$ [A]		250	250	250	250	250	250	250
Rated insulation voltage U_i [V]	AC	690	690	690	690	690	690	690
Number of poles		3/4	3/4	3/4	3/4	3/4	3	3/4
Rated breaking capacity [kA] (I_{ca}/I_{cs})	IEC 947-2	690 V	8/8	8/8	10/8	10/8	—	15/15
	EN 60 947-2	440 V	36/36	36/36	50/50	65/65	125/125	200/200
	VDE 0660	400 V	36/36	36/36	50/50	75/75	150/150	200/200
Dimensions (WxHxD)	mm	105/140x165x68	105/140x165x68	105/140x165x68	105/140x165x68	105/140x165x68	105x165x68	105/140x240x68

Specifications		NF400-SEW	NF400-HEW	NF400-REW	NF630-SEW	NF630-HEW	NF630-REW	NF800-SEW	NF800-HEW	NF800-REW
Rated current $I_{n,max}$ [A]		400	400	400	630	630	630	800	800	800
Rated insulation voltage U_i [V]	AC	690	690	690	690	690	690	690	690	690
Number of poles		3/4	3/4	3	3/4	3/4	3	3/4	3/4	3
Rated breaking capacity [kA] (I_{ca}/I_{cs})	IEC 947-2	690 V	10/10	35/18	—	10/10	15/15	—	10/10	15/15
	EN 60 947-2	440 V	42/42	65/65	125/63	42/42	65/65	125/63	42/42	65/65
	VDE 0660	400 V	50/50	70/70	125/63	50/50	70/70	125/63	50/50	70/70
Dimensions (WxHxD)	mm	140/185x257x103	140/185x257x103	140x257x103	140/185x257x103	140/185x257x103	140x257x103	210/280x275x103	210/280x275x103	210x275x103

Specifications		NF1000-SEW	NF1250-SEW	NF1600-SEW
Rated current $I_{n,max}$ [A]		1000	1250	1600
Rated insulation voltage U_i [V]	AC	690	690	690
Number of poles		3/4	3/4	3/4
Rated breaking capacity [kA] (I_{ca}/I_{cs})	IEC 947-2	690 V	25/13	25/13
	EN 60 947-2	440 V	85/43	85/43
	VDE 0660	400 V	85/43	85/43
Dimensions (WxHxD)	mm	210/280x406x140	210/280x406x140	210/280x406x140

WS-V series up to 250 A available from october 2013

Product skeleton of accessories for moulded case circuit breakers

Mitsubishi Electric offers a wide range of accessories for the Moulded Case Circuit Breakers and disconnectors to serve almost all variations of applications.

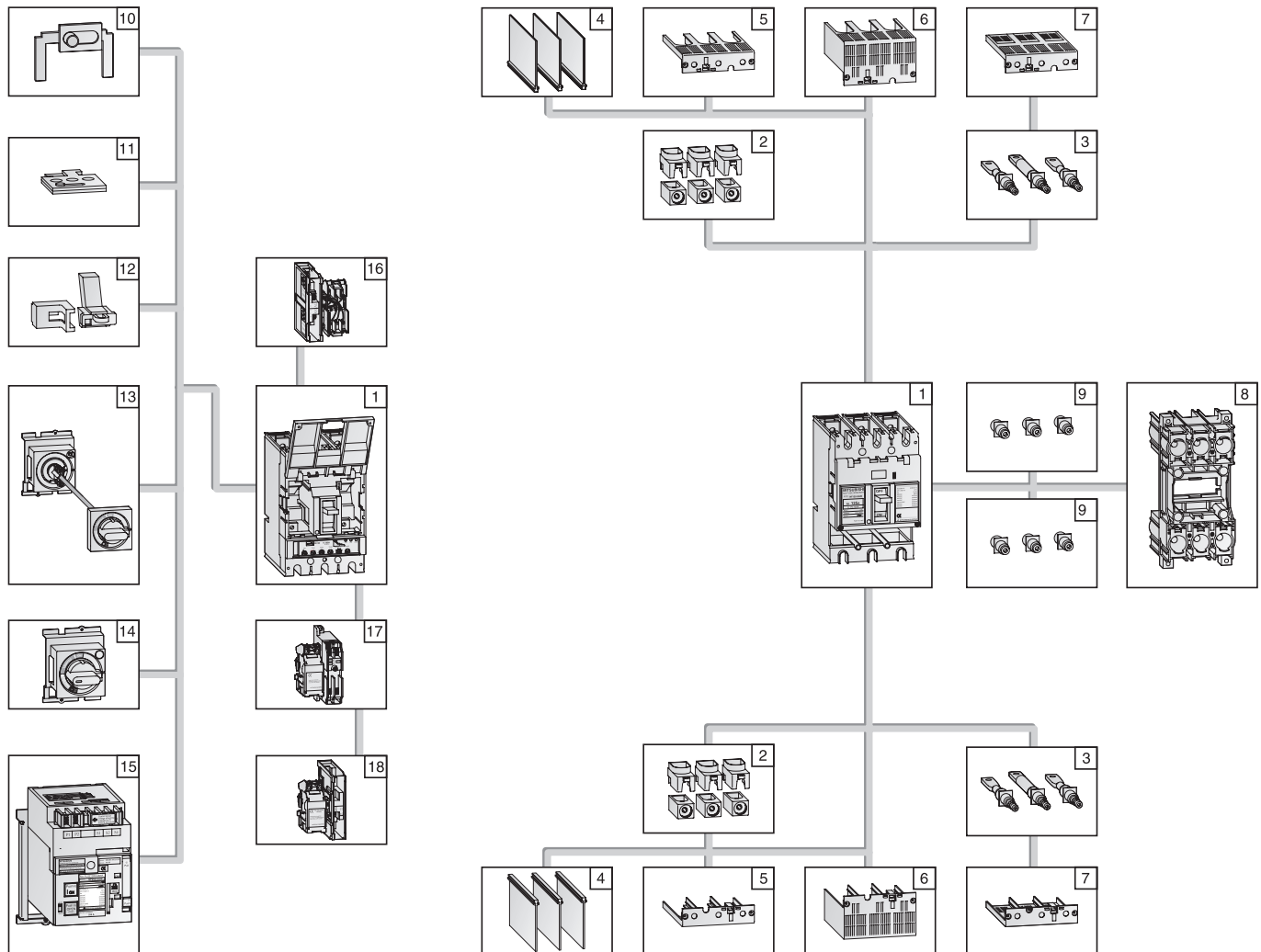

Position	Name	Description
1	Circuit Breaker	Main breaker unit.
2	Solderless (box) terminals	Connection accessories, only available for frame sizes 125/160/250 A.
3	Rear connection studs	Used for rear connection.
4	Insulating barriers (BA-F)	Used to avoid short-circuits between the terminals, every breaker is equipped with insulating barriers as standard.
5	Small terminal covers (TC-S)	Used to avoid exposure of charged parts, small type.
6	Large terminal covers (TC-L)	Used to avoid exposure of charged parts, large type.
7	Rear terminal covers (BTC)	Used to avoid exposure of charged parts, for rear connection.
8	Plug-in base (PM)	Used for easy connection and exchange.
9	Connections for Plug-in	Special connection accessories for Plug-in base.
10	Mechanical interlock (MI)	With two breakers, use a panel-mounted mechanical interlock for one-way only input. It is usable for front, rear, and plug-in types.
11	OFF Lock with 3 padlocks (HL)	Can be used to lock the handle of the breaker against switching OFF by not-allowed persons. Up to three padlock can be used.
12	Handle lock device (LC, HLF, HLN, HLS)	Can be used to lock the handle of the breaker against switching by not-allowed persons. Up to three padlock can be used.
13	Variable-depth operating handle, V type	The V-type operating handle is used to operate the breaker which is installed in a cabinet.
14	Rotary operating handle, R type	The R-type operating handle is to be mounted directly on the breaker.
15	Electrical operating device (MDS)	Used to switch the breaker ON and OFF electrically by remote.
16	Alarm and Auxiliary switches (AL, AX)	Indicators for status signals (ON, OFF, Tripped).
17	Under voltage trip device (UVT)	Trips the breaker when voltage drops.
18	Shunt trip device (SHT)	Trips the breaker by remote.

For details on our full range including accessories contact your local distributor

General purpose contactors

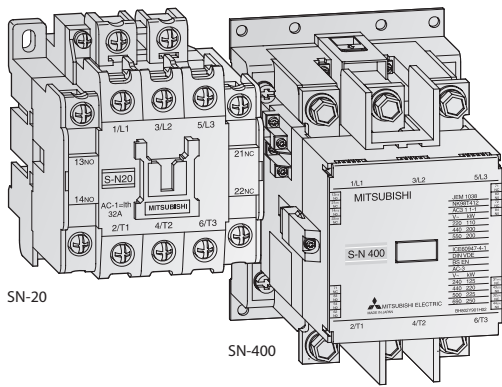

Compact, modular extensions and an energy-saving design – these are the main requirements set by users of contactors and auxiliary contactors.

Requirements that the MS-N series from Mitsubishi Electric fulfill.

Special features:

- Easy mounting and wiring
- Easy inspection
- Built-in surge absorber (from S-N50)

- Safety and speedy terminal functions
- Thermo-plastic improves the barrier strength
- Coil boasts lower coil consumption
- Improvement of Electromagnet (DC electromagnet with AC operation)
- Less noise nor surge from coil
- Conform to IEC947-4-1, EN-Standards
- Wide range for rated continuous current I_{th} from 20 A to 1000 A

Handling of the contactors

S-N10CX to S-N65CX units can all be mounted on DIN rail (35 mm wide).

A variety of auxiliary blocks and optional features are available including:

- Standard front clip-on auxiliary contact blocks (4-pole-type and 2-pole-type)
- Low-level signal front-clip-on auxiliary contact blocks

- Side clip-on auxiliary contact blocks
- Surge absorbers (varistor and CR models)
- Surge absorbers with LED operating indicators
- Mechanical interlocks

Compact arc quenching and magnet layout greatly reduces installation space.

The coil rating is displayed in a location readily visible even after the unit is installed onto the panel.

Contacts are visible when the cover is removed, allowing them to be checked easily.

Three-phase motor ratings IEC category AC3 for Contactors

Contactor	AC-operated	S-N10CX	S-N11CX	S-N12CX	S-N18CX	S-N20CX	S-N21CX	S-N25CX	S-N35CX	S-N50CX	S-N65CX
	DC-operated	—	SD-N11CX	SD-N12CX	—	—	SD-N21CX	—	SD-N35CX	SD-N50	SD-N65
AC 380–440 V	kW	4	5.5	5.5	7.5	11	11	15	18.5	22	30
Rated continuous current I_{th}	A	20	20	20	25	32	32	50	60	80	100
Auxiliary contacts (standard)		1 NO or 1 NC	1 NO or 1 NC	1 NO + 1 NC	—	1 NO + 1 NC	2 NO + 2 NC	2 NO + 2 NC	2 NO + 2 NC	2 NO + 2 NC	2 NO + 2 NC



Thermal Overload Relays

Type	TH-N12KPCX	TH-N18KPCX	TH-N20KPCX	TH-N20TAKPCX	TH-N60KPCX
Setting range	0.1–13 A	1–18 A	0.2–22 A	18–40 A	12–65 A

Three-phase motor ratings IEC category AC3 for Contactors

Contactor	AC-operated	S-N80	S-N95	S-N125	S-N150	S-N180	S-N220	S-N300	S-N400	S-N600	S-N800
	DC-operated	SD-N80	SD-N95	SD-N125	SD-N150	—	SD-N220	SD-N300	SD-N400	SD-N600	SD-N800
AC 380–440 V	kW	45	55	60	75	90	132	160	220	330	440
Rated continuous current I_{th}	A	135	150	150	200	260	260	350	450	800	1000
Auxiliary contacts (standard)		2 NO + 2 NC	2 NO + 2 NC	2 NO + 2 NC	2 NO + 2 NC	2 NO + 2 NC	2 NO + 2 NC	2 NO + 2 NC	2 NO + 2 NC	2 NO + 2 NC	2 NO + 2 NC



Thermal Overload Relays

Type	TH-N60TAKP	TH-N120KP	TH-N120TAKP	TH-N220RHKP	TH-N400RHKP	TH-N600KP
Setting range	54–105 A	34–100 A	85–150 A	65–250 A	85–400 A	200–800 A

Thermal overload relays

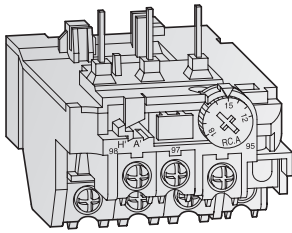

TH-N18KPCX

A selection of relays for optimum motor protection characteristics

The thermal relay line-up includes the phase failure protection type models (three-element relays).

This array of protection characteristics allows you to choose the units suited to your motor protection needs.

- An operation indicator makes maintenance and inspection easy.
- 1 NO and 1 NC contact
- Rated current can be set easily
- Finger protection up to TH-N60KPCX
- Trip-free reset bar
- Convenient reset release (optional)

Contactor relays

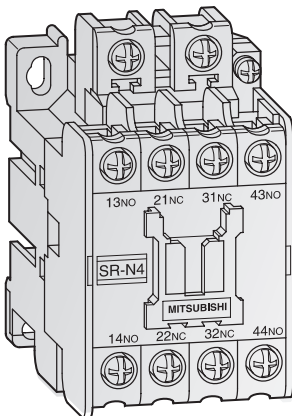

SR-N4

Contactor relays are designed for use in low voltage control circuit applications.

Our standard contactor relay version is with 4 auxiliary contacts.

With side clip-on and front clip-on configurations available, a maximum of 8 auxiliary contacts are possible.

- High reliability: By adopting bifurcated moving contacts and by improving the shape of the contacts, contact performance has been made more reliable than ever.
- Different types: Standard, large capacity, overlap contact

- Various contact arrangement and long life
- Mountable on 35 mm DIN rails
- Dust-proof construction
- Easily visible coil ratings
- Easy wiring (self-rising terminal screws)
- Various accessories common with the series S-N contactors (front and side clip-on type additional auxiliary contact blocks, surge absorbers)
- Finger protected types are available (DIN 57106/VDE 0106 Part 100) (Suffix "CX")

Contactor Relays

Contactor Relays	SR-N4CX 4A	SR-N4CX 3A1B	SR-N4CX 2A2B
AC-operated type	SR-N4CX 4A	SR-N4CX 3A1B	SR-N4CX 2A2B
DC-operated type	SRD-N4CX 4A	SRD-N4CX 3A1B	SRD-N4CX 2A2B
Auxiliary contacts	4 NO	3 NO, 1 NC	2 NO, 2 NC

Product skeleton of accessories for magnetic contactors, thermal overload relays & contactor relays

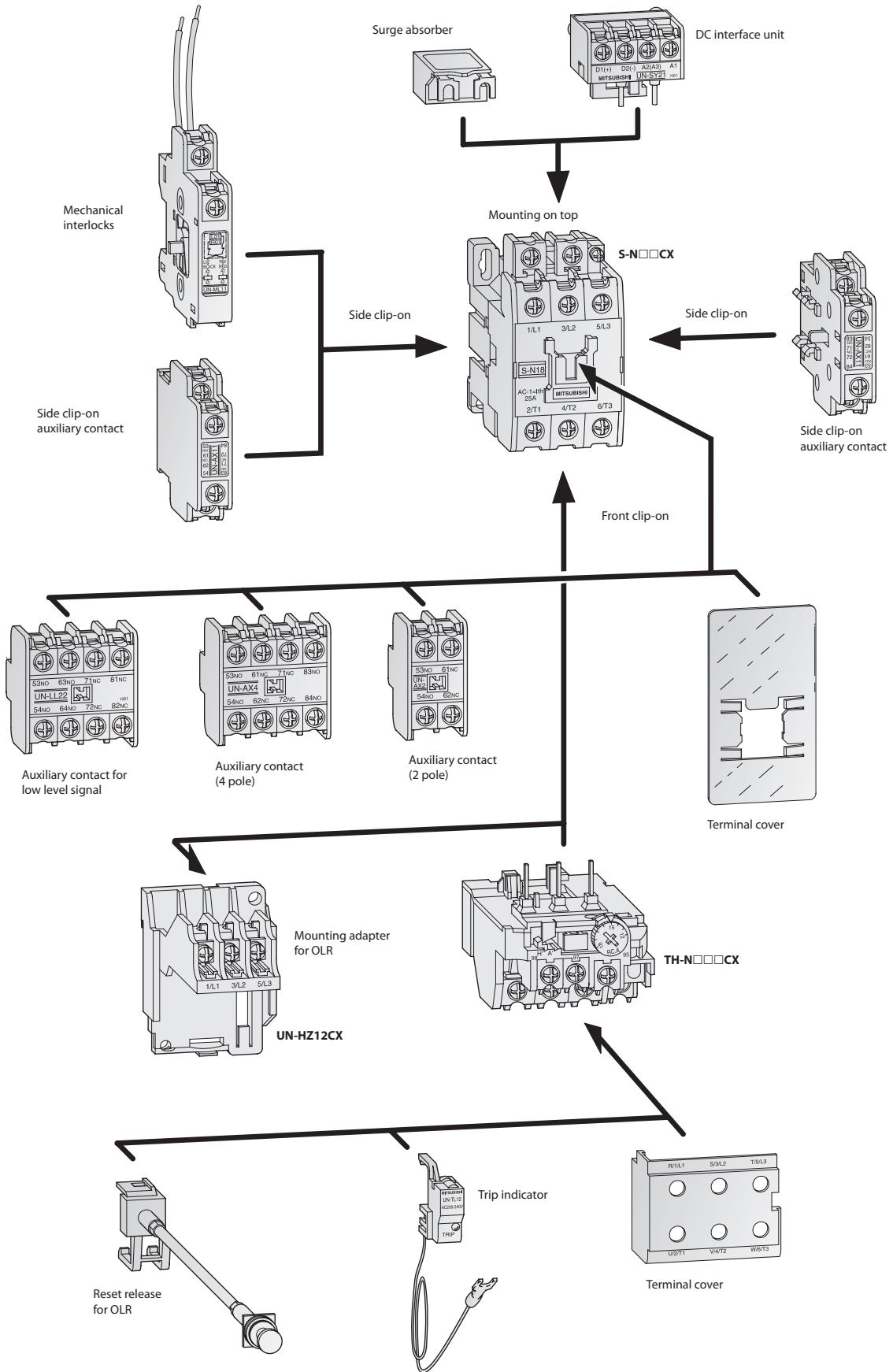

10

Low Voltage Switch Gears

Electronic multi-measuring instruments

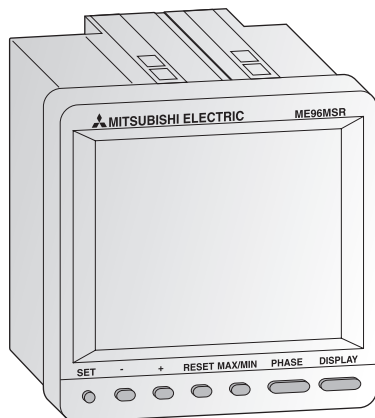

ME96NSR

The ME96NSR measures and displays all important values of a low voltage/medium voltage power distribution system. By optional plug-in modules, remote I/O's and open network communication can be added. The remote I/O will be used for monitoring the MCCB or ACB status or can be used for energy counters. It provides full integration in a CC-Link or Modbus network and allows therefore energy reduction and optimization controlled by a PLC.

- Compact sizes according to DIN
- Easy to read display and simple to learn operation
- Flexible to use and modular
- expandable
- Conforms to CE standard

Specifications	ME96NSR	ME96NSR-MB	
Display	LCD, monochrome	LCD, monochrome	
Function keys	7	7	
Memory for	Measurements and settings		
Network connection	—	RS485/Modbus	
Expandability	CC-Link, digital or analog I/Os via plug-in module		
External power supply	100 to 240 V AC (+10 %, -15 %), 50/60 Hz; 75–140 V DC		
Operating conditions	-5–50 °C (average temperature; ≤35 °C per day), 30–85 % humidity (no condensation)		
Storage conditions	-20–60 °C		
Dimensions (BxHxT)	mm 96x96x86	96x96x86	
Weight	kg 0.5	0.5	
Standards	EMC: EN61326-1:2006 safety standard: EN61010-1:2001		
Order information	Art. no.	221596	221597

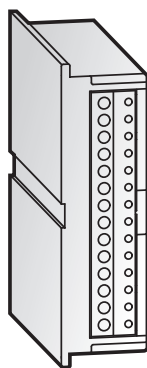

Plug-in modules

Using an optional plug-in module the multi-measuring instrument can be connected in open CC-Link networks. They offer different I/Os to display measured data from the electric distribution system or similar.

The plug-in module can be simply plugged into the designated space on the back side of the measuring module.

Specifications	ME-4201-NS96	ME-0040C-NS96	ME-0052-NS96	
Analog outputs	4	—	—	
Pulse outputs	2	—	—	
Potential free inputs	—	4	5	
Potential free outputs	1	—	2	
Network connection	—	CC-Link	—	
Suitable measuring instrument	ME96NSR	ME96NSR	ME96NSR-MB	
Order information	Art. no.	221598	221599	221600

Measured and displayed can be:

- Measuring of voltage, current, active power, reactive power, apparent power, power factor, and frequency.
- In addition, total of six types of energy (incoming energy, outgoing energy, incoming lag reactive energy, incoming lead reactive energy, outgoing lag reactive energy, and outgoing lead reactive energy) can be measured.
- Using the RS485 interface monitoring of contact input (5 circuits) and power monitoring of output control (2 circuits) can be operated at the same time.
- Status of the breaker (e. g. ON, OFF, tripped, alarm; only useable with AE-SW)
- Measuring of imported and exported energy
- Measuring ranges: IT and TN, 60 V to 750 kV, 5 A to 30 kA, 50 to 60 Hz

Effectively optimizing production by directly connecting enterprise systems with the shop floor.

MES Solutions The MES interface product group enables direct connection between the MES (Manufacturing Execution System) database and shop floor equipment, without a communication gateway such as a PC.

The MES benefits are:

- accurate information in real-time through direct utilization of internal device information
- simple system implementation by direct connecting to database(s)
- no need for PCs and programs, which greatly reduces costs
- improved reliability by changing the gateway PC to a PLC
- no specialists and expensive interfacing software needed
- reduced installation costs
- reduced network load because of trigger executed database communication and not polling data

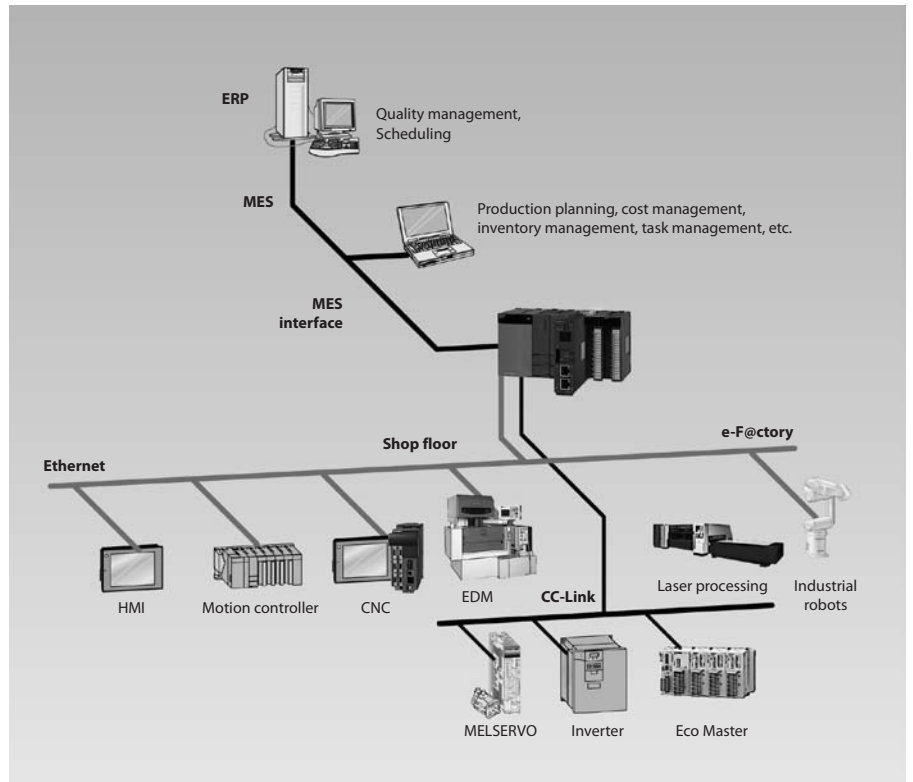

MELSEC System Q MES Interface IT module

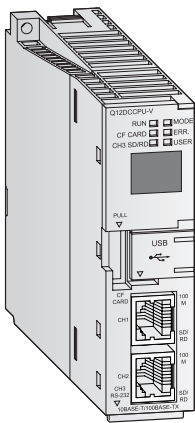

The MES Interface IT module provides a direct link from the iQ Platform to enterprise IT systems. Hence any shop floor system using the iQ Platform can communicate directly with high level IT systems. This allows the removal of the

usual intermediate layer of PC infrastructure required to process shop floor data. This saves cost, increases security and reduces maintenance requirements.

Specifications	MESIT	
Module type	MES interface IT modul	
Communications method	Ethernet	
Interface	type 10BASE-T/100BASE-TX	
DB interface function	general databases	Interacts with databases via user-defined jobs (Windows, Linux, Unix ect)
	SQL commands	Oracle®/SAP, Microsoft® SQL, DB2, DB2/400
	messaging	Http, E-mail, TCP, IBM WebSphere MQ, MQTT, JBOSS
	trigger buffering function	The MES module buffers the data and trigger time to internal memory.
	arithmetic processing	Formulas can be applied to data before sending from the MES interface module.
	program execution function	Executes programs in the application server computer
Memory capacity	1 CompactFlash Card can be installed	
Internal power consumption (5 V DC)	mA 0.93	
Dimensions (WxHxD)	mm 27.4x98x115	

Order information	Art. no.	
		MES-IT module Hardware: 134930
		Core Software incl. Mitsubishi Electric driver and 5 connections to PLC 227387
		Database Connection for SQL 227390
		Database Connection for Oracle 227391
		Database Connection for DB2 227392
		Additional 5 PLC connections 227388
		Siemens driver for S7-200, 300, 400, 12000 229481
		Mitsubishi Electric MC Protocol driver 231543
		Modbus driver 231544
		Rockwell driver 227395
		Omron driver 227397

MELSEC System Q MES Interface module

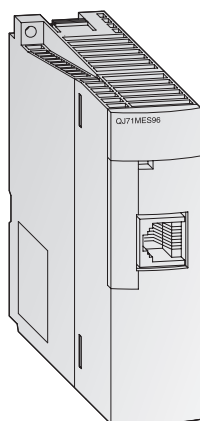

QJ71MES96

The MELSEC System Q MES module allows users to interface their production control systems directly to a MES database based on Windows technology.

Specifications		QJ71MES96
Module type		MES interface module
Communications method		Ethernet
Interface	type	10BASE-T/100BASE-TX
DB interface function	general	Interacts with databases via user-defined jobs
	tag function	Collects device data of the PLCs CPU on the network in units of tags.
	trigger monitor function	Monitors the status of conditions (time, tag values, etc.)
	trigger buffering function	The MES module buffers the data and trigger time to internal memory.
	SQL text transmission	Automatically generates the correct SQL message according to requirements.
	arithmetic processing	Formulas can be applied to data before sending from the MES interface module.
	program execution function	Executes programs in the application server computer
Memory capacity		1 CompactFlash Card can be installed
I/O points		32
Internal power consumption (5 V DC)	mA	650
Dimensions (WxHxD)	mm	27.5x98x90
Order information		Art. no. 200698

MES option board for GOT (GT15 and GT16 series)

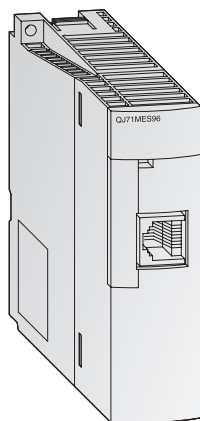

GT15-MESB-48M and GT16M-MESB

By using an MES option card the GT15 and GT16 are able to communicate directly with Windows databases without needing a Gateway-PC.

Specifications		GT15-MESB48M	GT16M-MESB
Module type		GT15 option card with 48 MB expansion memory and MES functionality (for direct database connection)	GT16 option card with MES functionality (for direct database connection)
DB interface function	general	Interacts with databases via user-defined jobs	
	tag function	Collects device data of the PLCs CPU on the network in units of tags.	
	trigger monitor function	Monitors the status of conditions (time, tag values, etc.)	
	trigger buffering function	The MES module buffers the data and trigger time to internal memory.	
	SQL text transmission	Automatically generates the correct SQL message according to requirements.	
	arithmetic processing	Formulas can be applied to data before sending from the MES interface module.	
	program execution function	Executes programs in the application server computer	
Order information		Art. no. 203473	221369

For GT15 the additional Ethernet communication module GT15-J71E71-100 is required.
For GT15 and GT16 a standard CF card up to 2 GB is required

The information collected on the MELSEC System Q PLC is linked by the PLC MES interface module, and the information from existing equipment and 3rd party controllers is linked by the GOT1000 MES interface function.

The MES interface product series links shop floor equipment and MES information simply, with minimum cost.

Power supply modules

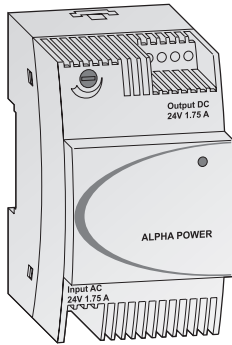

The ALPHA POWERS are convenient power supplies for the 24 V units and other external devices. They are applicable for wall or DIN rail mounting and their dimensions are matched to those of the Alpha family.

Up to 5 Alpha Power units can be installed together for redundant mode operation or connected in parallel for more power.

The units have an integrated thermal overload protection circuit and a POWER LED. The output voltage is adjustable.

Specifications	ALPHA POWER 24-0.75	ALPHA POWER 24-1.75	ALPHA POWER 24-2.5
Application	Power supply for the 24 V ALPHA base units and external devices		
Nominal input voltage	100–240 V AC (45–65 Hz)		
Output voltage	24 V DC (+/-1 %)		
Max. output current	0.75 A	1.75 A	2.5 A
Protection	IP20		
Dimensions (WxHxD)	mm 36x90x61	54x90x61	72x90x61
Order information	Art. no. 209029	209030	209031

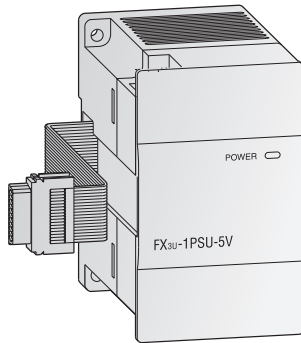

The power supply modules FX3U-1PSU-5V and FX3UC-1PS-5V are used to reinforce the build-in 5 V DC and 24 V DC power supply of a FX3U/ FX3UC main unit. They do not occupy any I/O points and deliver up to 1 A more current for the 5 V system bus (for special function modules).

Two FX3U-1PSU-5V units can be installed in parallel for more power.

Specifications	FX3U-1PSU-5V	FX3UC-1PS-5V
Application	Power supply for the FX3U system bus	Power supply for the FX3UC system bus
Nominal input voltage	100–240 V AC (50/60 Hz)	24 V DC (+20 %/-15 %)
Output voltage	5 V DC/24 V DC	5 V DC
Max. output current	5 V DC: 1 A at 40 °C; 0.8 A at 55 °C 24 V DC: 0.3 A at 40 °C; 0.2 A at 55 °C	1 A
Dimensions (WxHxD)	mm 55x90x87	24x90x74
Order information	Art. no. 169507	210086

Note: The FX3U-1PSU-5V can't be used with a 24 V base unit!

When connecting an input extension module (e.g. FX2N-8ER-ES/UL, FX2N-8ER) to the FX3U-1PSU-5V, supply the power for it from the 24 V DC service power supply of the connected main unit or powered extension unit on the upstream side.

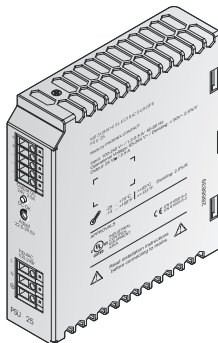

The primary switched-mode power supply units PSU are especially applicable for universal usage in batch mechanical engineering. The wide range input and the UL, cUL certifications allow a worldwide application. The 3-phase units supply the full permanent output power at breakdown of one phase.

The power supply units can be installed in parallel for more power or for redundant mode operation.

The units dispose of an adjustable output voltage, a thermal overload protection circuit and a POWER LED.

Specifications	PSU 25	PSU 50	PSU 100	PSU 200	PSU 200-3	PSU 400-3
Application	Power supply for all peripheral devices					
Nominal input voltage	100–240 V AC (45–65 Hz)				380–400 V AC	
Output voltage	24 V DC					
Max. output current	2.5 A	5 A	10 A	20 A	20 A	40 A
Protection	IP20					
Dimensions (WxHxD)	mm 32x130x115	40x130x115	60x130x152.5	115x130x152.5	115x130x152.5	139x130x190
Order information	Art. no. 206147	206148	206149	208850	208851	208852
Accessories (PSU 100 or larger)	Wall mounting adapter PSU-UWA, art. no.: 208853					

Compact PLCs			
Active data modules	86		
Analog I/O adapters	80		
Analog modules	79		
Analog temperature input adapters	80		
Analog temperature input modules	80		
Calculation of the power consumption	72		
CC-Link master and slave modules	84		
Communication adapter board	87		
Communications adapter	87		
Control and display panel	88		
Data logger module	81		
Digital and analog extension adapters	87		
Display modules	88		
Equipment features	70		
Expandability and functionality	78		
Expandability and power	70		
FX1S series	73		
FX3GC series	75		
FX3GE series	75		
FX3G series	74		
FX3UC series	77		
FX3U series	76		
High speed counter and pulse train modules	82		
Interface adapters	86		
Master and slave modules for Profibus DP	83		
Memory cassettes	88		
Micro controllers Alpha series	70		
Network module for CANopen	85		
Network module for Ethernet	84		
Network module for J1939	85		
Positioning modules	82		
Power supply modules	87		
Remote I/O station	83		
SSCNETIII module	82		
Temperature control module	81		
The ALPHA 2 series	89		
What components are required for an FX PLC system?	71		
Frequency Inverters			
EMC filter and electromagnetic compatibility	118		
FR-A700	108		
FR-D700 SC	104		
FR-E700 SC	105		
FR-F700	106		
General operating conditions for all inverters	112		
Intelligent technology	103		
Internal and external options	113		
Overview noise filters	116		
Human Machine Interfaces			
Control units	92		
E series	99		
GOT series	93		
Interface adapters and cables	101		
Main ranges	91		
Low Voltage Switch Gears			
Electronic multi-measuring instruments	161		
General purpose contactors	158		
Relays	159		
SUPER AE series	154		
The complete solution	153		
WS series	156		
MELFA Robot Systems			
F-D and F-Q series	150		
Options overview	152		
Powerful controller	149		
Practical functions for all applications	144		
RH-3SDHR/SQHR	147		
RH-FH	148		
Robots teach panel	151		
RP series	147		
RV-2FB	145		
RV-4FLM	145		
RV-7FM/RV-7FLM	146		
RV-12SD/RV-12SQ/RV-12SDL/RV-12SQL	146		
MES Solutions			
MES option board	163		
Optimizing production	162		
System Q MES Interface IT module	162		
System Q MES Interface module	163		
Mitsubishi Electric on the Web	166		
Modular PLCs			
Accessories	55		
Analog CT Input Module	45		
Analog input modules	42		
Analog modules for temperature measurement	46		
Analog output modules	43		
Base units	32		
Combined analog input/output module	44		
Digital input modules	39		
Digital output modules	40		
Equipment features	30		
High-speed counter modules	48		
High speed data logger module	51		
Interface module	52		
Interrupt module and high-speed inputs	52		
iQ Platform	30		
Load cell input module	47		
Loop control module	48		
MELSEC Safety PLC	53		
Motion CPU modules	37		
Multi-function counter/timer module	51		
NAMUR input module	41		
PC CPU Module	38		
PLC CPU modules	34		
Power supply modules	33		
Process CPU modules	36		
Q-C Controller CPU	37		
Redundant PLC CPU modules	36		
System Q MES interface module	50		
System Q power measurement module	49		
System Q voltage converter	50		
System Q web server module	49		
Temperature control modules	47		
What a system looks like	31		
What you need	31		
Modular PLCs MELSEC L series			
Accessories	69		
Analog input modules	63		
Analog output modules	63		
Branch/Extension Module	68		
Built-in I/O features	57		
CC-Link/CC-Link IE Field modules	66		
CPU modules	59		
Digital input modules	60		
Digital output modules	61		
End cover	68		
Equipment features	57		
Ethernet modul	67		
High-speed counter modules	65		
Interface modules	65		
IO-Link Module	62		
Power supply modules	59		
Serial communications adapters	68		
Temperature Control Modules	64		
What a system looks like	58		
What you need	58		
Networks			
AS-Interface	15		
CANopen	17		
CC-Link, CC-Link IE, CC-Link IE Field and CC-Link Safety	12		
DeviceNet	15		
Ethernet	11		
MELSECNET/H	16		
Modbus	17		
Profibus DP	14		
Profinet	14		
SSCNETIII	16		
Typical Distributed Control Structure	11		
Web Server	13		
Power supplies	164		
Remote I/O Modules			
Analog I/O modules	23		
CC-Link/CC-Link IE Field remote modules	18		
Data exchange with peripherals	19		
Digital I/O modules	22		
High-speed counter	19		
Open control loop positioning	19		
Special function modules	24		
The MELSEC STlite series scalable I/O solutions for CC-Link, Profibus and Ethernet	20		
The MELSEC ST series – premium product for process industry	26		
Servo and Motion Systems			
Dimensions	127		
General overview	119		
MR-ES	133		
MR-J3-D05	137		
MR-J4 (200/400 V type)	134		
MR-J4W2-B/MR-J4W3-B	136		
MR-MQ100	140		
Positioning modules	138		
Q170MSCPU/Q170MPCPU-S1	141		
Servo motor features and typical applications	124		
Servo motors overview	125		
Simple Motion module	142		
System configuration	122		
System Q-Motion CPU	143		
System Q-Motion system modules	143		
X-Y table system configurations	123		
Software			
HMI Programming	5		
E Designer	5		
GT Works3	5		
iQ Works	4		
Life Cycle Engineering Software	9		
MAPS – Mitsubishi Adroit Process Suite	9		
PC Data Management	8		
MX Component	9		
MX OPC Server	8		
MX Sheet	8		
PLC Programming	6		
Alpha – ALVLS (AL-PCS/WIN)	6		
GX Configurator DP	6		
GX Configurator PN	6		
GX Works2/GX Works2 FX	6		
Robots programming	7		
RT ToolBox2	7		
Servo/Motion programming	7		
FX Configurator FP	7		
MR Configurator2	7		
MT Works2	7		
Soft HMI	5		
GT Works3 (GT SoftGOT1000)	5		
Special applications	8		
FR Configurator	8		
Visualisation Software	5		

The Mitsubishi Electric Industrial Automation internet portal

The Mitsubishi Electric Automation website

Our website provides a simple and fast way of accessing further technical data and up to the minute details on our products and services. Manuals and catalogues are available in several different languages and can be downloaded for free. The main page is available under www.mitsubishi-automation.com. The web site is available in more than 10 different languages and the number of languages is still growing. Follow the drop down menu in the upper right corner of the web site to see if your language is already available.



The European Automation portal

MyMitsubishi gives you more

Are you interested in news about products and technologies from Mitsubishi Electric for factory and process automation applications? Do you need an address in your area for a local Mitsubishi Electric distributor? Or are you already a customer and need quick access to the latest technical information? You can already find all this and more on our website, but with MyMitsubishi you can find the information you need even faster and more easily and you also get some valuable additional services. Take advantage of MyMitsubishi – it's your direct channel to Mitsubishi Electric automation technology.

How to register

Click on the Register Now link on the MyMitsubishi page to display the registration form. Enter a user name and password of your choice and your contact details, then click on the Register button. Shortly after doing this you will receive an email asking you to confirm and complete the registration process. If you ever forget your password just click on the I forgot my password link to have it sent to your registered email address. You are in complete control of how we work with you. You can edit, modify or even delete your registration at any time from within your personal profile.

MyMitsubishi benefits at a glance

As a registered user you have free access to many useful additional services that are not available to the general public.

● Additional downloads

In addition to brochures, technical catalogues and manuals, MyMitsubishi members can also download the latest software updates and drivers, CAD, GSD and EDS files and copies of product certifications.



MyMitsubishi offers numerous free downloads.

● Graphics database

MyMitsubishi members also have access to our graphics database with product photos, graphics and illustrations from our brochures and catalogues.



Free access to the comprehensive graphics database.

● Newsletter

Stay up to date: Subscribers to our email newsletter don't miss any events or special promotions. Once a month you will receive the latest news from the world of Mitsubishi Electric automation technology. Topics include product news, case studies on applications realised with Mitsubishi Electric products in all fields of automation, trade show dates, events for customers and special offers.



Always up to date with the Mitsubishi Electric Newsletter.

● Further benefits

With MyMitsubishi you have the additional opportunity to use various online utilities such as tools for the selection or configuration of products. Furthermore, you get access to our extensive knowledge base and additional services such as the usage of a download list, the extended product warranty or the option to register your software.



Manage your own favorites list.

A world of automation solutions

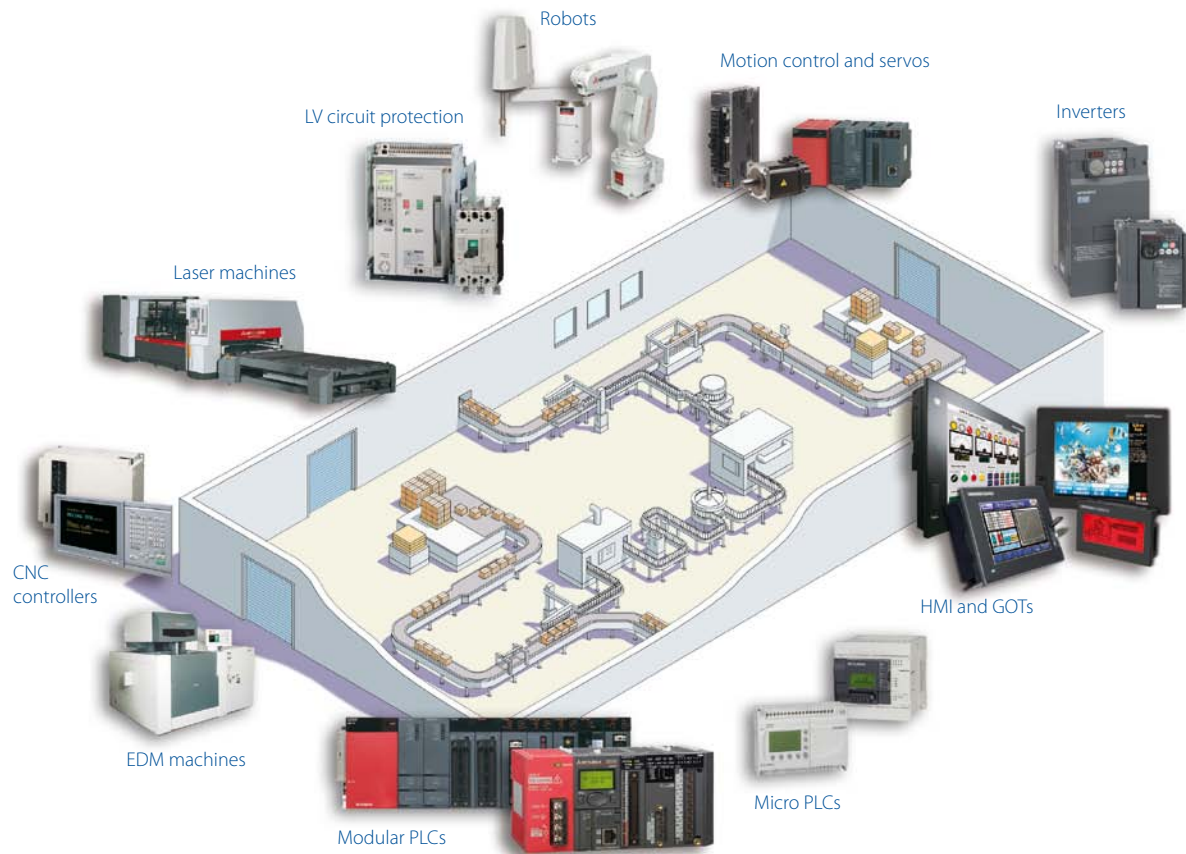

Mitsubishi Electric offers a wide range of automation equipment from PLCs and HMIs to CNC and EDM machines.

A name to trust

Since its beginnings in 1870, some 45 companies use the Mitsubishi name, covering a spectrum of finance, commerce and industry.

The Mitsubishi brand name is recognized around the world as a symbol of premium quality.

Mitsubishi Electric Corporation is active in space development, transportation, semiconductors, energy systems, communications and information processing, audio visual equipment, home electronics, building and energy management and automation systems, and has 237 factories and laboratories worldwide in over 121 countries.

This is why you can rely on a Mitsubishi Electric automation solution – because we know first hand about the need for reliable, efficient, easy-to-use automation and control in our own factories.

As one of the world's leading companies with a global turnover of over 4 trillion Yen (over \$40 billion), employing over 100,000 people, Mitsubishi Electric has the resource and the commitment to deliver the ultimate in service and support as well as the best products.

Global partner. Local friend.

European Offices

Mitsubishi Electric Europe B.V. Gothaer Straße 8 D-40880 Ratingen Phone: +49 (0)2102 / 486-0	Germany	Mitsubishi Electric Europe B.V. ul. Krakowska 50 PL-32-083 Balice Phone: +48 (0) 12 630 47 00	Poland
Mitsubishi Electric Europe B.V.-org.s.l. Radlická 751/113e Avenir Business Park CZ-158 00 Praha 5 Phone: +420 (0) 251 / 551 470	Czech Rep.	Mitsubishi Electric Europe B.V. 52. bld. 3 Kosmodamijskaya nab 8 floor RU-115054 Moscow Phone: +7 495 / 721 2070	Russia
Mitsubishi Electric Europe B.V. 25, Boulevard des Bouvets F-92741 Nanterre Cedex Phone: +33 (0)1 / 55 68 55 68	France	Mitsubishi Electric Europe B.V. Carretera de Rubí 76-80 Appdo. 420 E-08190 Sant Cugat del Valles (Barcelona) Phone: +34 (0) 93 / 5653131	Spain
Mitsubishi Electric Europe B.V. Viale Colleoni 7 Palazzo Sirio I-20864 Agrate Brianza (MB) Phone: +39 039 / 60 53 1	Italy	Mitsubishi Electric Türkiye Şerifali Mahallesi Nutuk Sokak No:5 TR-34775 Ümraniye-İSTANBUL Phone: +90 (0)216 / 526 39 90	Turkey
Mitsubishi Electric Europe B.V. Westgate Business Park, Ballymount IRL-Dublin 24 Phone: +353 (0)1 4198800	Ireland	Mitsubishi Electric Europe B.V. Travellers Lane UK-Hatfield, Herts. AL10 8XB Phone: +44 (0)1707 / 28 87 80	UK

Representatives

GEVA Wiener Straße 89 A-2500 Baden Phone: +43 (0)2252 / 85 55 20	Austria	Beijer Electronics A/S Lykiesgardsvej 17 DK-4000 Roskilde Phone: +45 (0)46 / 75 76 66	Denmark	Beijer Electronics UAB Goštautu g. 3 LT-48324 Kaunas Phone: +370 37 262707	Lithuania	INEA SR Izletnicka 10 SER-113000 Smederevo Phone: +381 (0)26 / 615 401	Serbia	I.C. SYSTEMS Ltd. 23 Al-Saad-Al-Alee St. EG-Sarayut, Maadi, Cairo Phone: +20 (0) 2 / 235 98 548	Egypt
OOO "TECHNIKON" Prospect Nezavisimosti 177-9 BY-220125 Minsk Phone: +375 (0)17 / 393 1177	Belarus	Beijer Electronics Eesti OÜ Pärnu mnt.160i EE-11317 Tallinn Phone: +372 (0)6 / 51 81 40	Estonia	ALFATRADE Ltd. 99, Paola Hill Malta-Paola PLA 1702 Phone: +356 (0)21 / 697 816	Malta	SIMAP s.r.o. Jána Derku 1671 SK-911 01 Trenčín Phone: +421 (0)32 743 0472	Slovakia	ILAN & GAVISH Ltd. 24 Shenkar St., Kiryat Arie IL-49001 Petah-Tikva Phone: +972 (0)3 / 922 18 24	Israel
ESCO DRIVES Culliganlaan 3 BE-1831 Diegem Phone: +32 (0)2 / 717 64 60	Belgium	Beijer Electronics OY Vanha Nurmijärventie 62 FIN-01670 Vantaa Phone: +358 (0)207 / 463 500	Finland	INTEHISIS SRL bld. Taian 23/1 MD-2060 Kishinev Phone: +373 (0)22 / 66 4242	Moldova	INEA RBT d.o.o. Stegne 11 SI-1000 Ljubljana Phone: +386 (0)1 / 513 8116	Slovenia	GIRIT CELADON Ltd. 12 H'aomant Street IL-42505 Netanya Phone: +972 (0)9 / 863 39 80	Israel
KONING & HARTMAN B.V. Toluwelaan 31 BE-1800 Wilvoorde Phone: +32 (0)2 / 257 02 40	Belgium	PROVENDOR OY Teljänkatu 8 A3 FIN-28130 Pori Phone: +358 (0) 2 / 522 3300	Finland	HIFLEX AUTOM. B.V. Wolwevestraat 22 NL-2984 CD Ridderkerk Phone: +31 (0)180 / 46 60 04	Netherlands	Beijer Electronics Automation AB Box 426 SE-20124 Malmö Phone: +46 (0)40 / 35 86 00	Sweden	CEG LIBAN Cebaco Center/Block A Autostrade DORA Lebanon-Beirut Phone: +961 (0)1 / 240 445	Lebanon
INEA RBT d.o.o. Stegne 11 SI-1000 Ljubljana Phone: +386 (0)1 / 513 8116	Bosnia and Herzeg.	LITECO A.B.E.E. 5, Mavrogenous Str. GR-18542 Piraeus Phone: +30 (0)211-1206-900	Greece	KONING & HARTMAN B.V. Haarlerbergweg 21-23 NL-1101 CH Amsterdam Phone: +31 (0)20 / 587 76 00	Netherlands	OMNI RAY AG Im Schörl 5 CH-8600 Dübendorf Phone: +41 (0)44 / 802 28 80	Switzerland	ADROIT TECHNOLOGIES 20 Waterford Office Park 189 Witkoppen Road ZA-Fourways Phone: +27 (0)11 / 658 8100	South Africa
AKHNATON 4. Andrei Lipachev Blvd., PO Box 21 BG-1756 Sofia Phone: +359 (0)2 / 817 6000	Bulgaria	MELTRADE Ltd. Fertő utca 14. HU-1107 Budapest Phone: +36 1 / 431-9726	Hungary	Beijer Electronics AS Fretchoks 487 NO-3002 Drammen Phone: +47 (0)32 / 24 30 00	Norway	OOO "CSC-AUTOMATION" 4-B, M. Raskolnyoi St. UA-02660 Kiev Phone: +380 (0)44 / 494 33 44	Ukraine		
INEA CR Losinjka 4 a HR-10000 Zagreb Phone: +385 (0)1 / 36 940 -01/-02/-03	Croatia	TOO Kazpromavtomatika Ul. Zhambyla 28 KAZ-100017 Karaganda Phone: +7 7212 / 50 10 00	Kazakhstan	Fonseca S.A. R. João Francisco do Casal 87/89 PF-3801-997 Aveiro, Esqueira Phone: +351 (0)234 / 303 900	Portugal				
AutoCont C.S. S.R.O. Kafkova 1853/3 CZ-702 00 Ostrava 2 Phone: +420 595 691 150	Czech Republic	Beijer Electronics SIA Ritauzmas iela 23 LV-1058 Riga Phone: +371 (0)6 / 784 2280	Latvia	Sirius Trading & Services R. Aleea Lacul Morii Nr. 3 RO-060841 Bucuresti, Sector 6 Phone: +40 (0)21 / 430 40 06	Romania				



Version check

Mitsubishi Electric Europe B.V. / FA - European Business Group / Gothaer Straße 8 / D-40880 Ratingen / Germany / Tel.: +49(0)2102-4860 / Fax: +49(0)2102-4861120 / info@mitsubishi-automation.com / www.mitsubishi-automation.com

Art. no. 170021-H / 08.2013 / Specifications subject to change / All trademarks and copyrights acknowledged.

